

Instruction Manual

Flow Measurement Transmitter NivuFlow 750/700



Firmware Revision: 3.1x

Revised manual

Document revision: rev. 01 / 22.06.2021

Original Manual: German / rev. 01 as of 03.04.2021

measure analyse optimise

NIVUS AG, Switzerland

Burgstrasse 28
8750 Glarus, Switzerland
Phone +41 55 6452066
Fax +41 55 6452014
swiss@nivos.com
www.nivos.de

NIVUS, Austria

Mühlbergstraße 33B
3382 Loosdorf, Austria
Phone +43 2754 5676321
Fax +43 2754 5676320
austria@nivos.com
www.nivos.de

NIVUS Sp. z o.o., Poland

ul. Hutnicza 3 / B-18
81-212 Gdynia, Poland
Phone +48 58 7602015
Fax +48 58 7602014
biuro@nivos.pl
www.nivos.pl

NIVUS, France

12 rue Principale
67870 Bischoffsheim, France
Phone +33 388 999284
info@nivos.fr
www.nivos.fr

NIVUS Ltd., United Kingdom

Wedgewood Rugby Road
Weston under Wetherley
Royal Leamington Spa
CV33 9BW, Warwickshire
Phone +44 8445 332883
nivosUK@nivos.com
www.nivos.com

NIVUS Middle East (FZE)

Building Q 1-1 ap. 055
P.O. Box: 9217
Sharjah Airport International
Free Zone
Phone +971 6 5578224
Fax +971 6 5578225
middle-east@nivos.com
www.nivos.com

NIVUS Korea Co. Ltd.

#2301, M-Dong Technopark IT Center,
32 Songdogwahak-ro Yeonsu-gu,
INCHEON, Korea 21984
Phone +82 32 2098588
Fax +82 32 2098590
jhwon@nivuskorea.com
www.nivuskorea.com

NIVUS Vietnam

238/78 Phan Trung Street,
Tan Tien Ward, Bin Hoa City,
Dong Nai Province, Vietnam
Phone +84 94 2623979
jhwon@nivuskorea.com
www.nivos.com

Copyrights and property rights

This document and its contents are proprietary to NIVUS GmbH and are not to be reproduced or copied without the express written permission of NIVUS GmbH.

Violations oblige to compensation.



Important Note

This instruction manual may exclusively - even in parts - be copied or translated in any other way with the express written consent of NIVUS GmbH.

Translation

If the device is sold to a country in the European Economic Area (EEA) this instruction manual must be translated into the language of the country in which the device is to be used.

Should the translated text be unclear, the original instruction manual (German) must be consulted or one of the legally associated companies and subsidiaries of NIVUS group contacted for clarification.

Copyright

No part of this publication may be reproduced, transmitted, sold or disclosed without prior permission. Damages will be claimed for violations.

All rights reserved.

Names

The use of general descriptive names, trade names, trademarks and the like in this manual does not entitle the reader to assume they may be used freely by everyone. They are often protected registered trademarks even if not marked as such.

Revision History

Rev.	Modifications/Changes	Person in charge	Date
01	Complete revision: addition of various features and functions such as Type M9, regulator operation, integrated mobile communications modem and cyclic operation, layout modifications etc.	MoG	22.06.2021
00	First version	DMR	08.05.2015

Table 1 Overview

Table of Contents

COPYRIGHTS AND PROPERTY RIGHTS	3
REVISION HISTORY	4
GENERAL	11
1 About this manual	11
1.1 Applicable documentation	11
1.2 Signs and definitions used	12
1.3 Abbreviations used	12
2 Connections and Control elements	12
2.1 Power supply	12
2.2 NivuFlow control elements	13
2.3 Tasks of control elements	13
2.4 Interfaces	14
SAFETY INSTRUCTIONS	15
3 In general: Used symbols and signal words	15
3.1 Valuation of the accident level	15
3.2 Warning notices on the product	16
4 Safeguards and Precautions	16
5 Warranty	17
6 Liability disclaimer	17
7 Use in accordance with the requirements	18
8 Ex Protection	18
9 User's Responsibilities	19
10 Personnel requirements	20
DELIVERY, STORAGE AND TRANSPORT	21
11 Delivery	21
12 Reception inspection	21
13 Storing	21
14 Transport	21
15 Return	21

PRODUCT SPECIFICATION	22
16 Product construction and overview	22
16.1 Dimensions of enclosure	23
16.2 Connectable sensors	24
16.3 Device identification	24
17 Specifications	25
18 Configuration	27
18.1 Device Types	27
18.2 Add-On Function Licences	28
FUNCTIONAL PRINCIPLE	29
19 Operating Range	29
20 Functional Principles	29
20.1 Flow Velocity Measurement	29
20.1.1 Ultrasonic Cross Correlation	29
20.2 Level measurement.....	31
20.2.1 External level sensor	31
20.2.2 Water ultrasound	32
20.2.3 Pressure	33
INSTALLATION AND CONNECTION	34
21 General Installation Instructions	34
21.1 Hints on how to avoid electrostatic discharge (ESD)	34
21.2 Installation and Mounting versions.....	34
21.3 Choosing the installation place	36
21.4 Transmitter fastening on DIN rail in control cabinets.....	36
21.5 Field enclosure fastening and preparing electric installation.....	36
22 Electric Installation	38
22.1 Connection to the Terminal Blocks.....	39
22.2 Plans of terminal connections	40
22.3 Switching on voltage supply.....	43
22.3.1 Power supply DC.....	43
22.3.2 Power supply AC	44
22.4 Relays	45
23 Installation and connections of sensors	45
23.1 Sensor Installation Principles	45
23.2 Cable and cable lengths for sensor connection	46
23.3 Connection of iXT and MPX.....	47
23.4 Sensor Connection at NivuFlow.....	50
23.4.1 Connecting flow velocity sensors	51
23.4.2 Connection of level sensors	52
23.4.3 Special Points for Sensor Connection in Ex-Area Zone 1	53

24 Controller operation	54
24.1 General	54
24.2 Control Section Setup	56
24.3 Wiring Diagrams for Control Operation	57
24.4 Control Algorithm	59
25 Special Functions NivuFlow 750 Type M9.....	59
25.1 General	59
25.2 Connection of Flow Velocity Sensors.....	60
25.3 Connection of Level Sensors	62
25.4 Connecting the Ex Separation Module/Multiplexer to NivuFlow 750 type M9	64
Transmitters	64
26 Overvoltage Protection.....	65
OPERATION START-UP	71
27 Notes to users	71
28 Operation Basics.....	72
28.1 Display Overview	72
28.2 Using the Control elements.....	72
28.3 Use/Entry using the letter block	74
28.4 Use/Entry using the numeric keypad	75
28.5 Revision of parameters	75
28.6 Menus	75
MAIN SCREEN	77
29 General Overview	77
30 Display Field Flow	79
31 Display Field Level (except combi measurement place NF 750 Type M9).....	80
32 Display Field Velocity (except combi measurement place NF 750 Type M9).....	81
33 Display Field Temperature (except combi measurement place NF 750 Type M9)	82
34 Display Field Total.....	82
35 Display Field Trend/Hydrograph	83
36 Display Field Measurement Place of Combi Measurement Place (with NF 750 Type M9 with several Measurement Places).....	84
SETTING PARAMETERS	85
37 Basics.....	85
37.1 Save Parameters	85
37.2 Change Password.....	86

38	Parameter Functions	86
38.1	Main Menu	86
38.2	Functions of the first Menu Level	87
38.2.1	Menu - Application	87
38.2.2	Menu - Data	88
38.2.3	Menu - System	88
38.2.4	Menu - Communication	89
38.2.5	Menu - Display	90
38.2.6	Menu - Connections	90
39	Parameter Description	90
39.1	Setting the Measurement Place Parameters (Menu Application)	90
39.1.1	Active/Activation of Measurement Places (only for NivuFlow 750 Type M9 with multiple Measurement Places)	91
39.1.2	Name of the measurement place	91
39.1.3	Channel Profiles	92
39.1.4	Sludge Level	98
39.1.5	3D Preview	98
39.1.6	Low-flow suppression	98
39.1.7	Damping	99
39.1.8	Stability	99
39.2	Setting Parameters in Menu h-Sensors	100
39.2.1	h-Sensor Types	100
39.2.2	Definition of Measurement Ranges	102
39.2.3	Overlapping	106
39.2.4	Deviation (abs.)	106
39.2.5	Fallback	107
39.3	Setting Parameters in Menu v-Sensors	107
39.3.1	Number of Flow Velocity Sensors	108
39.3.2	Sensor Types	108
39.3.3	Mounting Position of Sensors	109
39.3.4	Weighting	114
39.3.5	v-Determination low Levels	115
39.3.6	Limiting the Velocity Evaluation	117
39.3.7	Data Transmission Rate	117
39.4	Setting Parameters of Inputs and Outputs (analogue and digital)	118
39.4.1	Analogue Inputs	118
39.4.2	Analogue Outputs	120
39.4.3	Digital Inputs	122
39.4.4	Digital Outputs	125
39.5	Setting Parameters of the Q-Controller	130
39.6	Diagnostics	133

40	Parameter Menu Application/Combi	133
40.1	General Information	133
40.2	Name of the measurement place	134
40.3	Calculation	134
40.4	Damping	135
40.5	Stability	135
41	Parameter Menu Data	136
41.1	Trend	136
41.2	Total	138
41.3	Day Totals	138
41.4	USB Stick	140
41.5	Data Memory (Internal)	146
41.5.1	Basic Functions	146
41.5.2	Powerdown Mode / Clock Control (function can be added via licence)	146
41.6	Operating Hours	151
42	Parameter Menu System	152
42.1	Information	152
42.2	Region Settings	152
42.2.1	(Operating) Language	153
42.2.2	Date Format	153
42.2.3	Units	153
42.2.4	Data Units	154
42.3	Time/Date	156
42.4	Error Messages	157
42.5	Service	157
42.5.1	Change (System) Password	158
42.5.2	Feature Unlock	158
42.5.3	Restart	159
42.5.4	Restart Measurement	159
42.5.5	Parameter Reset	159
42.5.6	Disable Coin Cell	160
42.5.7	Update NivuFlow	160
42.5.8	Update h-Sensor	161
42.5.9	Update v-Sensor	161
43	Parameter Menu Communication	161
43.1	TCP/IP	162
43.2	Web Server	163
43.3	Data Transmission	164
43.4	Alert	168
43.5	HART (function can be added via licence)	169
43.6	Modbus	169

44	Parameter Menu Display	171
45	Parameter Menu Connections	174
45.1	Common.....	174
45.2	For Transmitters Types S1, SR and M3	174
45.3	For Transmitters Type M9	175
45.4	Baud Rate (all Types).....	178
DIAGNOSTICS		179
46	Basics of the Diagnostics Menu	179
47	Diagnostics h-Sensors	180
48	Diagnostics v-Sensors	181
49	Diagnostics Inputs and Outputs (analogue and digital)	184
49.1	Analogue Inputs	185
49.2	Analogue Outputs	185
49.3	Digital Inputs	187
49.4	Digital Outputs.....	187
50	Diagnostics Q-Controller	189
51	Diagnostics Flow Profile	190
52	Diagnostics Simulation	190
MAINTENANCE AND CLEANING		193
53	Maintenance	193
53.1	Maintenance interval.....	193
53.2	Customer Service Information.....	193
54	Cleaning	194
54.1	Transmitter	194
54.2	Sensors	194
55	Dismantling/Disposal	194
56	Installation of spare parts and parts subject to wear and tear	196
57	Accessories	196
INDEX		197
CREDITS AND LICENCES		201
58	List of references of the licences and codes used	201
APPROVALS AND CERTIFICATES		202

General

1 About this manual



Note

*READ CAREFULLY BEFORE USE!
KEEP IN A SAFE PLACE FOR LATER REFERENCE!*

This instruction manual is for the flow measurement transmitters NivuFlow 750 and NivuFlow 700 (special design: not for German-speaking countries) and is for the intended use of the devices. This manual is oriented exclusively to qualified expert personnel.

Read this instruction manual carefully and completely prior to installation and connection since it contains relevant information on this product. Observe the notes and particularly follow the warning notes and safety instructions.

If you should have problems to understand information contained within this instruction manual contact one of the legally associated companies and subsidiaries of NIVUS group for further support. The companies and subsidiaries of the NIVUS group cannot be held responsible for damage to persons or materials due to incorrectly understood information in this instruction manual.



Note

*For the sake of simplicity, in this instruction manual only the NivuFlow 750 is mentioned usually. Data, drawings and explanations, however, are always applicable even for NivuFlow 700 transmitters presumed the transmitters are equipped accordingly.
Depending on the equipment/transmitter type, the descriptions and display illustrations may differ from those shown in the instruction manual.
Only the NivuFlow 750 type M9 has special equipment in the form of several measurement places or a combi measurement place; a controller may be available with the NivuFlow 750 Type SR, M3 or M9 transmitters. The illustrations and descriptions for these equipments are not valid for the other transmitter types.*

1.1 Applicable documentation

For the installation and operation of the complete system extra instruction manuals or technical descriptions may be required apart from this manual.

- Technical Instructions for Correlation Sensors and external Electronic Box
- Installation Instruction Correlation and Doppler Sensors
- Technical Description Ex-Separator Module iXT
- Technical Description for Multiplexer MPX
- Instruction Manual for i-Series Intelligent Sensors
- Technical Information USB HART Modem
- Technical Instructions NIVUS MODBUS TCP/RTU Application Interface for measurement transmitters of the series NivuFlow 5xx, 6xx, 7xx and Energy Saver

These manuals are provided with the auxiliary units or sensors and/or are available as download on the NIVUS homepage.

1.2 Signs and definitions used



Image	Meaning	Remark
	(Action) Step	Action to be performed by you. Note the numbering of action steps. Observe the order of the working steps.
	Cross-reference	Refers to further or detailed information.
>Text<	Parameter or Menu	Indicates a parameter or a menu that is selected or described.
	Reference to document	Refers to an accompanying documentation.

Table 1 Structural elements within the manual

1.3 Abbreviations used

Colour code for wires, single conductors and components

The abbreviations of colours, wire and components follow the international colour code according to IEC 60757.

BK	Black	BN	Brown	RD	Red
OG	Orange	YE	Yellow	GN	Green
BU	Blue	VT	Violet	GY	Grey
WH	White	PK	Pink	TQ	Turquoise
GNYE	Green/Yellow	GD	Gold	SR	Silver

2 Connections and Control elements

2.1 Power supply

The connection for power supply is located on the lower part of the terminal block X1.

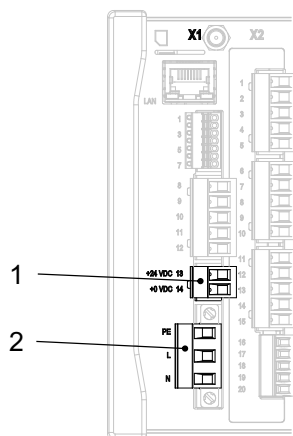

- 1 Power Supply DC/DL
- 2 Power Supply AC and protective conductor

Fig. 2-1 Electrical connections of power supply

 You can find a detailed connection plan in chapter “22.2 Plans of terminal connections”.

2.2 NivuFlow control elements

The NivuFlow is operated completely in dialogue mode supported by the graphs on the display. To select individual menus and sub-menus use the rotary pushbutton as well as the both function keys.

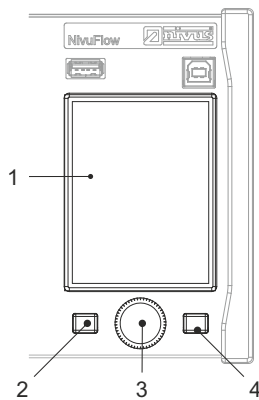

- 1 Graphic display
- 2 Left function key
- 3 Rotary pushbutton
- 4 Right function key

Fig. 2-2 Control elements

2.3 Tasks of control elements

Colour display

You can read all settings, when parameter setting and in diagnostics.

Left function key (Menu and/or Back)

This key (Menu) takes you from the main display to the main menu. The same key (Back) is also used to exit the main menu and the submenus.

Rotary pushbutton

Use the rotary pushbutton to enter specific sub-menus. The functions can be selected using the rotary pushbutton as well.

- Select the desired parameter or menus
- Navigation through the sub-menus and settings
- Selection of letters or numbers for parameter setting

Right function key (Input and/or Tab)

This key is used to confirm value entries (via numeric keys or letter keys).

For some parameters the right function key can be used as >Tab<. This Tab function is always available when digits are visible in the upper right corner of the display. Then the Tab function is used to switch between pages/displays. This applies to the following settings:

- Menu >Application<
 - Selection of v-sensors (nur bei NivuFlow 750 Typ M3/M9)
 - Diagnostics v-sensors (nur bei NivuFlow 750 Typ M3/M9)
 - Selection of analog inputs (AI)
 - Selection of analog outputs (AO)
 - Selection of digital inputs (DI)

- Selection of digital outputs (DO)
- Menu >Data< (only for NivuFlow 750 Type M3/M9)
 - Selection of screen with trend and day totals for measurement place 1/2/3 and combi measurement place
- Main screen (only for NivuFlow 750 Type M3/M9)
 - Selection of screen for measurement place 1/2/3 and combi measurement place

While programming more than one input/output or more than one flow velocity sensor the right function key can be used to jump across from one input/output or sensor to the next one.

⇒ You will find a description on how to use the control elements in chapter “28 Operation Basics”.

2.4 Interfaces

The transmitter has several interfaces on the front panel.

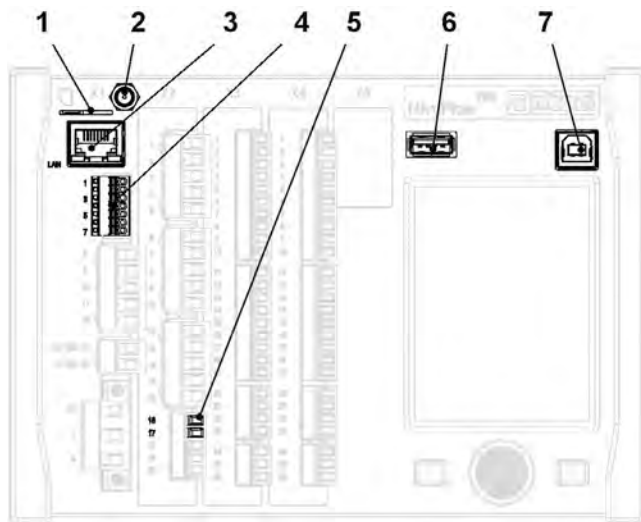

- 1 Slot for SIM card (alternative data transmission via internal 2G/3G/4G modem)
- 2 Antenna socket (for internal 2G/3G/4G modem)
- 3 Network interface (LAN)
- 4 BUS interface (RS485/RS232)
- 5 HART interface
- 6 USB-A interface (data transfer, parameter backup, device update)
- 7 USB-B interface (service mode)

Fig. 2-3 Available interfaces

⇒ Descriptions of the individual interfaces see chapter “43 Parameter Menu Communication”.

Safety Instructions

3 In general: Used symbols and signal words

3.1 Valuation of the accident level



The general warning symbol indicates the risk of personal injuries or death. In the text section the general warning symbol is used in conjunction with the signal words described below.

DANGER

Warnings in high degree of risk



Indicates a high-risk, **imminently** hazardous situation which will result in death or serious injury if not avoided.

WARNING

Warnings in medium degree of risk



Indicates a **possible** danger with medium risk which may result in a life-threatening situation or (severe) bodily injury if it is not avoided.

CAUTION

Warnings in low-risk or property damages



Indicates a **possible** danger with moderate risk which may result in minor or moderate personal injury or material damage if not avoided.

WARNING

Danger by electric voltage



Indicates a hazard with a high risk of electric shock which may result in a life-threatening situation or (severe) bodily injury if it is not avoided.



Important Note

Contains information that should be highlighted.

Indicates a potentially damaging situation which can result in a damage of the product or an object in its environment.



Note

Contains information and facts.

3.2 Warning notices on the product



General warning label

This symbol is for operators to refer to this instruction manual.

Observing the information contained therein is required in order to maintain protection measures provided by the instrument during installation procedures and operation.



Protective conductor

This symbol refers to the protective conductor of the unit.

Depending on the mode of installation the instrument shall be operated solely connected to an appropriate protective conductor according to applicable laws and regulations.

4 Safeguards and Precautions

Working with NIVUS instruments requires to observe and to follow the safety measures and precautions below generally and at any time. These notes and warnings will not be repeated for each description within the document.

WARNING

Check danger due to explosive gases



Before starting assembly, installation and maintenance work, be sure to check that all regulations on safety at work have been observed and that there is no possible risk of explosive gases. Use a gas warner for the check.

When working in the sewer system, make sure that no electrostatic charge can occur:

- *Avoid unnecessary movements to reduce the building-up of static charges.*
- *Discharge any static electricity present on your body before you start installing the sensor.*

Disregarding may result in personal injury or damage to the system.

WARNING

Germ contamination



Parts can be contaminated with dangerous germs, especially if the sensors are used in waste water applications. Therefore, appropriate precautions must be taken when contacting cables and sensors.

Wear protective clothing.

WARNING

Observe occupational safety regulations



Before starting installation work, observing the work safety regulations need to be checked.

Disregarding may lead to personal injury.

WARNING

Do not disable safety devices



It is strictly prohibited to disable the safety devices or to change the way they work.

Disregarding may lead to personal injury.

WARNING



Disconnect the systems from mains.

Maintenance, cleaning and/or repairs (by qualified personnel only) may only be performed when de-energised.

Disregarding may lead to electric shocks!



Important Note

The entire measurement system shall be installed and put into operation only by trained expert personnel.

Integrated buffer battery

The integrated buffer battery may only be exchanged by NIVUS staff or personnel authorised by NIVUS. Infringements lead to a limitation of the warranty (see chap. "5 Warranty").

5 Warranty

The device has been functionally tested before delivery. If it is used as intended (see chap. "7 Use in accordance with the requirements") and the operating instructions, the applicable documents (see chap. "1.1 Applicable documentation") and the safety notes and instructions contained therein, are observed, no functional restrictions are to be expected and perfect operation should be possible.



Please also note in this regard the next chap. "6 Liability disclaimer".



Limitation of warranty

In the event of non-compliance with the safety instructions and instructions in this document, the companies of the NIVUS group of companies reserve the right to limit the warranty.

6 Liability disclaimer

The legally associated companies and subsidiaries of NIVUS group assume no liability

- for damages owing to **a change** of this document. The legally associated companies and subsidiaries of the NIVUS group reserve the right to change the contents of this document and this disclaimer at any time and without any notice.
- for damages to persons or objects resulting from **failure to comply** with applicable **regulations**. For connection, commissioning and operation of the device all available information and higher legal regulations (in Germany e.g. VDE regulations) such as applicable Ex regulations as well as safety requirements and regulations in order to avoid accidents shall be adhered to.
- for damages to persons or objects resulting from **improper use**. For safety and warranty reasons, all internal work on the instruments beyond from that involved in normal installation and connection, must be carried out only by qualified NIVUS personnel or persons or companies authorised by NIVUS.
- for damages to persons or objects resulting from the use of instruments in technically **imperfect** condition.
- for damages to persons or objects resulting from the use of instruments **not in accordance with the requirements**.
- for damages to persons or objects resulting from **failure to comply** with **safety information** contained within this instruction manual.
- for missing or incorrect measurement values or resulting consequential damages due to **improper installation**.

7 Use in accordance with the requirements



Note

The instrument is intended solely for the purpose described below.

Modifying or using the instruments for any other purposes without the written consent of the legally associated companies and/or subsidiaries of NIVUS group will not be considered as use in accordance with the requirements.

The legally associated companies and subsidiaries of NIVUS group cannot be held responsible for any damage resulting from improper use.

The user alone bears any risk.

The permanent flow meter **NivuFlow 750** including the accompanying sensors is designed for continuous flow measurement of slight to heavily polluted media in **part filled and full** channels, pipes and similar.

The permanent flow meter **NivuFlow 700** including the accompanying sensors is designed for continuous flow measurement of slight to heavily polluted media in **full** channels and pipes. The NivuFlow 700 is a special design and is not manufactured for German-speaking countries.

The flow meter is designed and manufactured in accordance with the current state of the art and with the recognised safety rules and regulations applicable at the time this document is issued. Danger to persons or material damage cannot be completely ruled out, however.

The maximum permissible limit values as specified in chapter "17 Specifications" shall be necessarily observed. Any case varying from these conditions which is not approved by NIVUS GmbH in written form is left at the owner's risk.

8 Ex Protection

The NivuFlow 750/700 transmitter can be used in conjunction with an Ex Separation Module Type iXT0 and the POA, CS2 and OCL sensors (which must also have Ex approval) as well as with Ex-approved CSM and DSM-L0 sensors (in combination with the EBM Electronic Box) for use in areas with Zone 1 explosive atmospheres. Here, the Ex-approved POA, CS2 and OCL sensors or the Ex-approved CSM and DSM-L0 sensors (in combination with the EBM Electronic Box) are installed directly in Ex zone 1, while the **transmitter** and the **Ex Separation Module** must be installed in **non-Ex areas**. The **EBM Electronic Box** can be installed directly in the Ex area Zone 1 **with** the associated **Ex approval**; **without** the Ex approval it must be located **outside** the Ex zone.

The connection diagrams can be found in the corresponding technical description / installation instructions for the POA, CS2 and OCL sensors or the CSM and DSM-L0 sensors (in combination with the EBM Electronic Box) or the iXT0 Ex Separation Module.

Sensor / Ex Separation Module Approvals



See "Technical Description for Correlation Sensors" or "Technical Description iXT Ex Separation Module".



Validity of the Ex Approval

The Ex approval is only valid in conjunction with the corresponding marking on the nameplate of transmitter and the sensors.



Declarations of Conformity and Test Certificates

For installation and commissioning the conformity certificates as well as the test certificates issued by the respective authorities shall be followed.

The combination of NivuFlow and the iXT Ex Separation Interface is adjusted solely to NIVUS correlation sensors POA, CS2, CSM and DSM, ultrasonic sensor OCL, i-series sensors i-03/i-06/i-10/i-15 and pressure probe NivuBar Plus as well as the Electronic box Type EBM regarding the intrinsically safe system review according to EN60079-25.

In the event of using sensors by third-party manufacturers the operator shall carry out a system review according to EN 60079-25!

The required specifications of the iXT Ex Separation Interface can be found in the according EC type examination certificate.

9 User's Responsibilities



Strictly observe and comply with guidelines and requirements

In the EEA (European Economic Area) national implementation of the framework directive 89/391/EEC and corresponding individual directives, in particular the directive 2009/104/EC concerning the minimum safety and health requirements for the use of work equipment by workers at work, as amended, are to be observed and adhered to.

In Germany the Industrial Safety Ordinance must be observed.

Make sure to have a local operating permit available and observe the associated conditions. In addition to this you must observe environmental requirements and local laws on the following points:

- Personnel safety (accident prevention regulations)
- Safety of work materials and tools (safety equipment and maintenance)
- Disposal of products (laws on wastes)
- Disposal of materials (laws on wastes)
- Cleaning (cleansing agents and disposal)

Connections

Operators shall make sure prior to operating the instrument that during installation and initial start-up the local regulations (such as regulations for electrical connection) are observed.

Keep the manual

Keep this manual in a safe place and make sure it is available for the users of this product at any time.

Provide the manual

In case of selling the instrument this instruction manual shall be provided to the purchaser since it is a part of the standard delivery.

10 Personnel requirements

Installation, commissioning and maintenance shall be executed only by personnel meeting the demands as follows:

- Expert personnel with relevant training and appropriate qualification
- Personnel authorised by the plant operator



Qualified personnel

within the context of this documentation or the safety notes on the product itself are persons who are sufficiently familiar with installation, mounting, starting up and operation of the product and who have the relevant qualifications for their work; for example:

- I. Training, instruction or authorisation to activate/deactivate, isolate, ground, and mark electric circuits and devices/systems according to the safety engineering standards.*
 - II. Education and instruction according to the standards of safety engineering regarding the maintenance and use of adequate safety equipment.*
 - III. First aid training.*
-

Delivery, Storage and Transport

11 Delivery

The standard delivery of the NivuFlow 750/700 contains:

- A transmitter type NivuFlow 750 or 700 corresponding to the shipping documents.
- A 2G/3G/4G antenna: Enclosed as a magnetic base antenna in the case of transmitters for mounting on DIN rails or attached as an adhesive antenna inside the transmitter in the case of transmitters mounted in NIVUS field enclosures.
- The instruction manual including the certificate of conformity and approvals. It contains any relevant information on how to operate the NivuFlow.

Check additional accessories depending on your order and according to the delivery note.

12 Reception inspection

Check the packaging for visible damage immediately after receipt. Any possible damage in transit shall be instantly reported to the carrier. Furthermore a written report shall be sent to NIVUS GmbH in Eppingen.

Incomplete deliveries shall be reported in writing either to your local representative or directly to the NIVUS head office in Eppingen within two weeks.



Important Note

Objections cannot be rectified later.

13 Storing

Observe the minimum and maximum values on environmental conditions such as temperature and humidity according to chap. "17 Specifications".

The NivuFlow shall be protected from corrosive or organic solvent vapours, radioactive radiation as well as strong electromagnetic radiation.

Use the original packaging for storage.

14 Transport

Do not expose the system to heavy shocks or vibrations.

Use the original packaging for transport.

Otherwise, the same rules apply with regard to external influences as for storage (see chap. "13 Storing").

15 Return

In case of a required reshipment return the unit at customer cost to NIVUS GmbH in Eppingen using the original packaging.

Insufficiently franked shipments will not be accepted!

Product specification

16 Product construction and overview

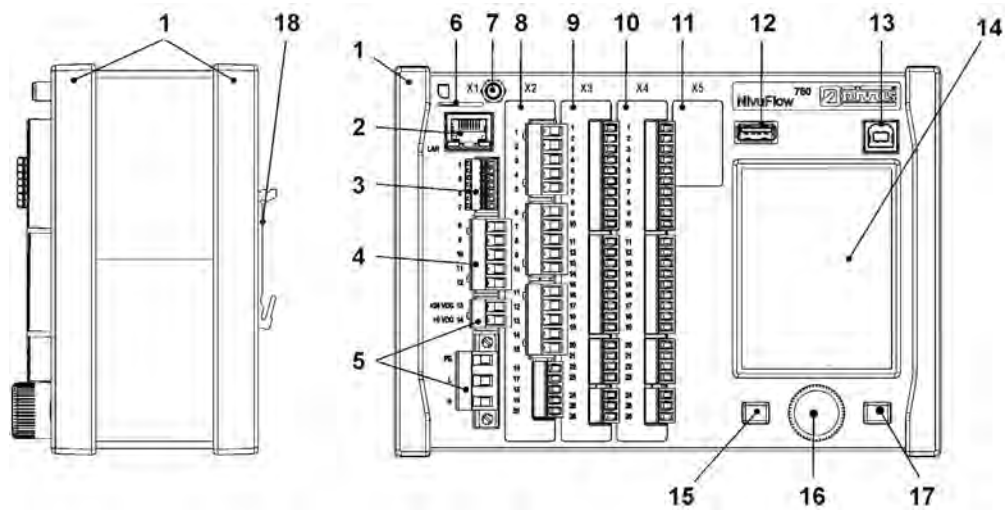

- 1 Trims/cover strips (only for installation in control cabinets; type of installation E0)
- 2 Interface (LAN)
- 3 Bus interface (RS485/RS232)
- 4 Connection air ultrasonic sensor (RS485)
- 5 Power supply
- 6 Slot for SIM card (alternative data transmission via internal 2G/3G/4G modem)
- 7 Antenna socket (for internal 2G/3G/4G modem) (SMA, female)
- 8 Plug-in X2 - v-sensor 1 (and v-sensor 2/3 - NivuFlow 750 type M3/M9)
- 9 Plug-in X3 - NivuFlow 750 type SR/M3/M9
- 10 Plug-in X4 - NivuFlow 750 type M3/M9
- 11 Plug-in X5 - reserve (not wired)
- 12 USB-A-interface (data transfer, parameter backup, device update)
- 13 USB-B-interface (service mode)
- 14 Graphic display
- 15 Function key
- 16 Rotary pushbutton
- 17 Function key
- 18 DIN rail fastening (for installation in NIVUS field enclosure; type of installation E1: fastened elevated by 6 mm)

Fig. 16-1 Device setup NivuFlow 750/700; type of installation E0/E1

16.1 Dimensions of enclosure

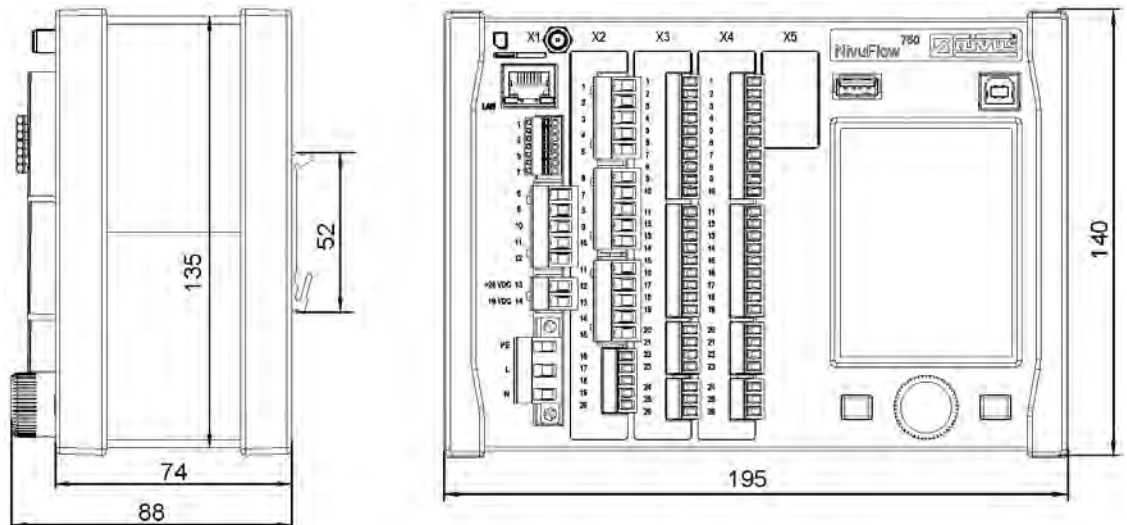
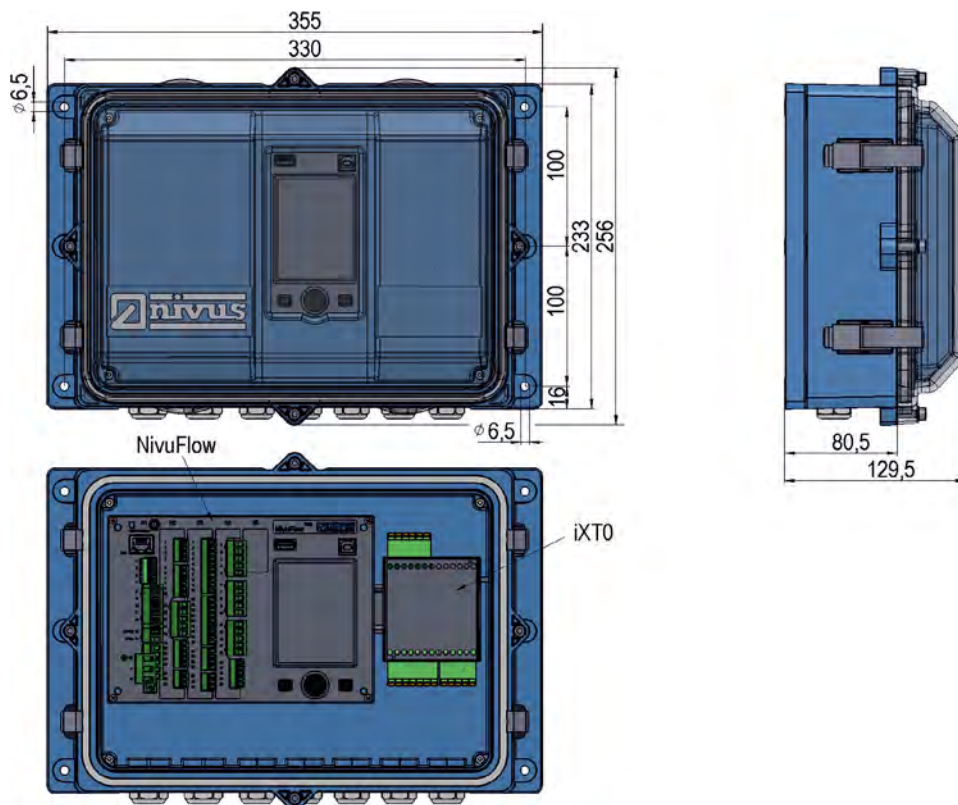

Fig. 16-2 Dimensions of NivuFlow 750/700; type of installation E0



Info: Bottom view without cover (NivuFlow and iXT visible)

Fig. 16-3 Dimensions of field enclosure of NivuFlow (with iXT option); type of installation E1

16.2 Connectable sensors

The image below provides an overview on the connectable sensors.

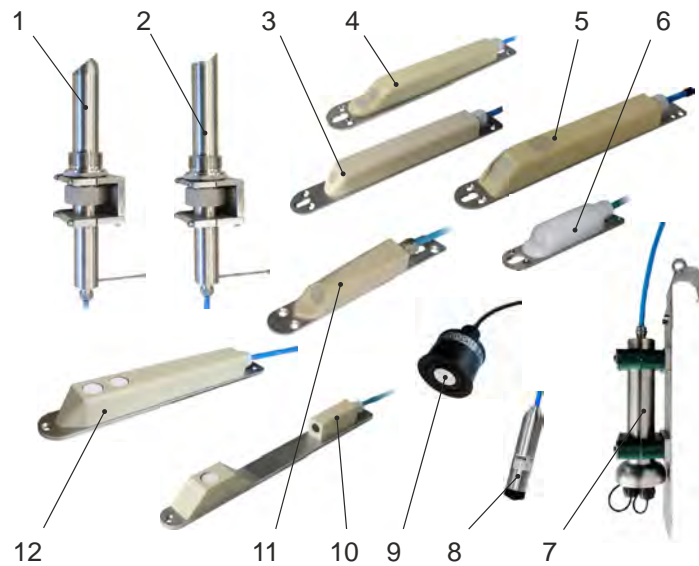

- 1 Pipe sensor, type CS2 (with sensor screw connection and retaining element)
- 2 Pipe sensor, type POA (with sensor screw connection and retaining element)
- 3 Flow velocity sensor (wedge), types POA-V200/V2D0
- 4 Flow velocity sensor (wedge), types POA-V2H1/V2U1
- 5 Flow velocity sensor (wedge), type CS2
- 6 Mini flow velocity sensor (wedge), type CSM-V100 (connection via EBM required)
- 7 Electronic box, type EBM
- 8 Level-Pressure sensor, type NivuBar Plus
- 9 i-series ultrasonic sensor NMI0, types i-03, i-06, i-10 and i-15
- 10 Ultrasonic level sensor, type DSM (connection via EBM required)
- 11 Mini flow velocity sensor (wedge), type CSM-V1D0 (connection via EBM required)
- 12 Air ultrasonic sensor, type OCL-L1

Fig. 16-4 Connectable sensors

16.3 Device identification

The instructions contained within this manual are valid only for the type of device specified on the title page.

The name plate is fixed on the side of the enclosure and contains the following:

- Name and address of NIVUS GmbH
- CE label
- Information on type and series incl. article and serial number
- Year of manufacture: the first four digits of the serial number represent the year and the week number of manufacture (2114.....)
- Power supply (see article number and chap. "18.1 Device Types")

In case of enquiries and ordering replacement parts it is important to specify article number as well as the serial number of the respective transmitter or sensor. This ensures correct and quick processing.



Note

Check the delivered instrument for accordance with your order by identifying the nameplate.

Check the nameplate for correct specification of the power supply (bottom left area).



The declaration of conformity is located at the end of the manual.

Nameplates



Fig. 16-5 Nameplate AC version



Fig. 16-6 Nameplate DC version

17 Specifications

Power supply	100...240 V AC, -15 % / +10 %, 47...63 Hz or 10...35 V DC
Supply connection	AC: Plugged and screwed tension clamp terminal block DC: Plugged tension clamp terminal block
Max. power consumption	AC: 30 VA / DC: 20 W
Typ. power consumption	1x POA-V2U1 + 1x i-sensor + 1 relay energised, + 1x iXT0, 230 V AC: 14 W (rounded)
Enclosure	DIN rail Material: aluminium and plastic Weight: approx. 1300 g Field enclosure Material: polycarbonate PC Weight: approx. 3200 g (incl. NF750 and iXT0 211) Dimensions see chap. 16.1.

Protection	DIN rail IP20 Field enclosure IP67 (option IP68)
Operating conditions	Protection class I Overvoltage category II Pollution degree 2
Altitude	AC unit for use in altitudes up to 3000 m above MSL. At relay voltages >150 V the use is restricted to an altitude of max. 2000 m above MSL (AC and DC units)
Operating temperature	DC: -20...+70 °C AC: -20...+65 °C
Storage temperature	-30...+80 °C
Max. ambient temp. for installation and operation	+50 °C
Max. humidity	80 %, non-condensing
Display	TFT full graphic colour daylight display, 240x320 pixel, 65536 colours
Programming	Dialog mode using rotary pushbutton and two function keys, in English, German, French, Italian, Spanish, Portuguese, Swedish, Danish, Finnish, Polish, Hungarian, Romanian, Czech, Russian, Korean and Chinese
Connection	<ul style="list-style-type: none"> - In general: Plug with spring-cage terminal clamps - Power supply DC: Plugged and screwed tension clamp terminal block
Inputs	<ul style="list-style-type: none"> - 1x 4...20 mA for external level (2-wire probe) - 1x 4...20 mA for external level (2-wire probe; HART) - 1x RxTx-Bus for NIVUS air-ultrasonic sensor type OCL - 1x (for type S1), 4x (for type SR) resp. 7x (for types M3/M9) 0/4...20 mA with 12 Bit resolution for external level, external controller setpoint and data storage of external units, accuracy ± 0.4 % of measuring range final value (20 mA), load 91 Ohm - 2x (for type S1), 7x (for type SR) resp. 10x (for types M3/M9) digital input - 1x (for type S1/SR), 1...3x (for type M3) resp. 3x (for type M9) flow velocity sensor (POA, CS2 or EBM + CSM) or iXT or MPX connectable
Outputs	<ul style="list-style-type: none"> - 2x (for type S1) resp. 4x (for types SR/M3/M9) 0/4...20 mA, load 500 Ohm, 12 Bit resolution, accuracy higher than ± 0.1 % at 20 °C (higher than ± 0.4 % at -20...+70 °C) - 1x bistable relay SPDT (for types S1/SR), maximum load 230 V AC / 2 A (cos φ 0.9), min. switching current 100 mA - 1x (for type S1), 4x (for type SR) resp. 6x (for type M3/M9) relay SPDT, maximum load 230 V AC / 2 A (cos φ 0.9), min. switching current 10 mA
Controller	1x 3-step-controller, quick-close control, adjustable slide valve position in case of error (controller available only for types SR/M3/M9)
Data memory	Internal 1.0 GB, for programming and readings memory for approx. 570.000 data sets (time stamp); read-out via front-side USB stick
Storage cycle	30 seconds to 15 minutes

Communication	<ul style="list-style-type: none"> - Modbus TCP via networks (LAN/WAN, Internet) - Modbus RTU via RS485 or RS232 - Internet via Ethernet - 2G/3G/4G via built-in radio communications modem
----------------------	---------------------------------------------------------------------------------------------------------------------------------------------------------------------------------------------------------------------------------------

Table 17-1 Specifications

Sensors



Observe the specifications of the according sensors as described in the respective instruction manuals or technical descriptions.

18 Configuration

18.1 Device Types

The NivuFlow is available in different versions which mainly vary in terms of the number of connectable sensors and programmable measurement sites. The article number can be found on the nameplate (see "Nameplates" at page 25).

NF7- Transmitter type NivuFlow;
Function extension through software licences (see Chap. 18.2)

NF7-	Construction				
	0	Special construction (only in connection with Type S1)			
	5	For part filled and full pipes, channels and flumes			
	Type				
	S1	1x v-sensor, 1x air-ultrasonic sensor OCL, 2x DI, 2x DO, 2x AI, 2x AO			
	SR	1x v-sensor, 1x air-ultrasonic sensor OCL, 7x DI, 5x DO, 5x AI, 4x AO, integrated 3-step controller			
	M3	3x v-sensor, 1x air-ultrasonic sensor OCL, 10x DI, 6x DO, 8x AI, 4x AO, integrated 3-step controller			
	M9	Via Multiplexer or Ex Separation Interface expandable to a maximum of 9x v-sensor and 3x air ultrasonic sensor OCL; 10x DI, 6x DO, 8x AI, 4x AO, integrated 3-step controller for one measurement site (only in connection to enclosure E0 and 2/3x iXT/MPX)			
	Type of installation				
	E0	DIN rail/panel mounting (cabinet), IP20			
	E1	DIN rail, prepared for mounting into NIVUS field enclosure			
	Power supply				
	A0	100...240 V AC			
	D0	10...35 V DC			
	DL	Clocked cycle and event-based operation, 10...35 V DC			
Firmware extensions					
0	None				
1	HART protocol				
Number of measurement sites					
1	1 measurement site				
2	2 measurement sites (only type M9, enclosure: E0)				
3	3 measurement sites (only type M9, enclosure: E0)				

Table 18-1 Product structuring

18.2 Add-On Function Licences

The transmitter can be equipped with supplementary functions at extra charge. The following function extensions are currently available as (software) licences:

- HART (Slave) Protocol to analogue Output (AO1)
- FTP-Transmission
- Powerdown / Clock Control
- Radio Transmission of Data Depth >Extended<
- Radio Transmission of Data Depth >Expert<



The functions are activated according to Chap. "42.5.2 Feature Unlock".

Functional Principle

19 Operating Range

The NivuFlow 750/700 is a non-portable measurement system for flow measurement. The equipment is conceived preferably for measurements in slight to heavily polluted aqueous liquids with various compositions.

The NivuFlow 750 can be used in part filled and full flumes, channels and pipes featuring various shapes and dimensions. The NivuFlow 700 only in full pipes.

Unit type SR, M3 and M9 are additionally equipped with a 3-step controller to control a slide valve or other actuators.



You can find an overview on **connectable sensors** in chapter “16.2 Connectable sensors”.

Up to 3 POA or CS2 sensors or Electronic Boxes Type EBM with sensors type CSM and DSM can be connected to the device Type **M3** at the same time.

Up to 9 sensors or Electronic Boxes Type EBM can be connected to the device Type **M9** when using MPX or iXT devices. These can be used for 1...3 independent measurement places, provided that the transmitter is equipped with several measurement places per default (see also Chap. “18.1 Device Types”).

The use of several sensors serves to record the flow velocity more accurately at one common measurement place or, in the case of type M9, for the simultaneous recording of two or three different measurement places.

20 Functional Principles

20.1 Flow Velocity Measurement

20.1.1 Ultrasonic Cross Correlation



Note to the ultrasound reflection principle

The measurement method used for flow velocity detection is based on the ultrasound reflection principle. Hence, it is indispensable for the system to work that there are particles in the water, which are able to reflect the ultrasonic signal sent by the sensor (dirt particles, gas bubbles or similar).

The sound transducer has a slope to the flow direction and operates as a flow velocity sensor. Here an ultrasonic burst with a defined angle is sent into the medium. All the particles in the measurement path (air, dirt) reflect a small amount of the ultrasonic signal. The result is a particular signal depending on shape and size of the particles.

Hence, the multitude of the reflected signals results in a reflection pattern (see Fig. 20-1). The sound transducer receives this pattern again, which then is converted into electric signals and will be saved in a built-in digital signal processor (DSP).

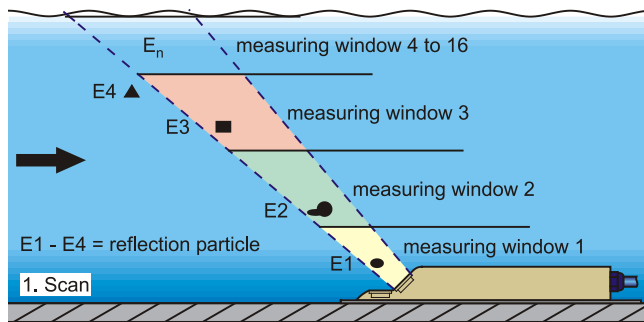

Fig. 20-1 Situation at first signal detection

After a certain period a second ultrasonic burst is sent into the medium. The newly generated reflection signal is saved in the DSP too.

In various flow levels there are different flow velocities (flow velocity profile).

Depending on the level, the reflecting particles' movement away from the first measurement point therefore varies. Hence, a distorted reflection pattern results (see Fig. 20-2).

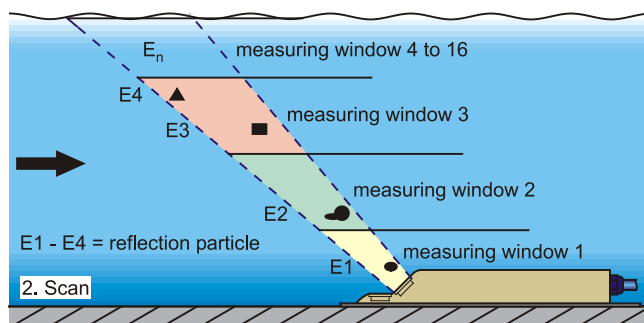

Fig. 20-2 Situation at second signal detection

The DSP checks both received reflection patterns for similarities using the cross correlation method. All existing signal differences (caused by new or rotated particles) are rejected so that two similar but temporarily offset signal patterns are left for velocity evaluation.

Depending on the flow levels both patterns are subdivided into 16 measurement windows. Then, in each measurement window the time shift Δt of the pattern is investigated (see Fig. 20-3).

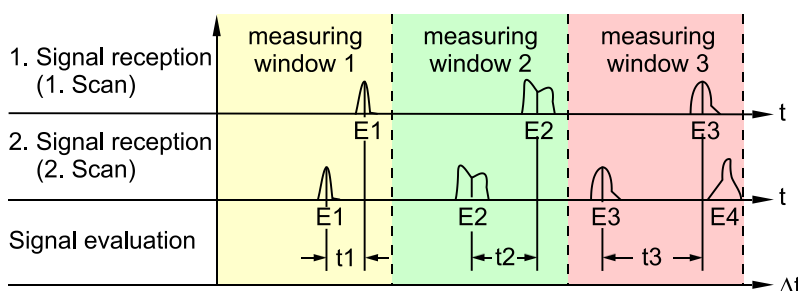

Fig. 20-3 Echo signal images and evaluation

Based on the beam angle, the interval between both transmitted signals and the shift of the signal pattern therefore in each single measurement window the flow velocity can be determined.

It mathematically strings the single flow velocities together which results in the flow profile of the acoustic path.

This velocity profile is indicated directly on the display of the NivuFlow.

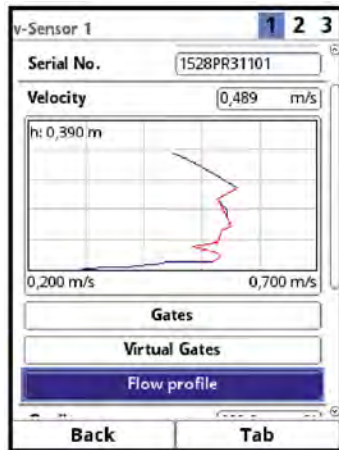

Fig. 20-4 Determined flow profile in the display

If a sufficient calming section is available on the measurement place it is possible to compute a 3-dimensional flow distribution (see Fig. 20-5). The result is based on the geometric data of the flume and the velocity distribution.

In asymmetric flow profiles and heavily structured profiles it is recommended to use more than one flow velocity sensor. The entered sensor positions and the according individual vertical V-profiles are included with the overall 3D-profile and are indicated as well.

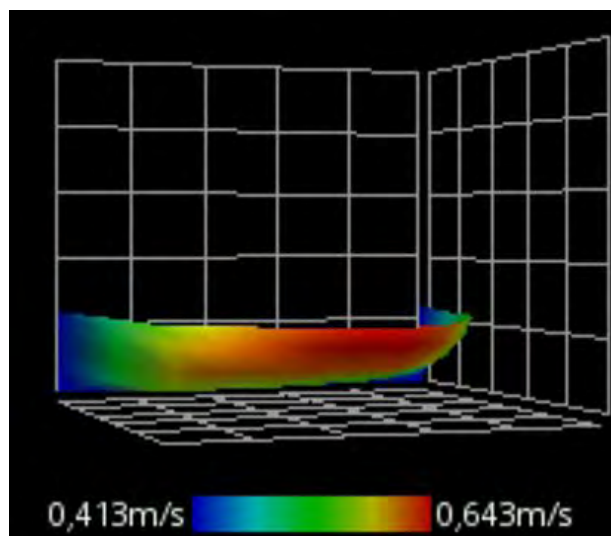

Fig. 20-5 Computed 3-dimensional flow profile

Taking this flow velocity distribution as a basis, the flow rate can be calculated and indicated by considering channel shape, channel dimensions and filling level. This flow rate is available as free programmable analog signal or as impulse signal on the transmitter output.

20.2 Level measurement

20.2.1 External level sensor

Depending on the selected type of level measurement an external 4...20 mA signal may be used for the level (e.g. by using an i-Series sensor).

It is possible to directly connect 2-wire sensors supplied by the NivuFlow (e.g. NivuBar Plus, i-Series sensor). A 4...20 mA signal provided by an external transmitter (such as 4...20 mA from NivuMaster) can be used as well.



Note

i-Series sensors have pre-programmed measurement ranges. For further reference please see the i-Series sensors instruction manual.

i-Sensors can be put into operation even without using a HART modem. To do so enter the sensor's measurement span in the parameter "Value at 20 mA". Depending on the sensor installation height it may be necessary to additionally set a negative offset value.

	i-3	i-6	i-10	i-15
Distance to sensor face in [m] at 4 mA (empty) 0 %	3.0	6.0	10.0	15.0
Distance to sensor face in [m] at 20 mA (full) 100 %	0.125	0.300	0.300	0.500
Max. possible measurement span (value at 20 mA) in [m]	2.875	5.7	9.7	14.5

Table 20-6 Measurement span of i-Sensors

20.2.2 Water ultrasound

Depending on the sensor type selected, the water-ultrasonic combi sensor may include up to two different level measurements.

When using water-ultrasound or with hydrostatic level measurement, the types are equipped as follows:

- POA - one sound transducer
- CS2 wedge sensor - two different sizes of sound transducers
- CSM - no water-ultrasonic measurement

When measuring the level using water-ultrasound, the horizontal sound transducer utilise(s) the ultrasound time-of-flight (transit time) method. The measurement uses the time between transmission and reception of an impulse being reflected on the water surface.

$$h_1 = \frac{1}{2} \cdot (c \cdot t_1)$$

- with:
 - h = filling level
 - c = sound running time
 - t₁ = time between transmitted and received signal

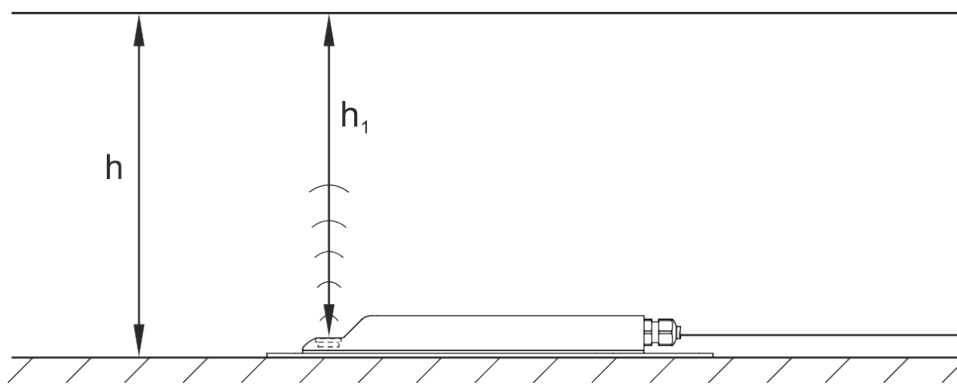

Fig. 20-7 Investigated filling level

At a medium temperature of 20 °C the sound running time in water is 1480 m/s.

The temperature-dependent deviation is 0.23 % per Kelvin.

To achieve level measurements with millimetre accuracy, the medium temperature is investigated permanently. The investigated temperature is used to correct the sound running time for calculation purposes.

The fixed level value is added to the determined value h_1 . The result is the total flow level h .

20.2.3 Pressure

POA, CS2 wedge sensors and the sensor CSM-D may be equipped with an extra hydrostatic level measurements.

The piezoresistive pressure sensor operates based on the relative pressure principle. The pressure of the static water column above the sensor is direct proportional to the filling level (depending on the density of the fluid).

Fluctuations in atmospheric pressure are compensated by a small air tube, which is integrated into the sensor cable. The pressure sensor allows to determine flow levels even if the sensor has been installed out of the centre of the channel bottom.

The pressure sensor is adjusted by entering a manually determined reference value at the initial start-up. Additionally, a height caused by the sensor installation is added.

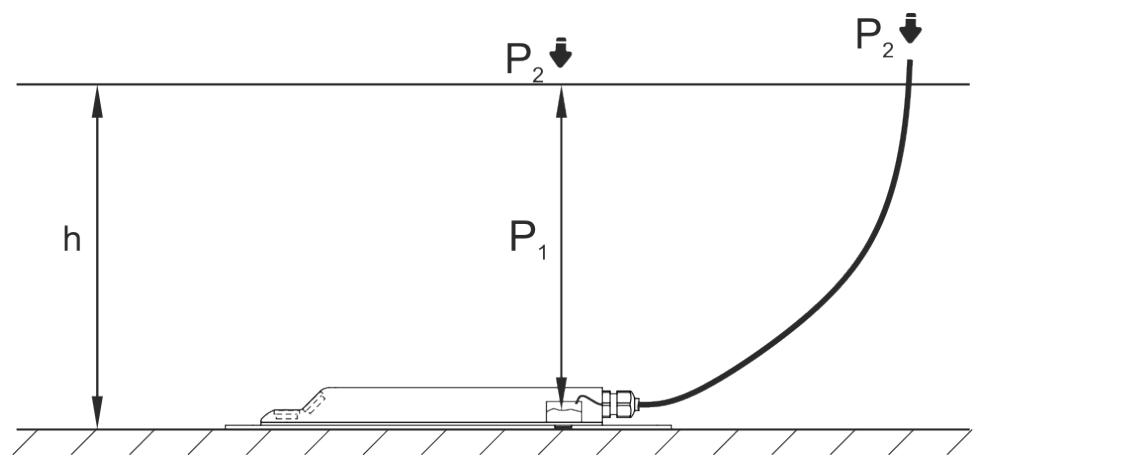

Fig. 20-8 Investigated filling level

Installation and Connection

21 General Installation Instructions

During the installation, ensure that the following instructions regarding ESD and installation place.

- Follow applicable legal or operational guidelines.

Improper handling can result in injury and/or damage to the equipment.

21.1 Hints on how to avoid electrostatic discharge (ESD)



ESD risks

Maintenance procedures which do not require power supply of the instrument shall not be executed before the unit has been disconnected from mains power in order to minimise danger and ESD risks.

Disconnect the NivuFlow from mains power.

The sensitive electronic components inside the unit may get damaged by static electricity. The manufacturer recommends the following steps to prevent the device from getting damaged due to electrostatic discharge:

- Discharge static electricity from your body before touching the instrument's electronic components.
- Avoid unnecessary movements to reduce the risk of building up static electricity.

21.2 Installation and Mounting versions

The transmitter is available in two different types of installation:

- E0 – for direct DIN rail mounting in control cabinets or similar enclosures
- E1 – special DIN rail mounting enclosure without cover stripe, with extended DIN rail fastening
 - Installation in NIVUS field enclosure *ZUB0 NFW0* or *ZUB0 NFW0 IP68*
 - iXT Ex separation module can be installed within field enclosure additionally



Pre-assembled units with simultaneous order

As soon as NivuFlow 750/700 (type of installation E1), Ex Separation Module and the field enclosure are ordered simultaneously the units are shipped in pre-assembled condition and are connected to each other via bus cable.

CAUTION



NivuFlow 750/700 type of installation E0 not suitable for installation in NIVUS field enclosure

*It is not possible to install a NivuFlow 750/700 type of installation E0 in a NIVUS field enclosure unless the transmitter is **converted** to a type of installation E1 unit. The conversion and the modification of connections can be carried out by NIVUS.*

Later installation in NIVUS field enclosure

If a converted installation type E0 transmitter (corresponds then to installation type E1) and an iXT Ex separation module are to be installed in a NIVUS field enclosure, connect transmitter and iXT according to Fig. 21-1 or Fig. 21-2.

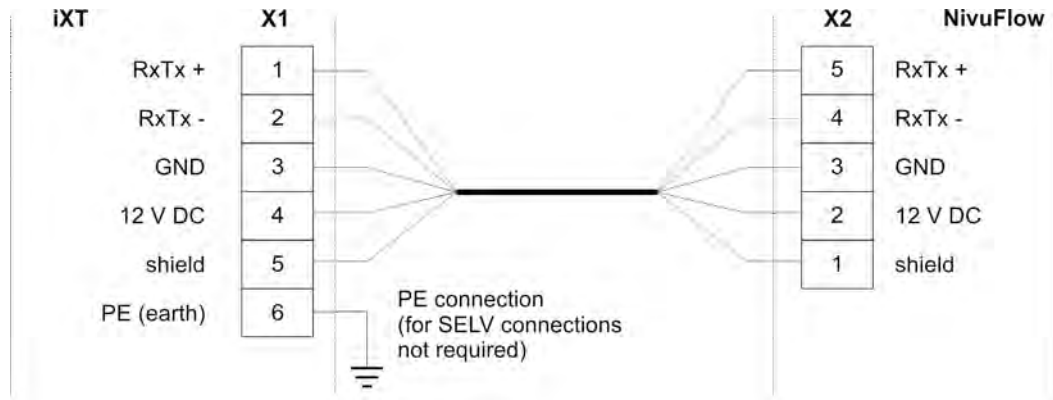

Fig. 21-1 Connection NF750/700 type S1 / SR

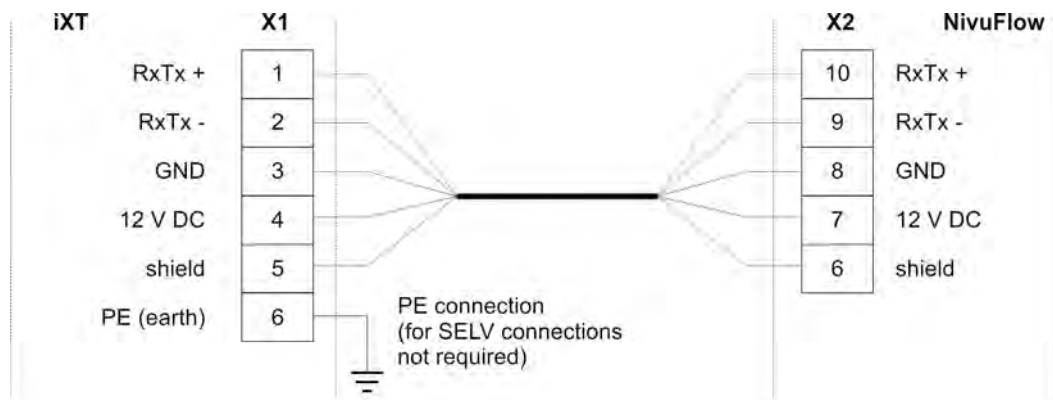

Fig. 21-2 Connection NF750 type M3

When installing transmitter and iXT into the field enclosure observe the correct installation position which is given by the separation element on the inside of the enclosure cover. The transmitter display shall be placed in the centre of the cover window. Minor adjustments are possible by moving the unit on the DIN rail accordingly. **For reasons of explosion protection, the connection cable (Fig. 21-3 Pos. 2) between iXT (Fig. 21-3 Pos. 4) and transmitter (Fig. 21-3 Pos. 3) must be laid above the separation (Fig. 21-3 Pos. 1) in the cover of the field enclosure (Fig. 21-3 Pos. 5).**



Fig. 21-3 Cable Routing in the Field Enclosure

21.3 Choosing the installation place

The NivuFlow with DIN rail fastening is conceived for installation in switching cabinets and mounting frames.

- Pay attention for adequate ventilation at the installation place, such as fans or air slits.
- During installation make sure that possibly existing separating devices (power switch) remain to be easily accessible.

It can be also installed in field enclosures or similar. Due to the protection degree, NivuFlow is not suitable to be installed directly on site without protective measures. To do so, use the optionally available field enclosure by NIVUS.

For safe installation on the mounting place make sure to take the following precautions:

- Protect the transmitter from direct sunlight. Install a sun shading if required.
- Avoid mounting the transmitter close to objects with strong electromagnetic fields (frequency converters, high voltage powerlines or similar).
- Observe the permissible ambient temperature (see chapter "17 Specifications").
- Do not expose the transmitter to strong vibrations or mechanical shocks.

At the mounting place always avoid:

- Corrosive chemicals or gases
- Radioactive radiation
- Direct installation close to footpaths or travel ways

21.4 Transmitter fastening on DIN rail in control cabinets



Note

Mounting materials and tools are no part of the standard delivery.

- For fastening use a DIN rail type TS35 according to EN50022 with a minimum length of 140 mm.

1. Fasten the rail horizontally in the intended enclosure/switching cabinet by using at least two screws.
2. Hook the transmitter into the DIN rail from below. The unit will snap in as soon as you exert slight pressure in the direction of the DIN rail.

Now you can begin to install the electric components and to connect the sensors.

21.5 Field enclosure fastening and preparing electric installation



Note

*The fastening material is **not** part of the standard delivery but must be defined and chosen individually depending on the place of installation.*

The NIVUS field enclosure can be installed permanently once the appropriate place of installation has been chosen. A basic condition is safe, durable and stable installation.

Required materials and auxiliary tools

- 6x screws M5, M6 or other screws sufficient for 6.5 mm diameter for proper fastening on surfaces (type and lengths of screws depending on material and quality of the surface)

- 6x dowels may be required (depending on material and quality of the surface as well as the screws used)

Preliminaries

➡ Procedure:

1. Select fastening screws (type and length of screw) and accessories considering:
 - conditions and load capacity of the mounting surface (wood, metal, concrete, brickwork or similar)
 - required dowels or other auxiliary material

Tip:

When determining the length of the screws necessarily include the material thickness (approx. 17 mm) of the mounting brackets.

2. If required drill dowel holes and insert the dowels.

Fastening the field enclosure

➡ Procedure:

1. Fasten the field enclosure (Fig. 21-4 no 3) on both lateral brackets by using the six previously selected screws through the fastening holes (6.5 mm diameter, Fig. 21-4 no 6).

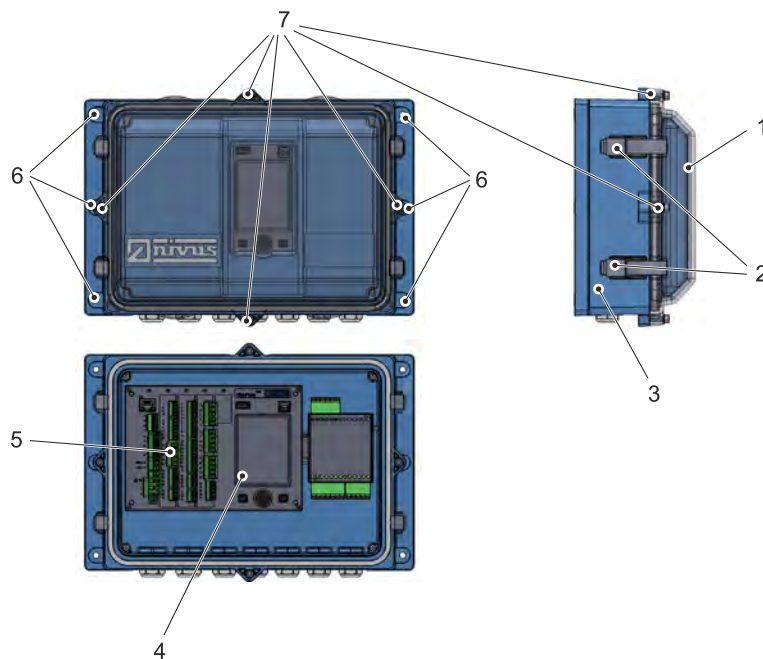

Fig. 21-4 Fastening the field enclosure

2. Remove the transport protection film from the clear view cover (Fig. 21-4 no 1) if available.

Tip:

The protective film will harden upon exposure to UV radiation and possibly cannot be removed later without leaving any residue. Due to the changes to the protective film the readability may be strongly impaired.

New clear view covers can be purchased from NIVUS at extra costs and can be easily replaced by the user.

3. Install the weatherproof cover if available.

Preparing the field enclosure for electric installation

➡ Procedure:

1. To remove the clear view cover (Fig. 21-4 no 1) from
 - enclosure type *ZUBO NFW0* (protection IP67):
Open the four lateral release clamps (Fig. 21-4 no 2) and remove the enclosure cover.
 - enclosure type *ZUBO NFW0 IP68* (protection IP68):
Remove the four cylinder head screws M4x25 (Fig. 21-4 no 7) including the washers, open the four lateral release clamps (Fig. 21-4 no 2) and remove the enclosure cover.
2. To remove the blue inside cover loosen the four round head screws M3.5x25 in the corners and remove the cover. Now the transmitter including the display (Fig. 21-4 no 4) and the terminal clamps (Fig. 21-4 no 5) as well as the iXT are freely accessible.
3. Reassembly after electric connection is carried out in a reversed order. Here necessarily observe that
 - the gaskets are undamaged and free of dirt
 - the screws are tightened firmly
 Otherwise the IP67/IP68 protection rating **cannot be guaranteed**.

22 Electric Installation

DANGER



Danger from electrical current

Disconnect the unit from mains power.

Working on electric connections may cause the risk of electric shocks. Observe electric information provided on the nameplate.

Non-observance may result in personal injuries.



Note

Observe the national installation regulations.

➡ Make sure to take the following precautions:

1. Observe that the installation shall be carried out by qualified personnel only.
2. For electric installation the local regulations in the respective countries (in Germany e.g. VDE 0100) shall be referred to.
3. Further statutory standards (local), regulations and technical rulings have to be taken into account.
4. For installation in wet environments or in areas subject to flooding risk, extra protection such as by using a residual-current-operated protective device (RCD) is necessary if required.
5. Regarding Ex protection check whether the instruments power supply needs to be integrated into the facility's emergency shut-down concept.
6. Before feeding the rated voltage, transmitter and sensor installation must be correctly completed. Check that the installation is correct.



How to connect the sensors can be found starting at page 45, connecting the power supply is described on page 43.

22.1 Connection to the Terminal Blocks

All NivuFlow transmitters are equipped with push-in tension clamp terminals. The use of these push-in tension clamp terminals enables an easy pre-installation of the transmitter.

This allows verifying individual sensors, input and output signals etc. as well as easy transmitter replacement if required.

The tension clamp terminal blocks are suitable for the connection of single-wire and multiple wire copper cables. These cables are vibration-proof.

- ➡ To open the contacts on the tension clamp terminal blocks, use gentle pressure with a slot screwdriver on the front-side orange elements.

To connect the power supply push-in and screw-type tension clamp terminal blocks are used. To connect the power supply, use a slot screwdriver with a blade width of 3.0...3.5 mm.



Important note

Unplug and connect the tension clamp terminal blocks only in de-energised condition disconnected from mains power.

DANGER



Danger from electrical current

Multiple wire cables (strands) of the AC power supply circuit as well as of relay connections shall be equipped with ferrules featuring an isolated protective collar (plastic ferrule) to avoid danger due to several protruding wires.

Non-observance may result in personal injuries.

Tension clamp terminal block	Power supply	Bus/ Network	Terminals O/I etc.	Air ultrasonic sensor OCL-L1
Wire cross section, rigid cables in [mm ²]	0.2...2.5	0.2...0.5	0.14...1.5	0.2...2.5
Wire cross section, flexible cable in [mm ²]	Only DC: 0.2...2.5	0.2...0.5	0.14...1.5	0.2...2.5
Wire cross section (flexible) with ferrule blank in [mm ²]	Only DC: 0.25...2.5	0.25...0.5	0.25...1.5	0.25...2.5
Wire cross section (flexible) with ferrule with plastic sleeve in [mm ²]	0.25...2.5	Undefined	0.25...0.5	0.25...2.5

Table 22-1 Wire cross sections

The measurement transmitter **NivuFlow 750** is available in four different **versions**:

- Type S1 - standard version each for one flow velocity sensor, one level sensor and the option to additionally connect an external level sensor
- Type SR - standard version with extra controller function
- Type M3 - extended connection options for up to three flow velocity sensors
- Type M9 - options to connect up to nine sensors via iXT or MPX. Suitable for very wide channels or for up to three different measurement places in physical proximity.

All four versions have the some clamp designations. These blocks are functionally assigned to the different connection areas. The transmitter types SR, M3 and M9 have additional terminal blocks.

The measurement transmitter **NivuFlow 700** is available in one **version**:

- Type S1 - standard version each for one flow velocity sensor, installed in full channels or pipelines

22.2 Plans of terminal connections

DANGER



Risk of electric shock

Do not remove the tension clamp terminal block from board X1 (connections 15...17).

This tension clamp terminal block is to connect the protective conductor as well as the AC power supply and is an integral part of the instrument. Operate the instrument with the tension clamp terminal block screwed on only.

Non-observance may result in personal injuries.

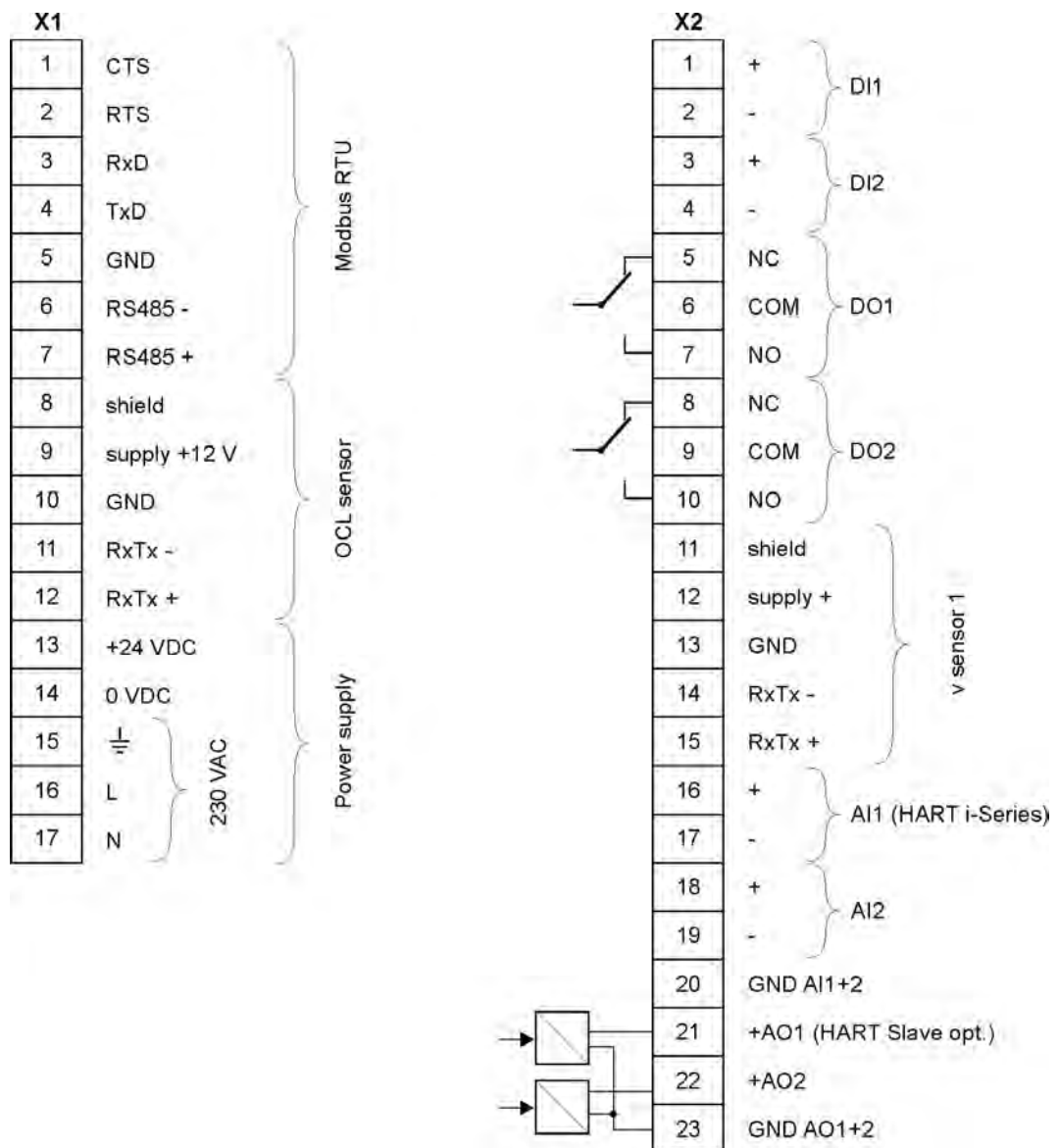

Fig. 22-2 Terminal connections NivuFlow 750/700 type S1

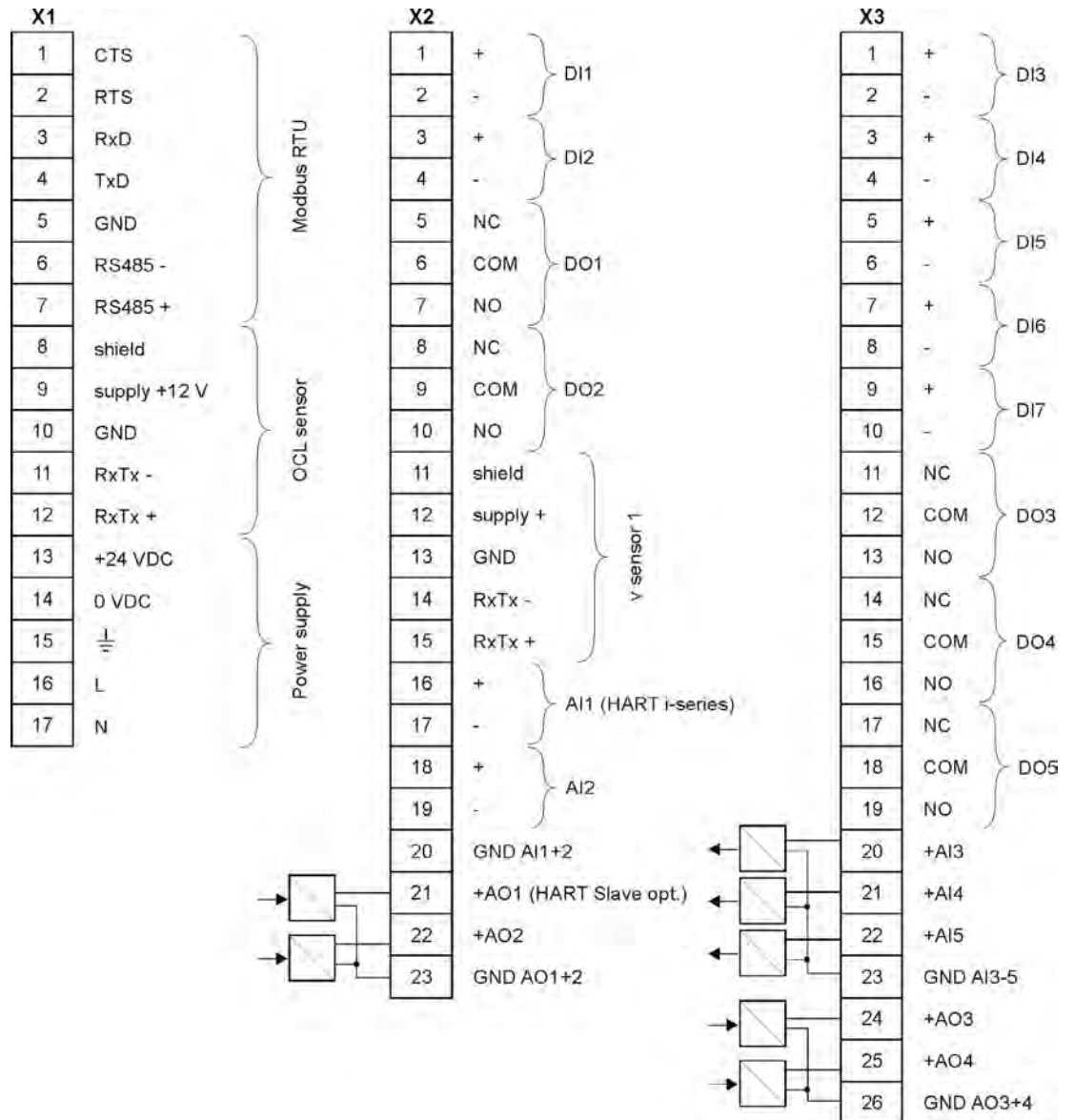

Fig. 22-3 Terminal connections NivuFlow 750 type SR

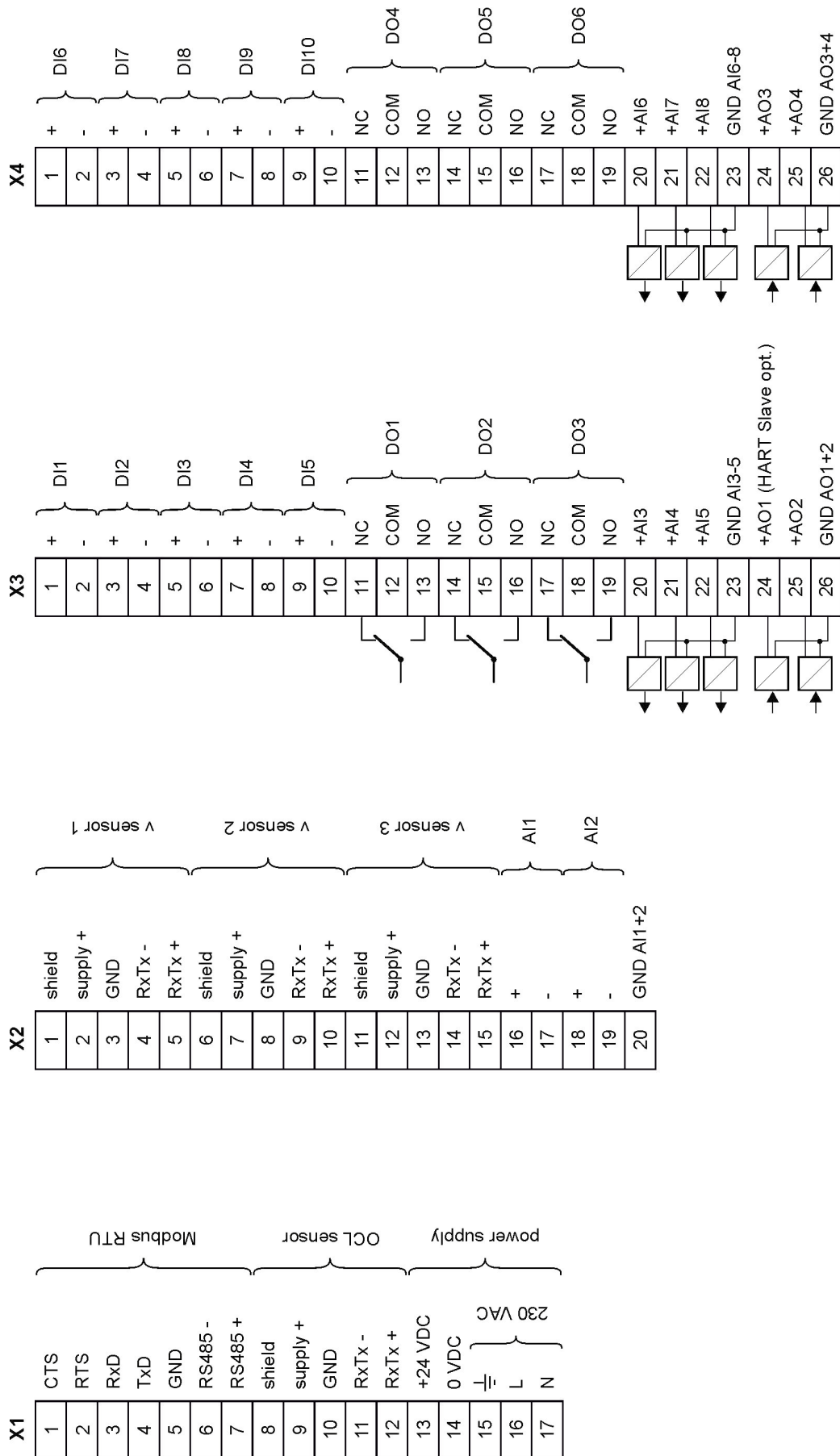

Fig. 22-4 Terminal connections NivuFlow 750 type M3 / M9

22.3 Switching on voltage supply

Depending on the type of NivuFlow used the unit can be powered with 100...240 V AC (-15 / +10 %) or with 10...35 V DC.

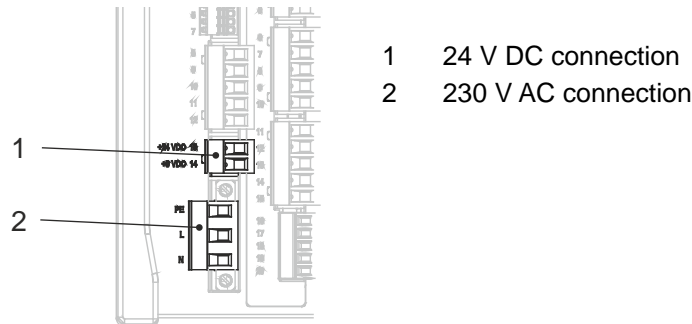

Fig. 22-5 Electrical Connections of power supply NivuFlow

DANGER



Risk of electric shock

Do not remove the tension clamp terminal block from board X1 (connections 15...17).

This tension clamp terminal block is to connect the protective conductor as well as the AC power supply and is an integral part of the instrument. Operate the instrument with the tension clamp terminal block screwed on only.

Non-observance may result in personal injuries.



Operation with alternating current - direct current

A transmitter with 24 V **DC** cannot be operated with **alternating current**. Further, it is **not** possible to operate a 230 V **AC** transmitter with 24 V **direct current**.

22.3.1 Power supply DC

The DC version can be directly operated from the 24 V direct current network of a control cabinet.

Requirements

- Input voltage available at the input clamps:
 - At maximum load (20 W) minimum 10 V
- Clamp voltage:
 - At no-load operation maximum 35 V

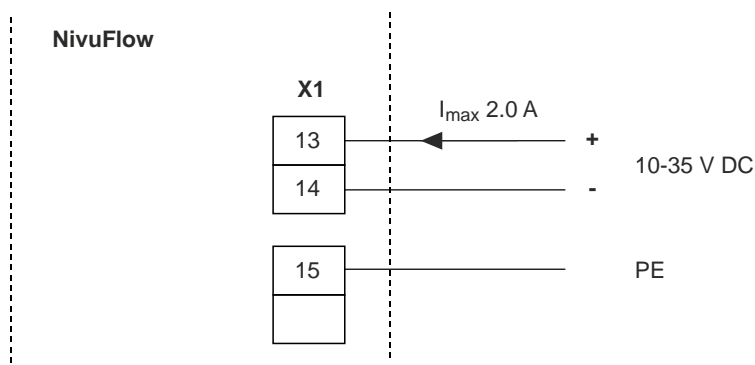

Fig. 22-6 DC connections of power supply

22.3.2 Power supply AC

DANGER



Danger from electrical current

Do not operate the unit if the terminal clamp blocks above the screw flange are not tightly screwed.

The terminal block X1 (connections 15...17) for connection of the earth conductor and AC power supply is an integral part of the device. It is no plug connection.

Non-observance may result in personal injuries.

DANGER



Danger from electrical current

The power supply must be separately protected by a 6 A slow-blow fuse and has to be isolated from other facility parts separate turn-off, e.g. by using an automatic cut-out with >B< characteristics). This separator should be marked conveniently.

Non-observance may result in personal injuries.

The AC version of NivuFlow can be directly operated from the low-voltage network.

➡ The AC power supply requirements are described in chapter “17 Specifications”.

Requirements

- Cross-sectional dimension of the power supply wires:
 - Minimum 0.75 mm²
 - According to IEC 227 or IEC 245

The AC version of the NivuFlow provides an auxiliary voltage of 24 V with a maximum load capacity of 80 mA at the terminals of the DC connection. This auxiliary voltage can be used, for example, in devices with integrated controller function for the necessary connection of the contacts of the slider end positions or the torque switch to the digital inputs of the NivuFlow.

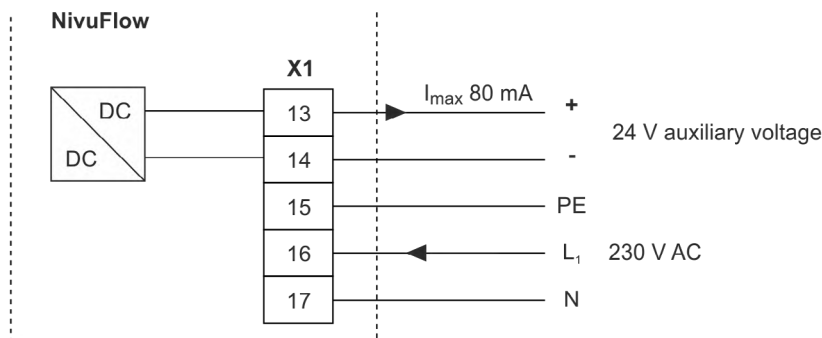

Fig. 22-7 AC connections of power supply

22.4 Relays

The reliability of the switching contact deteriorates if the minimum switching current is lower than specified.

⇒ Observe the connection and switching specifications of the relays in chapter “17 Specifications”.

DANGER



Danger from electrical current – Measures to prevent accidental contacts

Contact protection according to the requirements as specified in EN 61010-1:2010 is not guaranteed in the event of relay voltages >150 V due to the testing pin terminal of the relay clamp blocks.

Take all necessary protection against electrical shock according to the laws and regulations.

For example: Open the cabinet/field enclosure only by the use of a tool or key, or use fault-current circuit breaker or similar.

Non-observance may result in personal injuries.

DANGER



Danger from electrical current – Protect Relay Contacts

The relay contacts of the instrument shall be protected using 6 A slow-blow fuses as soon as voltages in the low voltage range (such as AC supply voltages) are to be switched via the instrument's relay contacts. Moreover these contacts shall be designed so as to be switched off independent from other circuit parts.

DC units shall be equipped with an appropriate protective earth conductor in order to avoid dangerous voltages or currents.

Non-observance may result in personal injuries.

23 Installation and connections of sensors

The installation of individual sensor types is described in greater detail in the according installation instructions.



Note

During mounting works ensure compliance with all regulations on safety at work.

23.1 Sensor Installation Principles

The placing of sensors is vital for the reliability and accuracy of measurement results. Therefore observe proper hydraulic conditions and appropriate calming sections on the place of installation. Sensor types as well as the respective fastening methods shall be determined individually depending on the measurement place.



Conditions on how to select calming sections and the installation of sensors are described in the according installation instruction.

23.2 Cable and cable lengths for sensor connection

Between sensor and transmitter (direct connection non Ex):

For the complete distance between the NIVUS sensors and transmitter type NivuFlow use the specified cable of NIVUS:

- LiYC11Y 2x1.5 mm² + 1x2x0.34 mm² + PA

PA means the pressure compensation hose in the sensor cable.

The signal cable is not suitable for direct and permanent installation in ground. Use sufficient protective tubes or protective hoses with appropriate inner diameters if the signal cable is to be installed in ground, concrete or similar.

Between sensor and iXT:

Maximum cable lengths between sensors and iXT if using the NIVUS standard cable LiYC11Y 2x1.5 mm² + 1x2x0.34 mm² + PA:

- 150 metres
- Use of overvoltage protection elements
 - Single-side: 135 metres
 - Double-side: 120 metres



See chapter “26 Overvoltage Protection”.

PA means the pressure compensation hose in the sensor cable.

Between iXT/MPX and transmitter (standard cable):

Maximum cable lengths between transmitter and iXT/MPX if using the NIVUS standard cable LiYC11Y 2x1.5 mm² + 1x2x0.34 mm²:

- iXT - 100 metres
MPX - 100 metres
- Use of overvoltage protection elements:
 - No influence

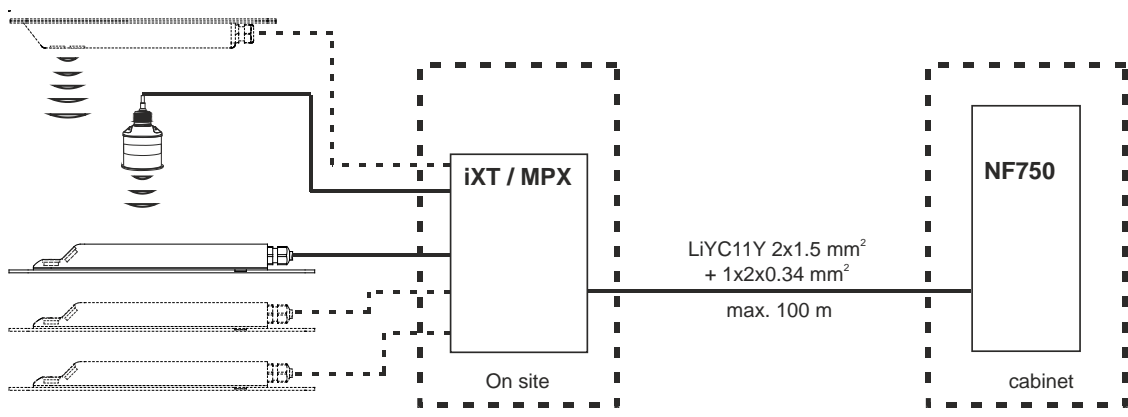

Fig. 23-1 Connecting iXT/MPX to NivuFlow via standard cable

Between iXT/MPX and transmitter (telecommunications cable)

Maximum cable lengths between iXT/MPX and transmitter if using a type A2Y(L)2Y 10x2x0.8 telephone cable:

- iXT - 300 metres
MPX - 300 metres

To do so, nine wires for power supply and GND each are combined. One wire pair is used for RS485 communication.

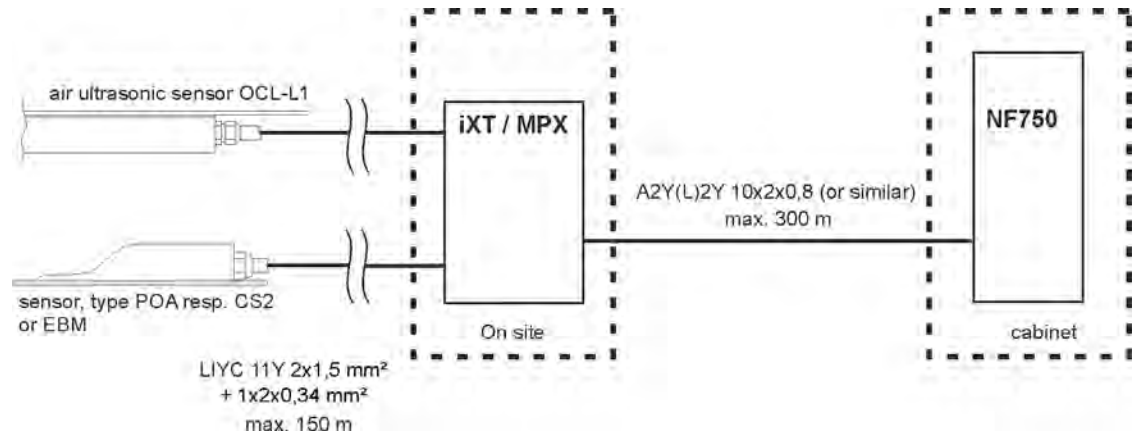

Fig. 23-2 Connecting iXT/MPX to NivuFlow via telecommunications cable

23.3 Connection of iXT and MPX

Intelligent Ex Separator Module iXT

The iXT serves as Ex separation module for Zone 1 between the sensors (Type POA-V2, CS2, EBM Electronic Box, OCL air ultrasonic sensor, i-Sensor and the NivuBar Plus series) and the NivuFlow transmitter.

The sensors here necessarily need to be approved for use in Ex zones 1 or 0:

- Zone 1:
POA-V2, CS2, Electronic Box EBM, OCL air ultrasonic sensor and NivuBar Plus series
- Zone 0:
i-Sensor



Hints on i-Sensor

The i-Sensor **Zone 1** is encapsulated and is connected **directly** to the NivuFlow.

The i-Sensor **Zone 0** is intrinsically safe and shall be connected **only** to the iXT Ex separation module.

The **fuse** at the cable end of the Ex zone 1 sensor is Ex-relevant and must **not** be removed.



Ex Approval and EC Type Examination Certificate

The Ex approval is only valid in connection with the respective indication on the iXT enclosure nameplate.

The iXT Ex version is matched to the NIVUS sensors regarding the assessment of intrinsically safe electrical systems according to EN 60079-25.

The required specifications for the Ex versions of the sensors can be taken from the EC Type Examination Certificates TÜV 03 ATEX 2262 or TÜV 12 ATEX 087812.

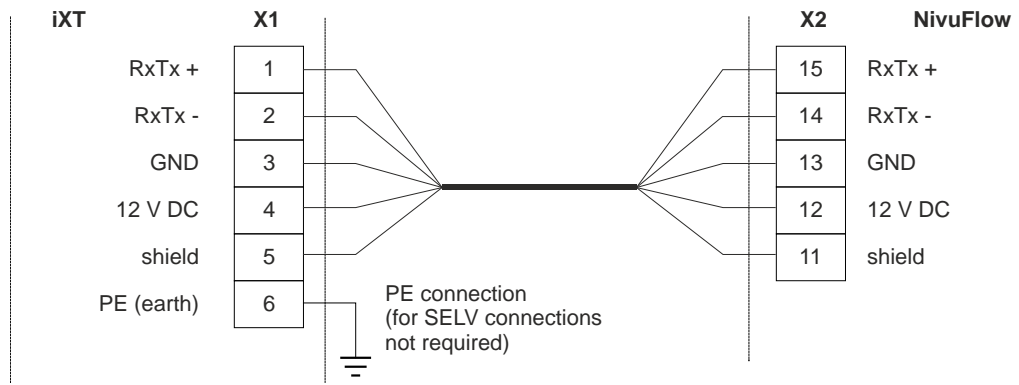

Fig. 23-3 iXT to NF750/700 type S1 / SR

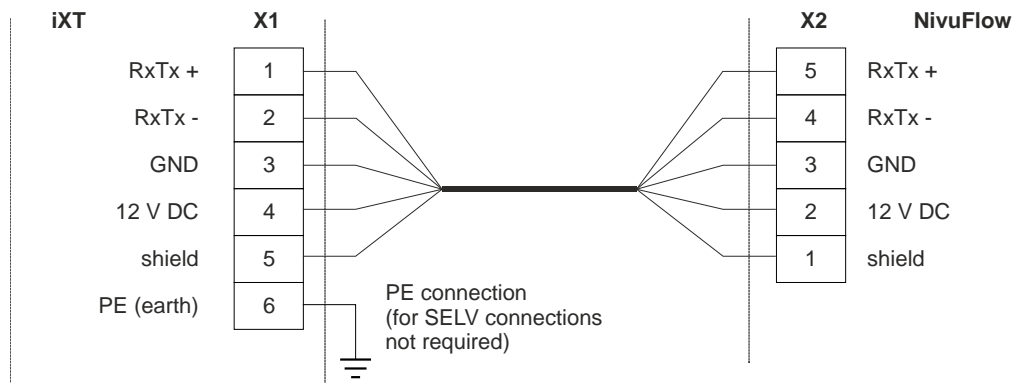

Fig. 23-4 iXT to NF750 type M3 resp. 1st iXT to NF750 type M9

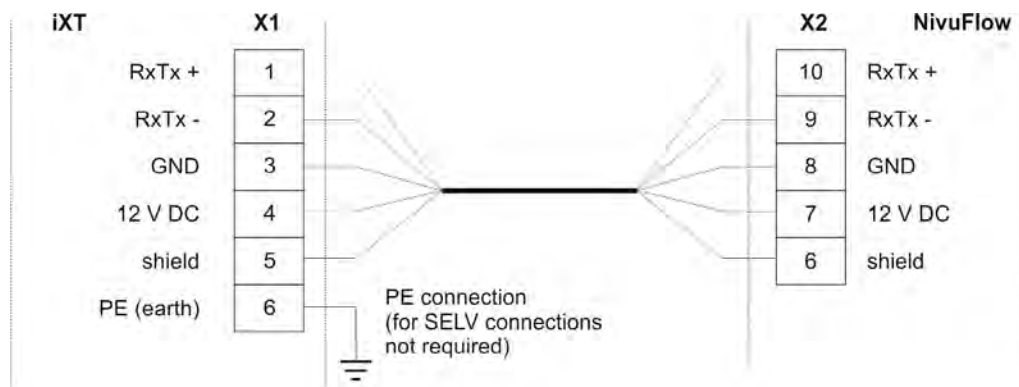

Fig. 23-5 2nd iXT to NF750 type M9

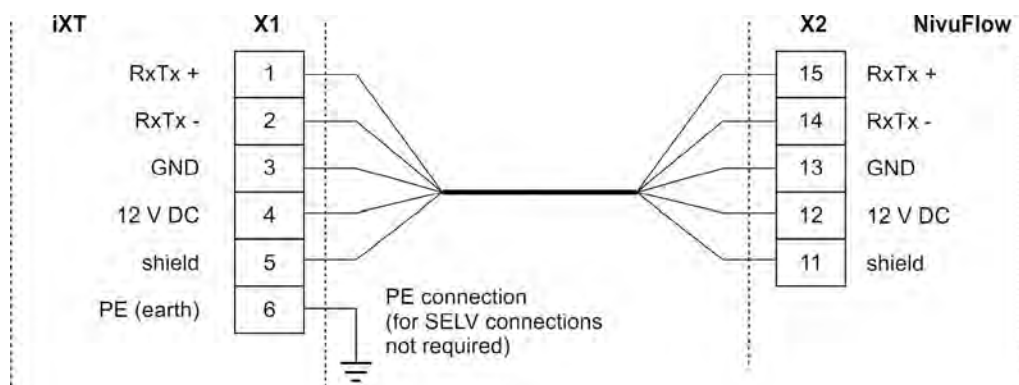

Fig. 23-6 3rd iXT to NF750 type M9



More detailed information on iXT, connection of varying sensors to iXT, over-voltage protection measures etc. can be found in the "Technical Description for iXT0 Ex Separation Module".

Multiplexer MPX

The Multiplexer MPX is an intelligent electronic module between one or more flow velocity and level sensors on site or in proximity of the sensors. It combines all sensor signals transmitting them to the NivuFlow transmitter through one single cable.

In combination with an auxiliary relay and an external power supply on site the MPX serves as line driver. By using an appropriate cable it is possible to achieve a distance of up to 1000 m between MPX and NivuFlow.

Sensors which can be connected to iXT can be connected to the MPX likewise.

Ex approvals are not required here.

Moreover it is possible to apply a 4...20 mA level signal from an external transmitter.

By using one NivuFlow 750 type M9 transmitter and more than one MPX it is possible to connect up to nine flow velocity sensors simultaneously and to configure up to three measurement places (provided the transmitter is equipped with this function; see also Table 18-1 on page 27).

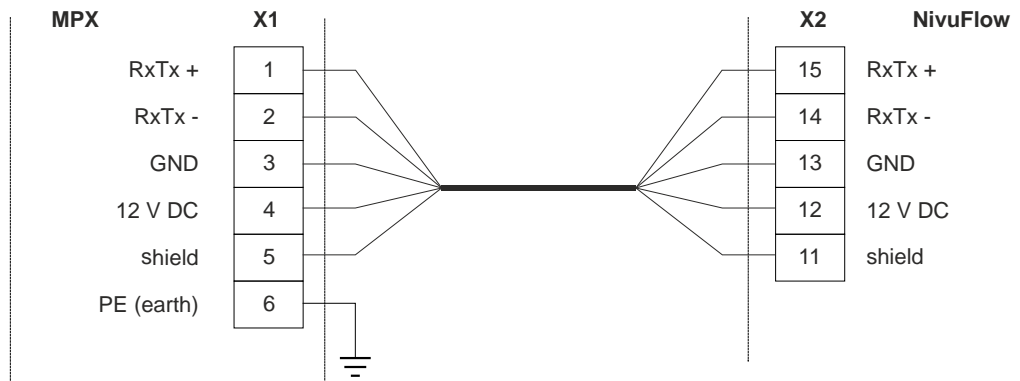

Fig. 23-7 MPX to NF750/700 type S1 / SR

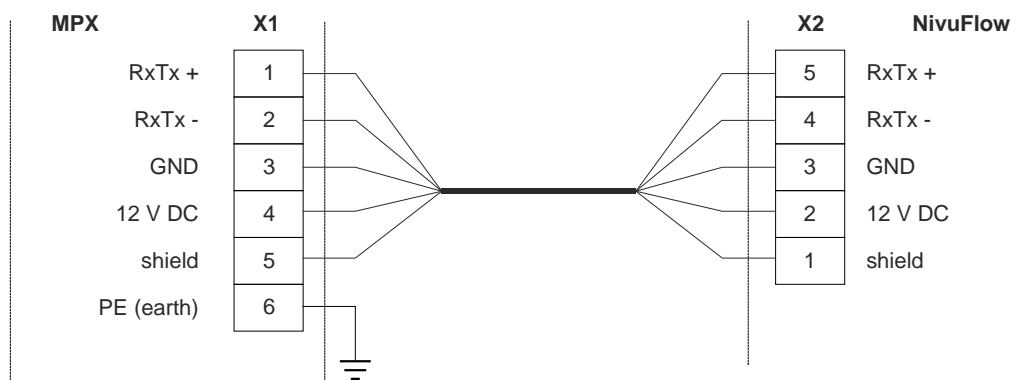

Fig. 23-8 1st MPX to NF750 type M3 / M9

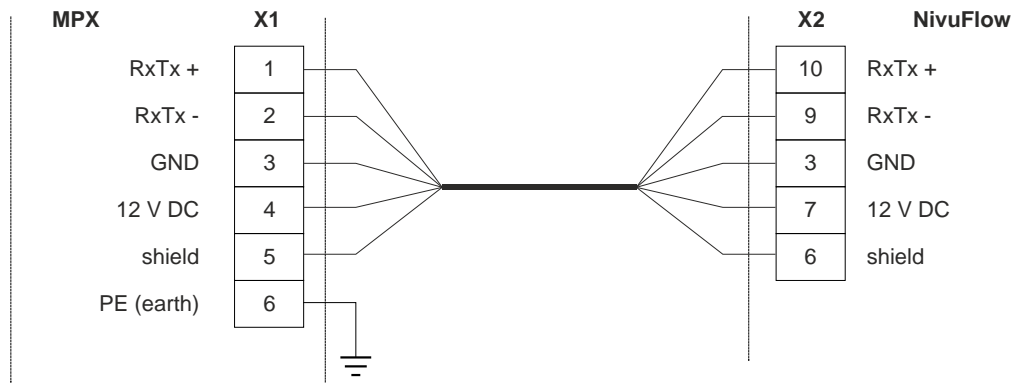

Fig. 23-9 2nd MPX to NF750 type M9

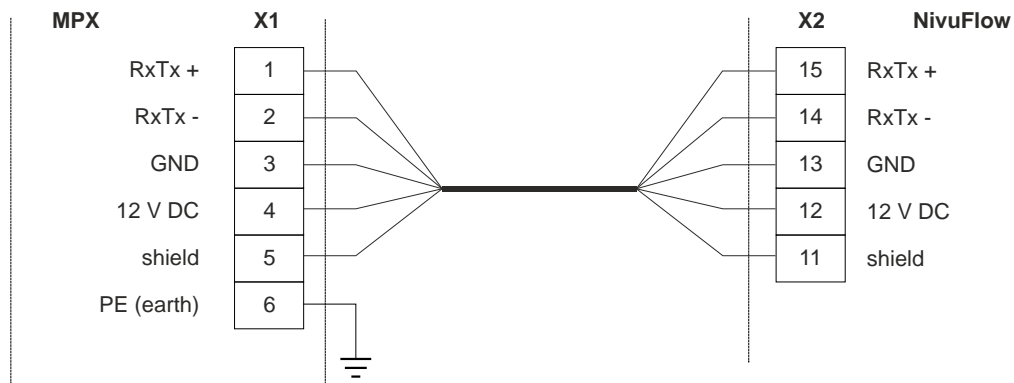

Fig. 23-10 3rd MPX to NF750 type M9



More detailed information on MPX, connection of varying sensors to MPX, overvoltage protection measures etc. can be found in the "Technical Description for MPX Multiplexer".

23.4 Sensor Connection at NivuFlow

The connected sensors are used to

- Determine the flow velocity:
 - Using the connected flow velocity sensors
- Detection/determination of the filling level:
 - Using the connected level and/or combi sensors
 - Via Modbus
 - By defining a fixed value

23.4.1 Connecting flow velocity sensors

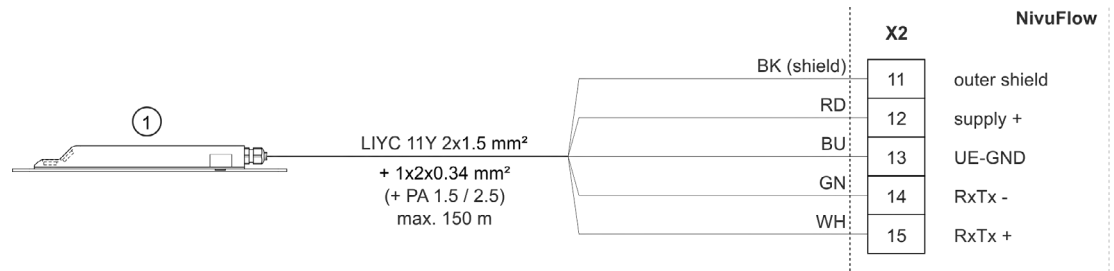

- 1 Connectable flow velocity sensors (POA-V200/V2H1/V2D0, CS2-V100/V200/V2H1/V2D0/V2U1, CSM/CSM-D/DSM via Electronic Box EBM)

Fig. 23-11 Connection of flow velocity sensor to NF750/700 type S1 / SR

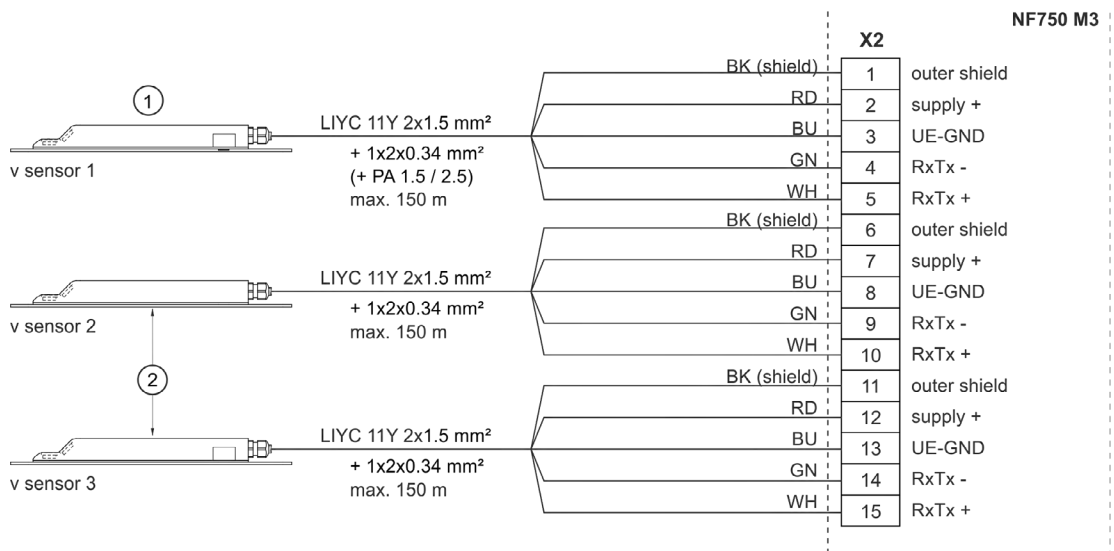

- 1 Sensor 1 (leading sensor) or Electronic Box
- 2 Sensor 2/3 (additional flow velocity sensor) or Electronic Box

Fig. 23-12 Connection of flow velocity sensors 2/3 to NF750 type M3

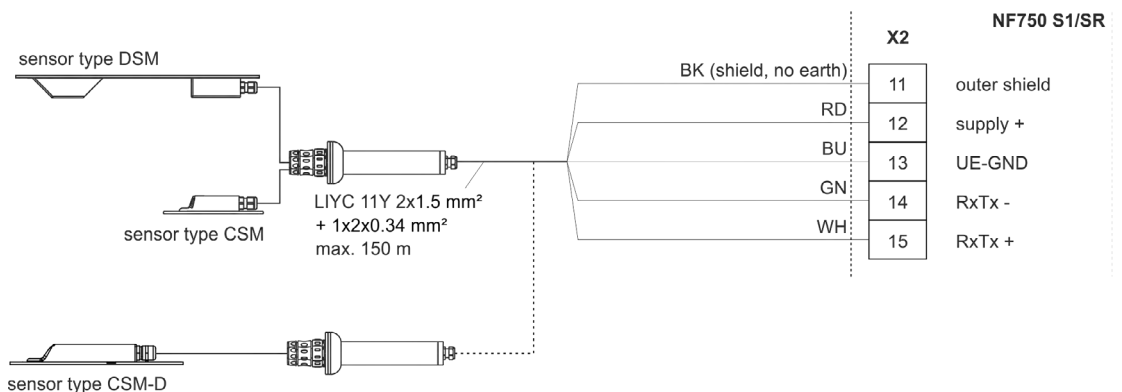

Fig. 23-13 Connection of sensor family Mini to NF750/700 type S1 / SR

- Connection of a **CSM-D** sensor:
Exactly the same as the CSM/DSM sensor.
- Connection of two or three **electronic boxes** to a NivuFlow 750 type M3:
Exactly the same as the direct connection of the flow velocity sensors in Fig. 23-12.

- Connecting an **Electronic Box** to a NivuFlow 750 Type M3 together with a **DSM** sensor:
Electronic Box must always be connected as guide sensor (v-sensor 1).
- Flow velocity sensor with **integrated pressure measurement cell** to a NivuFlow 750 type M3:
 - find more detailed information on sensor installation in the “Installation Instructions for Correlation and Doppler Sensors”.
 - connect the sensor with integrated pressure measurement cell to the terminal for v-sensor 1 (lead sensor).
 - use **only one** sensor with integrated pressure measurement cell.
 - a pressure compensation element **must** be used when a pressure measurement cell is built in.



Hints on Pressure Compensation Element

The pressure compensation element serves as connection socket for cable extension at the same time.

Observe not to exceed the maximum cable length between sensor and transmitter of 150 m in Ex areas in consideration of the maximum permissible line resistance.

23.4.2 Connection of level sensors

Air ultrasonic sensor

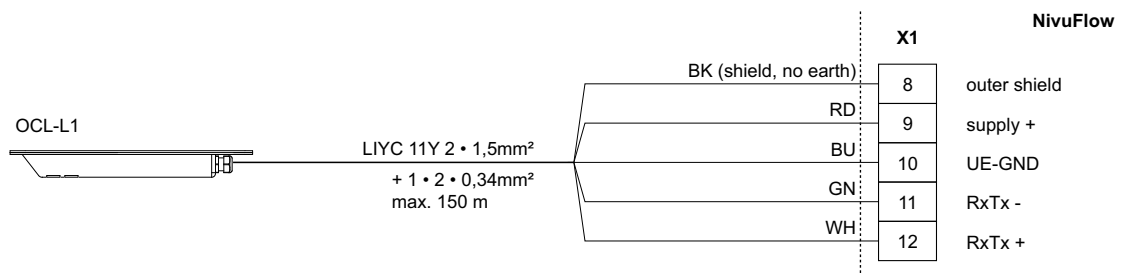

Fig. 23-14 Connection of air ultrasonic sensor type OCL-L1

2-wire sensor

The level measurement can (as an alternative to an integrated pressure cell) also be carried out by a 2-wire sensor (e.g. i-sensor, NivuBar Plus) which is supplied by the NivuFlow.

- ➡ Connect the 2-wire sensor according to Fig. 23-15.



Fig. 23-15 Connection of 2-wire sensor for level measurement

- ➡ If the mA signal of the level measurement is provided from an external transmitter (e.g. NivuMaster), the transmitter must be connected according to Fig. 23-16.

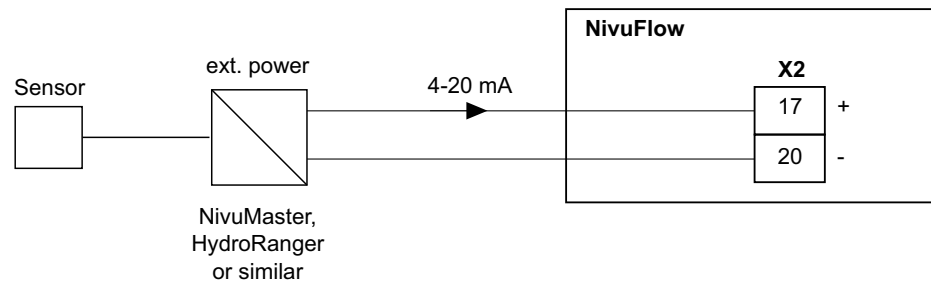

Fig. 23-16 Connection of an external level measurement

23.4.3 Special Points for Sensor Connection in Ex-Area Zone 1

- OCL-Sensor:
Connection only to iXT Ex Separation module
- 4...20 mA signals from external transmitters:
connection to NivuFlow
- i-sensors with Ex approval:
 - Zone 1:
only direct connection to NivuFlow, not to iXT Ex Separation module
 - Zone 0:
connection only to iXT Ex Separation module, not to NivuFlow

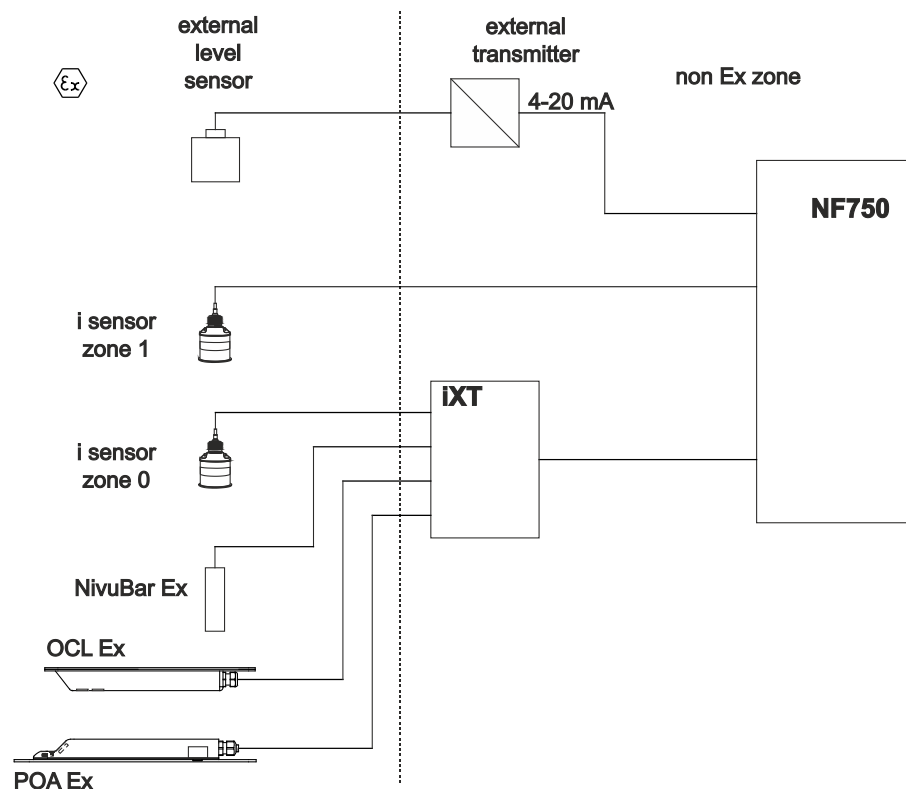

Fig. 23-17 Special points for connection in Ex zone 1

24 Controller operation

24.1 General



Important note

In order to correctly and reliably set the controller functions it is necessarily required to have general and basic knowledge on control technology as well as on parameters and adjustment procedures commonly used in control technology available.

To implement flow rate control a NivuFlow 750 transmitter Type SR, M3 or M9 is required. The S1 standard transmitter type is **not** sufficient for this purpose since it is not equipped with the number of inputs and outputs required for slide valve control and the internal flow control software is not available.

If Type S1 is to be used for flow rate control anyway it is necessary to use an additional external controller which then needs to be configured according to the manufacturer's specifications.



Important note

Only one control setup can be assembled using a NF750 Type M9.

*This control setup is **permanently assigned** to measurement place 1 and cannot be assigned to the (optionally available) measurement places 2/3.*

Connecting inputs and outputs to slide valve controls



Note on Assignment

*The assignment of the inputs and outputs to the controller as well as the analogue input for a possible external control setpoint of the transmitter are **fixed** and cannot be changed.*

	Type SR	Type M3/M9
DI Slider Way CLOSED	DI4	DI7
DI Slider Way OPEN	DI5	DI8
DI Slider Torque CLOSED	DI6	DI9
DI Slider Manual	DI7	DI10
DO Slider Way CLOSED	DO4	DO4
DO Slider Way OPEN	DO5	DO5
AI Control Setpoint	AI5	AI5

Instead of the fixed internal setpoint, an external setpoint that can be changed from outside can be used.

This external set point is routed to analog input 5 as 4...20 mA input signal and permits to remotely control discharge volumes or automatic tank management by using appropriate remote control equipment featuring 4...20 mA output signals.

Furthermore it is possible to connect an external signal (e.g. via a key switch) to a digital input of the transmitter to switch the transmitter's controller functions to OFF (MANUAL operation) for maintenance and repair works.

Use a slide gate valve or a wedge gate valve with electric gate control and 3-step control as actuator.

Slide valves with analog control input cannot be controlled.

NIVUS recommend using the **control times** below (run time between slide valve fully open to fully closed):

- ≤ DN300: min. 60 seconds
- ≤ DN500: min. 120 seconds
- ≤ DN800: min. 240 seconds
- ≤ DN1000: min. 300 seconds

Depending on the application even other settings may be required.

For correct **control** and **error monitoring** of the slide valve it is essential to provide end-of-way switch >OPEN< and >CLOSED< as well as torque switch >CLOSED< signals. These signals must be available on the transmitter's digital inputs.

If possible, make sure to have gold-plated contacts available on the input signal contacts to ensure reliable switching.

A signal relay must be interconnected if standard contacts are used. The signal relay contacts shall be designed so as to ensure reliable forwarding of the 10 mA input current to the digital input of the transmitter.

Feeding an analogue slide valve position message back to the transmitter is not supported.

The transmitter operates as 3-step controller with surge detection, quick-close function and slide valve monitoring.

The digital outputs 4 and 5 are pre-determined for actuator control:

- DO4: >Close slide valve<
- DO5: >Open slide valve<

Analog input AI 5 is pre-determined for the input of an external setpoint.



Note

Inputs and outputs are permanently assigned to the controller. These settings cannot be changed.

The input current on the transmitter's digital inputs is 10 mA. Reliable end switch contact shall be made sure by choosing appropriate contact materials on the end switch of the slide valve.

24.2 Control Section Setup



A detailed description of the installation of measurement and control sections including the required calming sections and dome heights can be found in the "Installation Instructions for Cross Correlation and Doppler Sensors".

Use this information in addition.

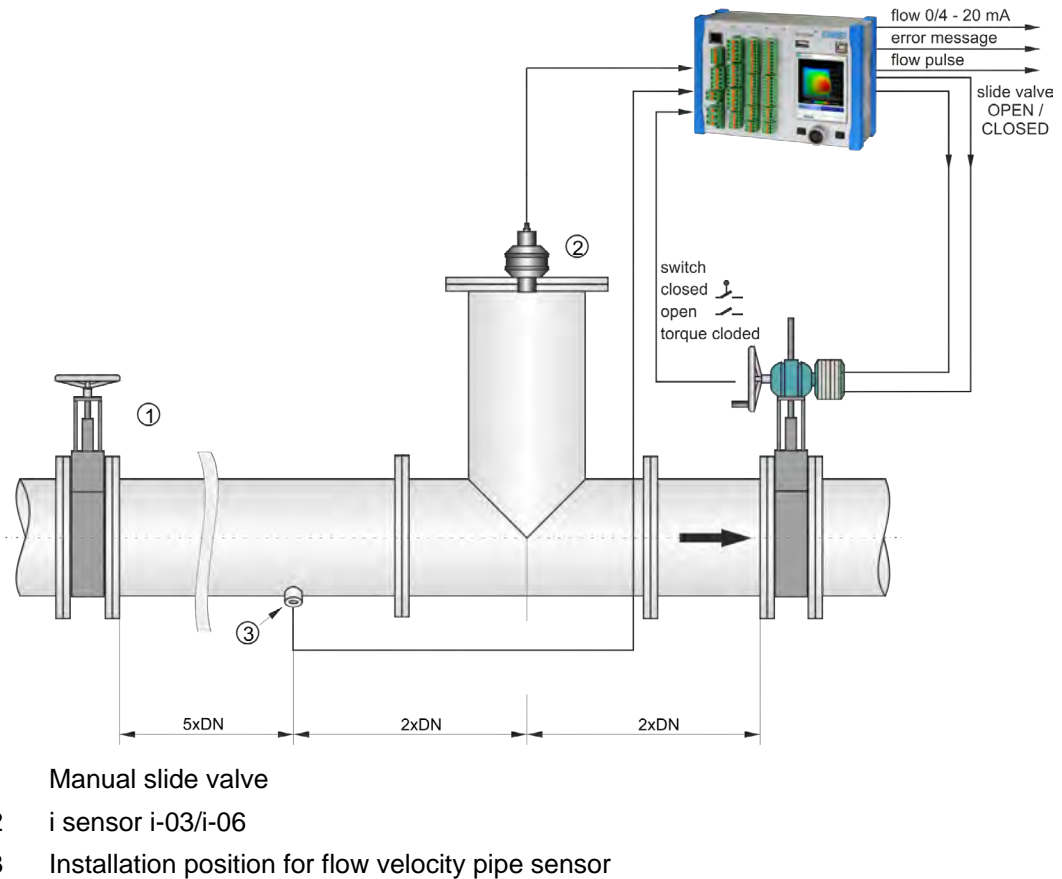

Fig. 24-1 Control section setup based on discharge control

24.3 Wiring Diagrams for Control Operation

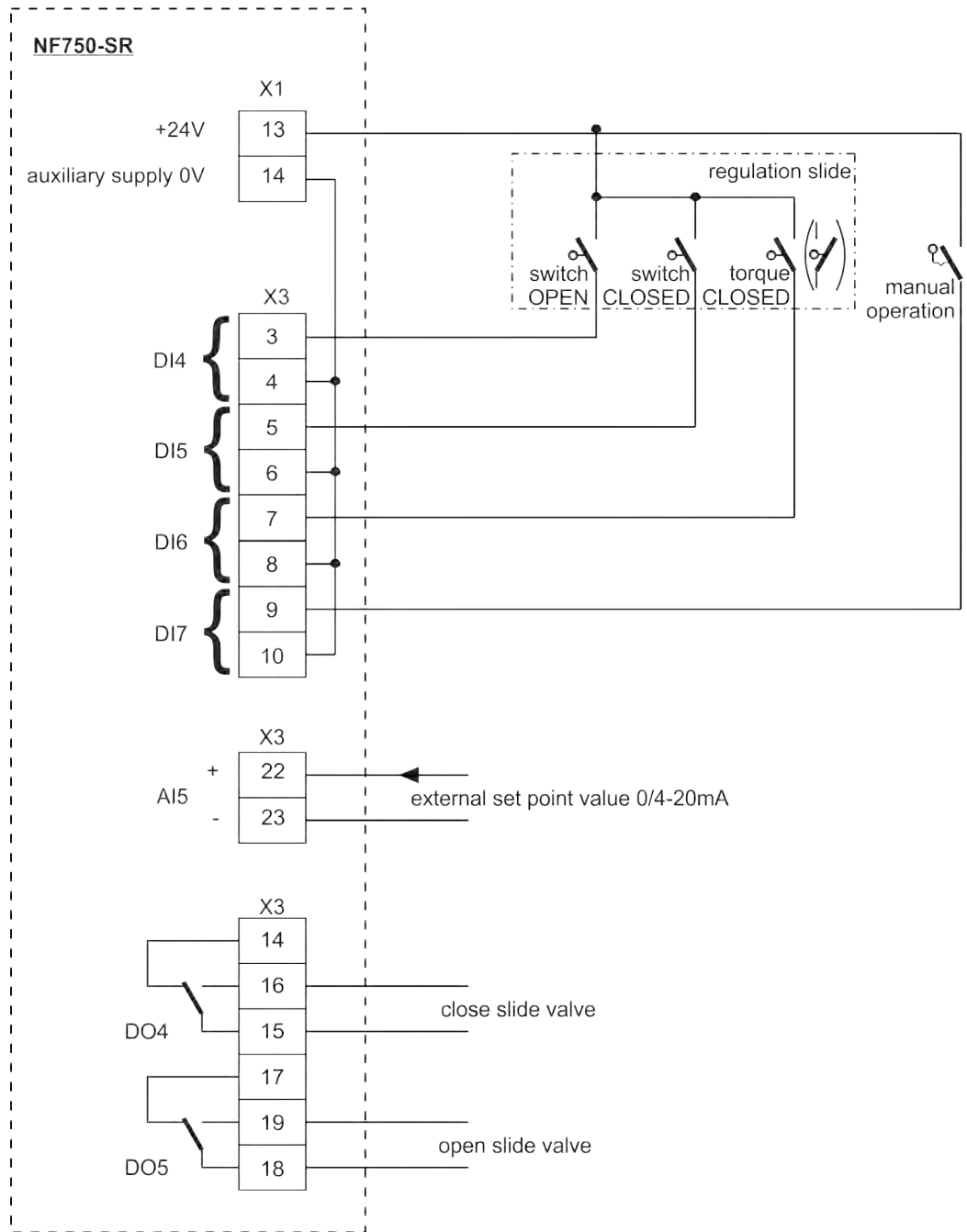

Fig. 24-2 Wiring diagram control operation NF750 Type SR

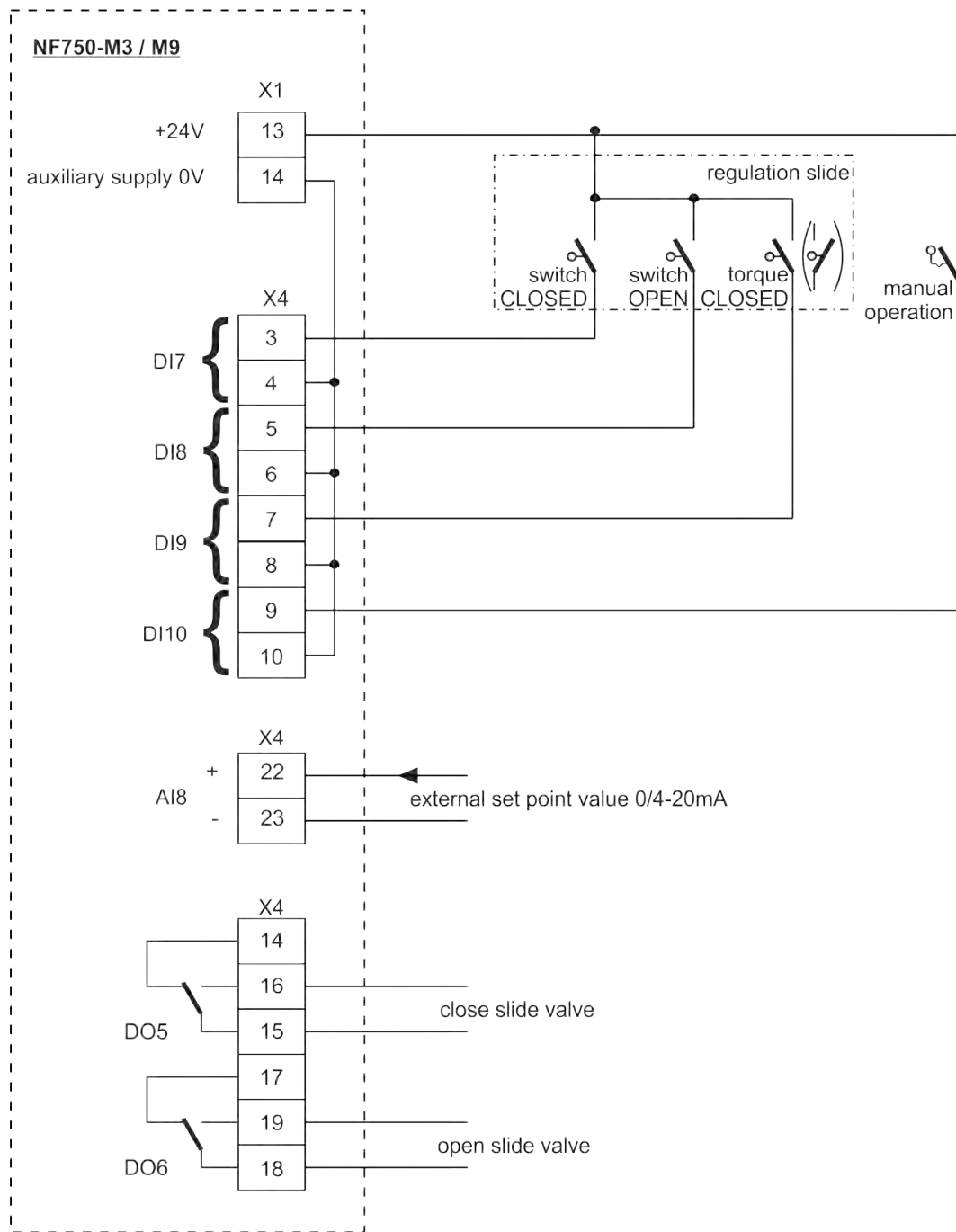

Fig. 24-3 Wiring diagram control operation NF750 Type M3 / M9

24.4 Control Algorithm



Important note

For slide valve control by using the digital inputs **always** use all three messages.
Activating only one message may lead to errors during control operation.

For control function activate relay 4 for the >Close slide valve< function and relay 5 for >Open slide valve<. This assignment **cannot** be changed.

For correct and monitored slide valve control necessarily use the >Way closed<, >Way open< and >Torque closed< messages from the slide valve drive.

The input current of the digital inputs is 10 mA each.

The controller can be operated either by using an external or an internal setpoint. External setpoints **always** shall be connected to AI5.

A 4...20 mA-signal if used as external setpoint can be monitored regarding cable breaks and short-circuit. In case of errors the transmitter then uses the internal setpoint. Due to this, when using the external 4...20 mA setpoint with error monitoring **always** additionally set the internal setpoint.

The following relationship applies for the calculation of the **slide valve actuating time**:

$$\text{Actuating Time} = (\text{Setpoint} - \text{Flow rate}_{\text{actual value}}) \cdot \text{P_Factor} \cdot \frac{\text{max. slide valve runtime}}{\text{max. flow rate}}$$



Note

Since comprehensive skills and knowledge in control engineering are required for controller programming a more detailed description will not be given here.

In case of uncertainties contact the NIVUS commissioning service.

25 Special Functions NivuFlow 750 Type M9

25.1 General

The NF750 Type M9 transmitter is a special version within the NF750/700 transmitter line. It is designed to manage up to nine flow velocity sensors and to calculate one to three flow measurement places depending on the model version.

Areas of use

- If used with applications featuring only **one measurement place** Type M9 is primarily suitable for
 - very wide channels (width of several meters) and/or
 - significant structuring (dry weather flumes, embankments or similar),
 - profiles with heavy hydraulic disturbances and
 - very high requirements to measurement accuracy.
- Type M9 transmitters featuring options to calculate and to manage **two or three measurement places** are used when
 - only confined space conditions are available to install the transmitter while retro-fitting and/or

- several flow measurement results must be combined as overall flow rate total or
- a second subtotal is to be calculated from one measured total and partial flow rate.
- Moreover the complex design of this type permits to additionally integrate external flow rates (e.g. 4...20 mA signal from external EMF) into the calculated total.

Application/measurement place 1 can be set as **step controller**. All further measurement places cannot be used for such purposes since there are not enough digital hardware inputs and outputs available.

25.2 Connection of Flow Velocity Sensors

When using Type M9, the flow velocity sensors as well as the according level sensors are **always** connected to the transmitter by using an iXT Ex Separation Module or an MPX Multiplexer, **never** directly to the transmitter itself.

Up to 3 flow velocity sensors can be connected to each iXT or MPX.

Number of sensors	Number of Ex Separator Modules/Multiplexers
1...3 sensors	1x iXT/MPX
4...6 sensors	2x iXT/MPX
7...9 sensors	3x iXT/MPX

Internally the sensors are numbered consecutively from the first to the third iXT/MPX:

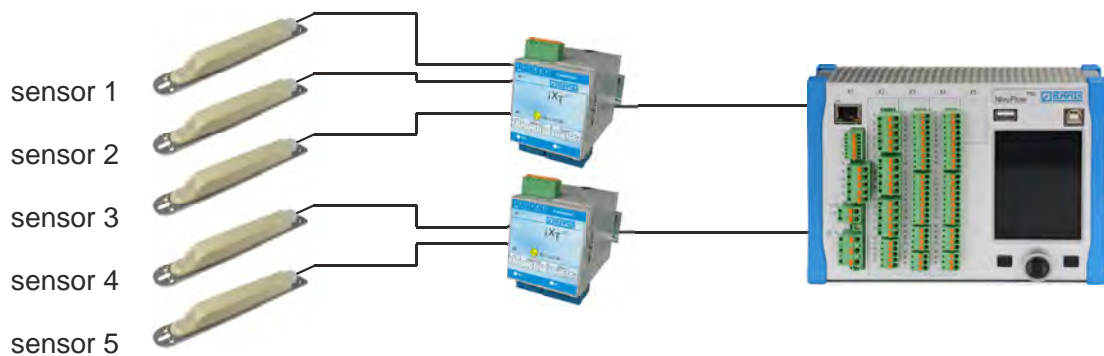

Fig. 25-1 Sensors numbering

Sensor 1 is always the **guide sensor**. The entire transmitter programming relates to this sensor and its position within the channel.

If an application uses a **combi sensor** (wedge sensor with integrated pressure measurement cell) this sensor **always** must be labelled as **Sensor 1** (guide sensor) of this application.

If the next application uses a combi sensor as well, this sensor is Sensor 1 (guide sensor) of the second application.

Intelligent Ex Separator Module iXT

The following devices can be connected to an iXT Ex Separation Module:

- POA-V2 Zone 1
- CS2 Zone 1
- i-sensor Zone 0
- NivuBar Plus Zone 1
- 2-wire sensors from other manufacturers (provided the Ex approval meets the requirements)
- Air-ultrasonic sensor OCL Zone 1
- EBM Electronic Box

DANGER



Danger of Explosion connecting external 4...20 mA Signals (Level)

Do not connect external 4...20 mA signals (coming from other transmitters) to Type M9 transmitters in Ex zone applications due to safety reasons, neither directly to the transmitter nor to the iXT Ex Separation Module.

Disregarding may lead to personal injury.

Multiplexer MPX

The following devices can be connected to a MPX Multiplexer:

- POA-V2
- CS2
- i-sensor
- NivuBar Plus
- 2-wire sensors from other manufacturers (provided that the permissible voltage and the load are the same)
- Air-ultrasonic sensor OCL
- EBM Electronic Box
- Up to 2 external 4...20 mA level signals (e.g. from NivuMaster)

Connection of analog and digital inputs

Analog and digital inputs (free readings from other instruments, external controller setpoint, measurement release, slide valve end position etc.) are connected directly to the transmitter and not to iXT/MPX.

Numbering and connection of sensors for more than one application

Each application may include a different number of flow velocity sensors (up to a max. of 9 pcs.). Example:

- Application 1: one flow velocity sensor
- Application 2: five flow velocity sensors
- Application 3: two flow velocity sensors

All sensors are numbered consecutively, i.e. flow velocity sensors 1...3 are connected to iXT/MPX 1, flow velocity sensors 4...6 to iXT/MPX 2 etc.

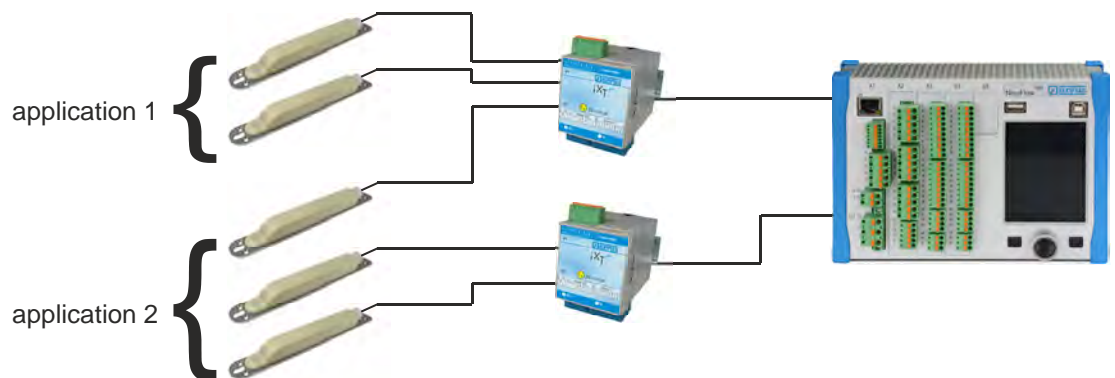

Fig. 25-2 Numbering/connection for several applications (option 1)

The iXT/MPX units do not need to be fully wired. It is possible to leave sensor connections unconnected. In the parameterisation, these sensors are then to be parameterised/displayed as "not active".

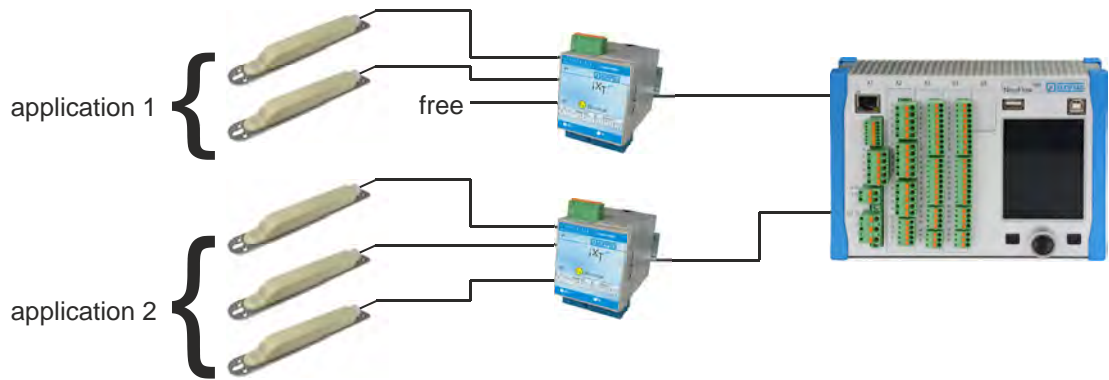

Fig. 25-3 Numbering/connection for several applications (option 2)

25.3 Connection of Level Sensors

The level sensors of application 1 are connected to iXT/MPX 1, the level sensors of application 2 to iXT/MPX 2 and the level sensors of application 3 are connected to iXT/MPX 3 even if the accompanying v-sensors of the according application are **not** connected there.

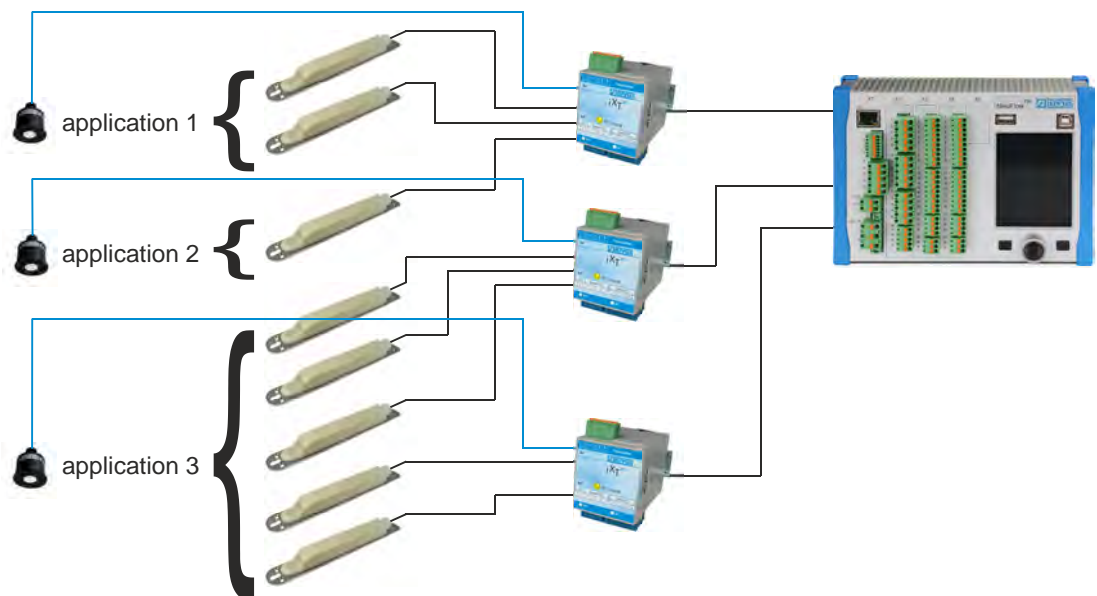

Fig. 25-4 Connection of level sensors

Level measurement with pressure measurement cell (combi sensor)

If the pressure cell of sensor 1 is used as level measurement for application 1 and the pressure cell of sensor 2 as level measurement for application 2, level measurement 1 must be connected to sensor 1 on iXT/MPX 1 and level measurement 2 must be connected to sensor 2 on iXT/MPX 2.



Fig. 25-5 Pressure cell for level measurement

Level measurement in Ex areas

Intelligent i-Sensors shall be used in combination with Type M9 transmitters in Ex areas only if they have the appropriate Ex approvals available.



Important note

An approval for Ex zone 0 is required. The approval of the i-Sensors for Ex zone 1 is an approval according to pressure encapsulation. However, only intrinsically safe powered sensors (i-Sensor intrinsically safe powered = Zone 0) may be connected to the iXT.

The i-Sensor Ex-Zone 0 is connected to the iXT and not directly to the transmitter.

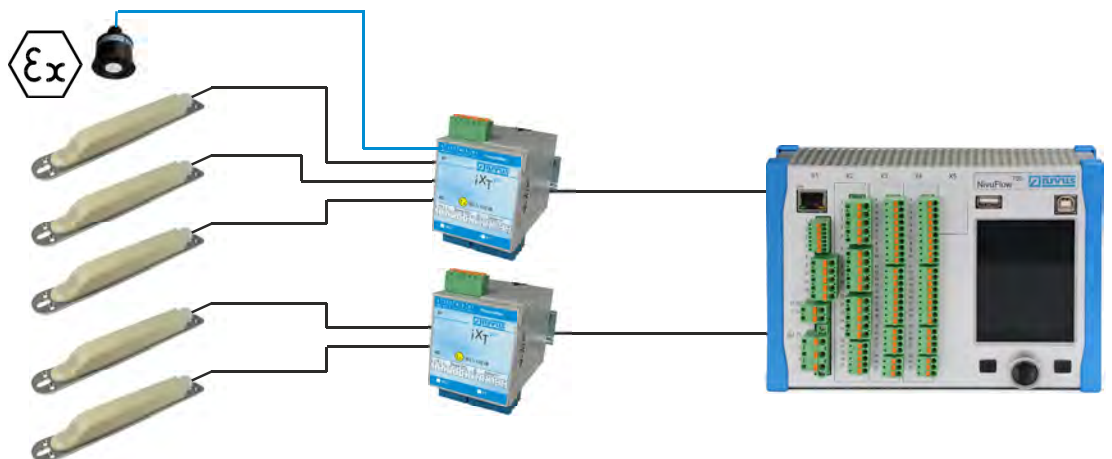

Fig. 25-6 Connecting an i-Sensor in Ex area

25.4 Connecting the Ex Separation Module/Multiplexer to NivuFlow 750 type M9 Transmitters

The iXT Ex Separation Module or the MPX Multiplexer are connected using the X2 terminal strip.

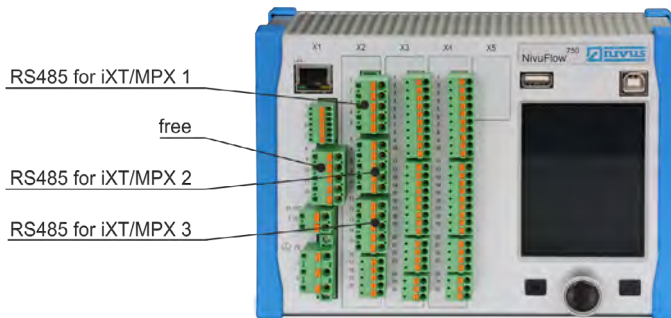

Fig. 25-7 Connection to NivuFlow 750 type M9

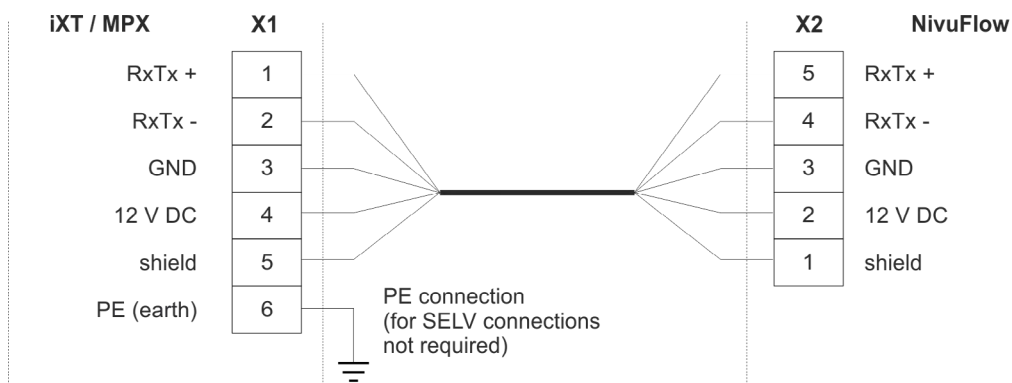

Fig. 25-8 Connection of 1st iXT/MPX to NF750 type M9

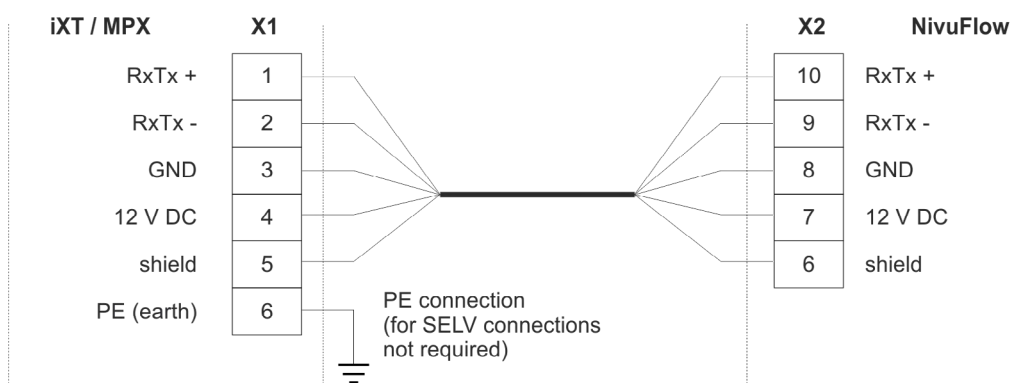

Fig. 25-9 Connection of 2nd iXT/MPX to NF750 type M9

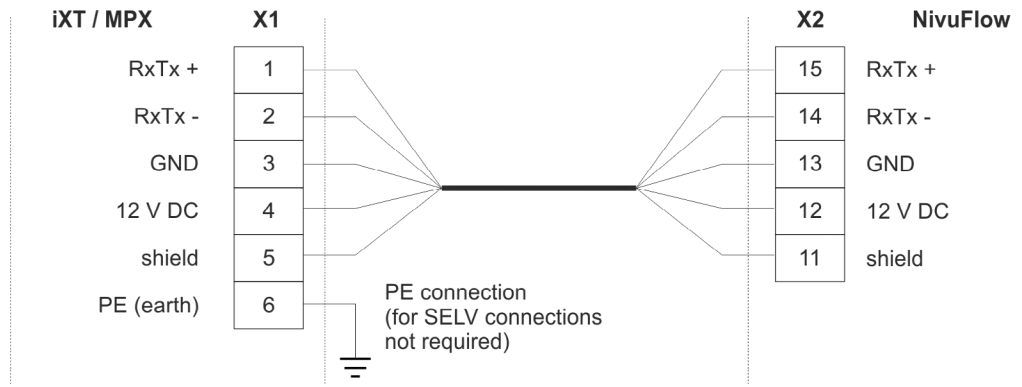

Fig. 25-10 Connection of 3rd iXT/MPX to NF750 type M9



You can find more information on the connection between iXT or MPX, cable types, maximum distances, overvoltage protection etc. in the “Technical Description of iXT0 Ex Separation Module” or the “Technical Description of MPX Multiplexer”.

26 Overvoltage Protection

Due to being equipped with surge arresters in the power supply section and the sensor connection area the NivuFlow transmitter provides basic overvoltage protection. For effective protection of the NivuFlow transmitter it is necessary to protect power supply as well as mA-output using additional external overvoltage protection devices. NIVUS recommends surge arrestors types EnerPro 220Tr, EnerPro 24Tr (for 24 V C) for the mains supply, as well type DataPro 2x1 24/24Tr for mA-inputs and mA-outputs. The flow velocity sensor as well as the air-ultrasonic sensor type OCL-L1 are internally protected against overvoltage. If higher voltages are expected to occur they can be protected by combining the types DataPro 2x1 12 V/12 V 11µH-Tr (N) as well as SonicPro 3x1 24 V/24 V.



Observe connection loads, capacity and inductance

If using the sensors in Ex areas consider the connected loads of the overvoltage protection devices as well as capacity and inductance of the NIVUS sensor cables (OCL-L1) additionally!

The maximum permissible NIVUS cable lengths in Ex areas are:

- *Single-side overvoltage protection: 135 m*
- *Double-side overvoltage protection: 120 m*



Reduction of the possible cable length

The use of overvoltage protection elements for sensors in Non-Ex areas will reduce the maximum possible cable length.

The line resistance is 0.3 Ohm/wire. This resistance must be taken into account considering the allowed total resistance (see “Technical Instructions” and/or “Instruction Manuals” of the sensors for details).



Observe the connection direction

Observe the non-reversed connection (p-side to transmitter) as well as a correct, straight wiring supply.

Ground (earth) must lead to the unprotected side.

The overvoltage protection devices are ineffective if wired incorrectly.

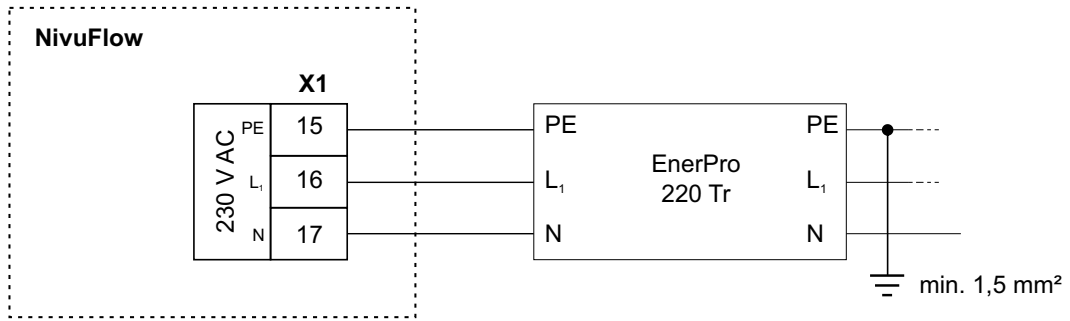

Fig. 26-1 Overvoltage protection for power supply AC

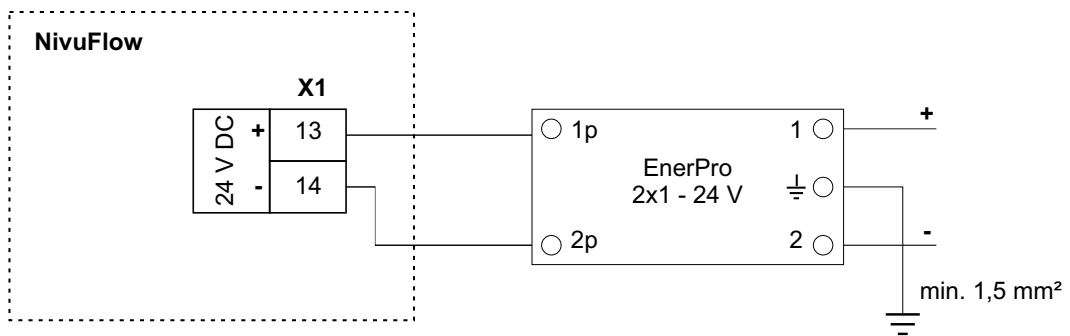

Fig. 26-2 Overvoltage protection for power supply DC

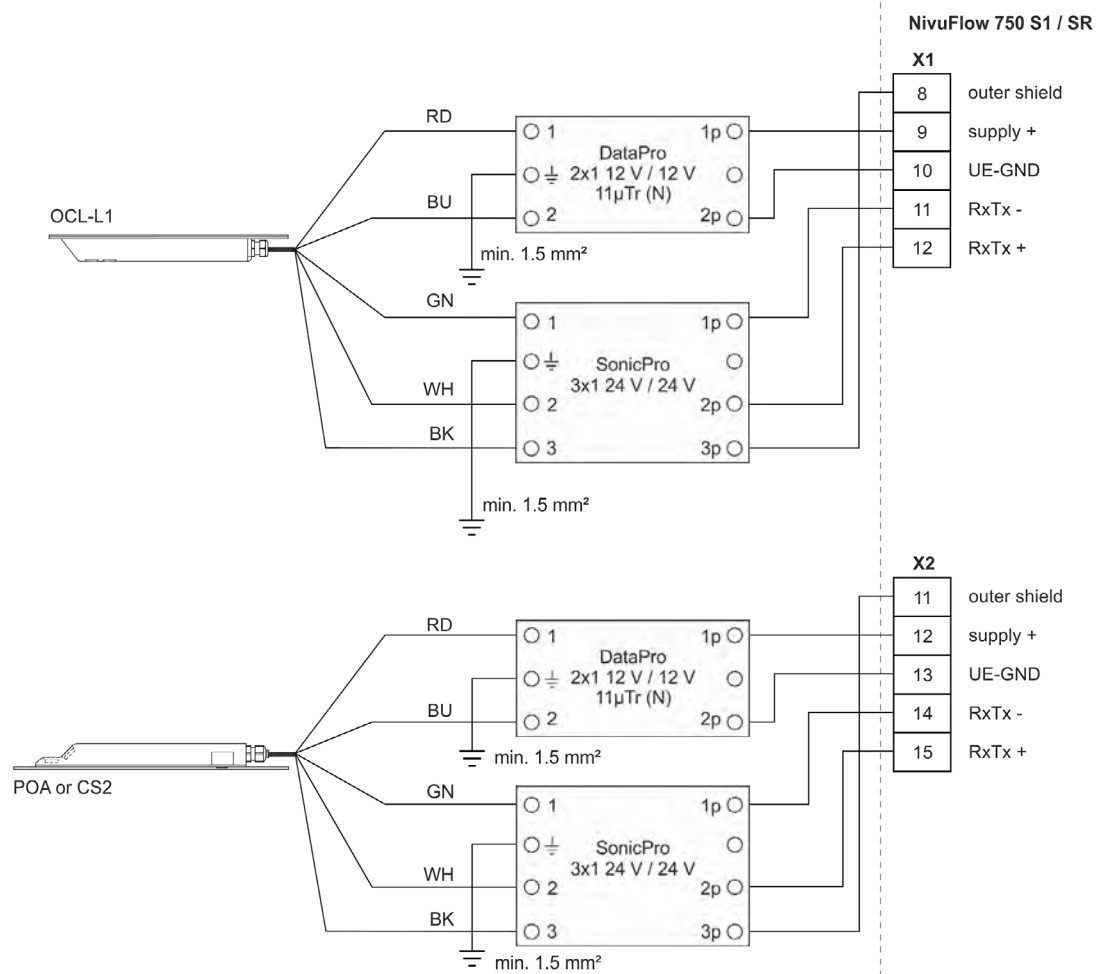

Fig. 26-3 Sensor overvoltage protection for S1 / SR

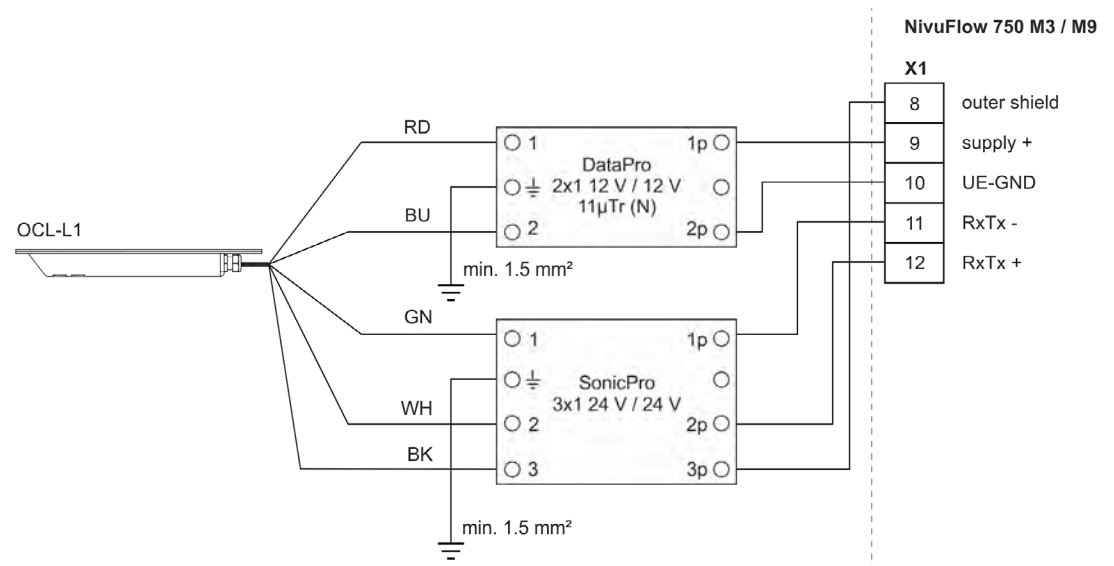

Fig. 26-4 Overvoltage protection for air ultrasonic sensor OCL to M3 / M9

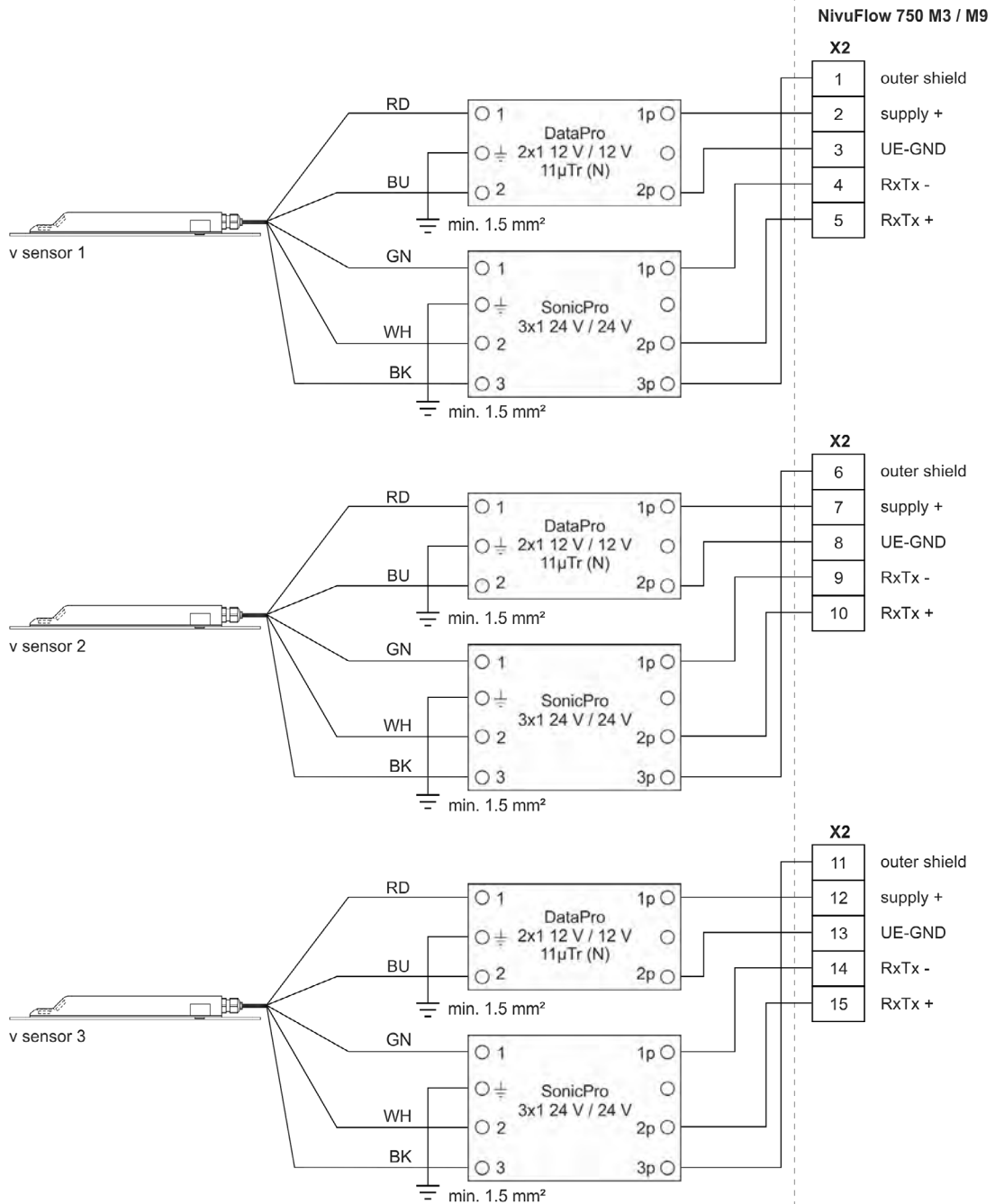

Fig. 26-5 Overvoltage protection for flow velocity sensors to M3 / M9

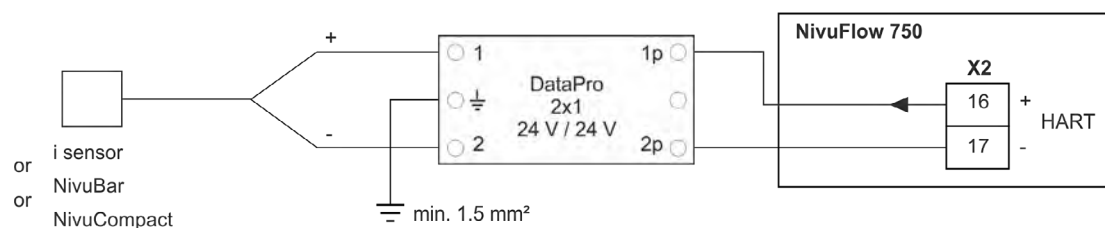

Fig. 26-6 Overvoltage protection external level measurement

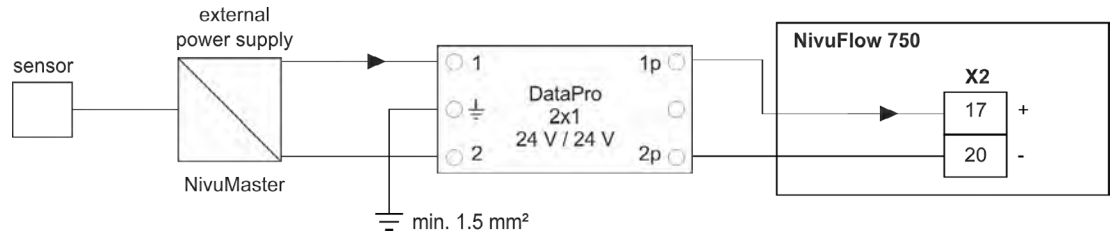

Fig. 26-7 Overvoltage protection of input from external transmitter

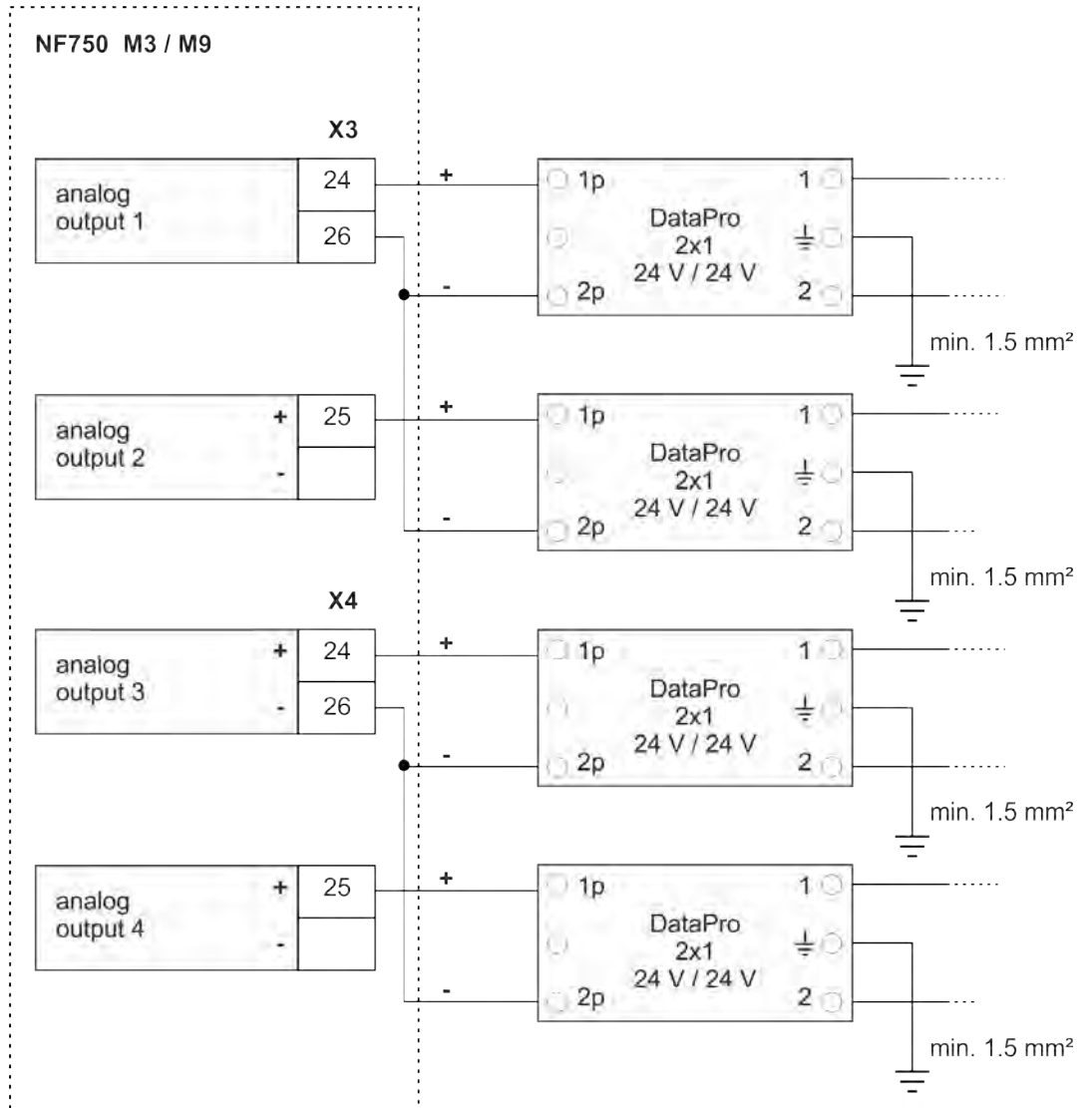

Fig. 26-8 Overvoltage protection of analog outputs NivuFlow 750 type M3 / M9

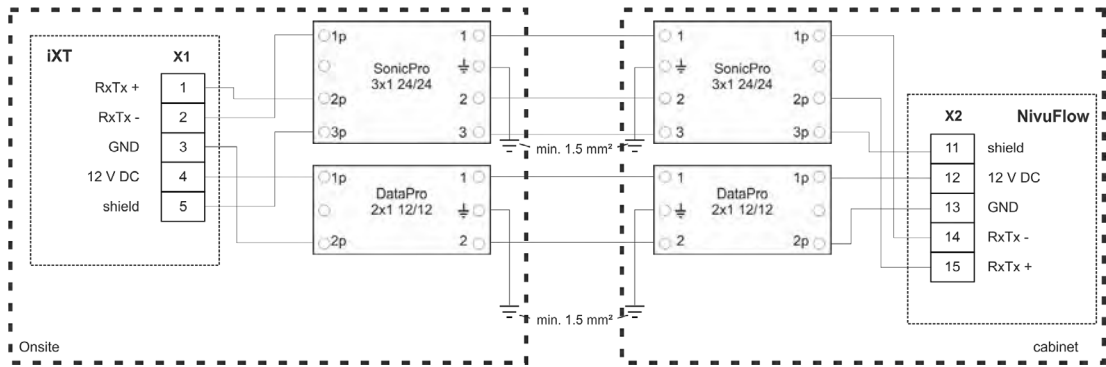

Fig. 26-9 **Overvoltage protection iXT to NivuFlow 750/700 type S1 / SR**



Notes on electrical discharge (grounding)

The minimum wire cross section is 1.5 mm² (not for strands).

The maximum permissible cable length of the arrester is 1 m. In addition, it must be laid on a down conductor rail.

Operation start-up

27 Notes to users

Before connecting and operating the NivuFlow the instructions below shall be followed.

This instruction manual contains all information required for the setting of parameters and for the use of the instrument. The manual is intended for qualified personnel. Appropriate knowledge in the areas of measurement systems, automation technology, control engineering, information technology and wastewater hydraulics are preconditions for putting the NivuFlow into operation.

Read this instruction manual carefully in order to guarantee proper function of the NivuFlow.

The NivuFlow shall be wired according to the wiring diagram in chapter "22.2 Plans of terminal connections".

In case of doubt regarding installation, connection or the setting of parameters contact our hotline:

- +49 7262 9191-955

General principles

The system shall not be put into operation before the installation has been finished and checked.

Follow the hints in the instruction manual to eliminate the risk of faulty or incorrect setting of parameters. Before you begin to set parameters, get familiar with the transmitter operation using entry wheel, function keys and display.

The connection of transmitters and sensors (according to chapter "22.1 Connection to the Terminal Blocks" and "23.4 Sensor Connection at NivuFlow") followed by the setting of the measurement place parameters.

In most cases it is sufficient to set:

- Shapes and dimensions of the measurement place
- Sensors used and the according positions in the application
- Working range of the sensors used
- Display units and language
- Function and span of analogue outputs as well as function and corresponding detailed parameterisation of digital outputs

The user surface of the NivuFlow is easy to understand. Users can make all required **basic settings** themselves.

In case of the following requirements let either NIVUS or an expert company authorised by NIVUS set the parameters:

- Use of measurement transmitter NF750 type M9
- Extensive programming tasks
- Difficult hydraulic conditions
- Special channel shapes
- Controller adjustments
- If the service specification requires a protocol on settings and errors
- Not specially trained qualified personnel or little experience in measurement systems

28 Operation Basics

The complete operation of the NivuFlow is handled via control elements (see chapter "2.2 NivuFlow control elements"). Two control buttons and one rotary pushbutton are available for the setting of parameters and to input required data.

The display at any time provides information on where you currently are within the menu structure and which entries you are about to modify.

28.1 Display Overview

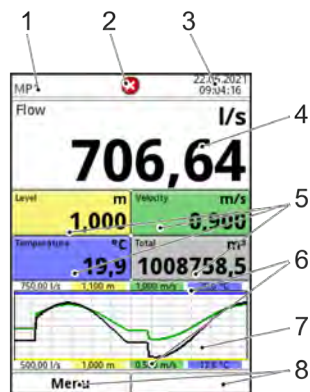

- 1 Name of measurement place
- 2 Error message sent, system status information or display for active programming or service mode
- 3 Date/time
- 4 Display area 1 (output field 1 for the flow rate)
- 5 Display Area 2 (output field 2...5 for level, wetted hydraulic area, analogue output X, medium temperature, air temperature, totals, daily average or, with the combi measurement place of the NF 750 Type M9, for measurement place 1/2/3 and totaliser)
- 6 Automatic scaling for display area 3 (Pos. 7)
- 7 Display area 3 (trend graph on level, velocity, medium temperature and flow rate)
- 8 Assignment of function keys

Fig. 28-1 Display overview (with default settings)

28.2 Using the Control elements

- First, select the >main menu<. Press the left hand function key.
 1. Turn the rotary pushbutton to scroll through the menu. A sub-menu can be selected, as soon as it is highlighted blue.
 2. Press the black part of the rotary pushbutton - you will get to the next parameter level or you can enter parameter settings.
 3. Repeat this process until you arrived at the desired menu or parameter.

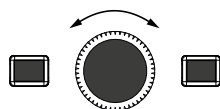

Here you can enter names or numbers in parameters.

- ➔ See chapter "28.3 Use/Entry using the letter block" and "28.4 Use/Entry using the numeric keypad".

Press the left hand function key to exit the menus step by step.

The transmitter in the background operates with the settings which have been entered at the beginning of the parameter setting.

The following prompt for saving the changed parameters does not appear in the display before the current parameterisation process has been completed and confirmed.



Fig. 28-2 Confirmation after parameter setting

➡ Confirm the entry with >YES<.

The password query for the parameter settings appears:

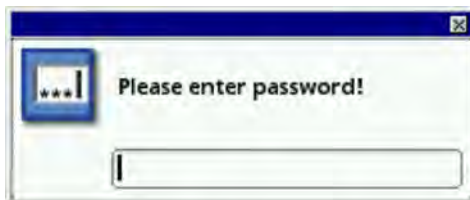

Fig. 28-3 Password query for parameter settings

➡ Enter the password (default setting "2718").

After accepting the new parameters the NivuFlow continues to operate using these data.

Depending on the programming, the transmitter restarts the evaluation and calculation in the background. To prevent the display and analogue and digital outputs from going to "0" or putting out errors or limit violations that do not make any sense at this moment, the transmitter holds the display and output of the last measured value for a period of about 10...20 seconds after programming has ended. This state is represented by showing an "H" (= Hold) in the upper line of the display (Fig. 28-4). As soon as the new valid measurement values are available, this "H" disappears and the transmitter returns to the display and output of the newly determined valid measurement values.

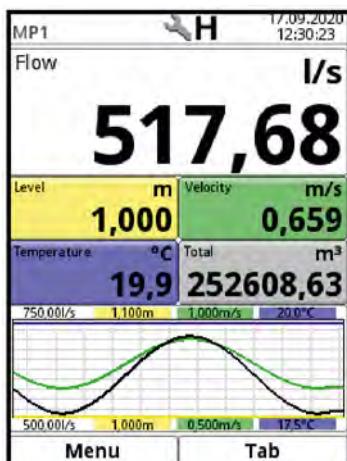
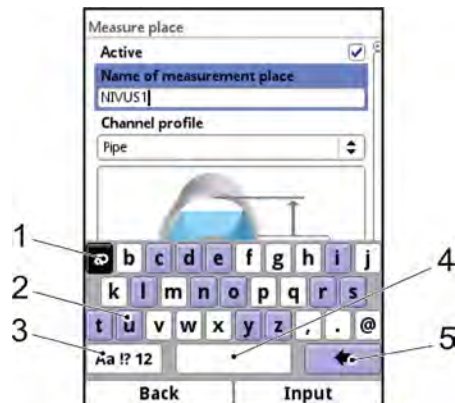

Fig. 28-4 Main Screen with Hold Symbol

28.3 Use/Entry using the letter block

Certain parameters can be labelled with names or designations. A virtual keypad is indicated in the bottom section of the display if such a parameter has been selected.



- 1 Selected character
- 2 Dual function character
- 3 Shift (upper/lower case)
- 4 Space
- 5 Back or delete button

Fig. 28-5 Keypad



Note

The use of the key pad is explained here one time. Later in the manual you will be prompted to enter designations or names following this explanation.

A shift key can be found at the bottom left of the keypad (Fig. 28-5 Pos. 3).

- The functions of the shift key are:
 - Upper case
 - Lower case
 - Special characters
 - Digits
- These settings allow individual names of the measuring place almost without limitations.
- To **activate** this shift key rotate the rotary pushbutton until the shift key is highlighted black.

➡ To **enter** designations such as the measurement place name proceed as follows:

1. Turn the rotary pushbutton to scroll to the lower half of the display. A virtual keypad featuring individually selectable letters is indicated.
2. Turn the rotary pushbutton to navigate through the virtual keypad. Characters highlighted blue (Fig. 28-5 Pos. 2) feature dual functions. Holding the button depressed for approx. 1 sec. switches over to alternative function.
3. Press the rotary pushbutton until the desired character is highlighted black. By pressing the character is applied to the text box automatically.
4. Repeat this process until the complete name is on the display.

28.4 Use/Entry using the numeric keypad

In certain parameters it is possible to enter dimensions or other numeric values. A number field (analogous to letter block) is indicated in the bottom section of the display if such a parameter has been selected.



Note

The use of the numeric key pad is explained here one time. Later in the manual you will be prompted to enter dimensions or numerical values following this explanation.

- Press the rotary pushbutton - a numeric field will appear:
 1. Enter the values digit by digit. Proceed the same way as described before in the keypad section.
When entering the dimensions observe the correct decimal places. The channel profile dimension e.g. is set to METER per default.
- If **multiple dimensions** shall be entered consecutively (e.g. for rectangular profiles), you can get to the next dimension by rotating the rotary pushbutton after your former entry has been confirmed. For the next entry proceed right as described before.

28.5 Revision of parameters

- Incorrect entry can be deleted letter by letter or digit by digit by pressing the back button:
 1. Open the keypad.
 2. Turn the rotary pushbutton until you get to the >back arrow< (back button) (Fig. 28-5 Pos. 5).
 3. Press the rotary pushbutton - this will erase the latest wrong letter or number. Repeat the process as often as necessary.
- Write subsequently until the complete name or dimension appears in the display and confirm the entry with the right hand function key.
The name of measurement or the numerical value is taken to the main menu and is displayed there.

28.6 Menus

All menus are described in a logical programming order in chapter "Setting Parameters".

There are at least six basic menus available. With only one measurement place for types S1, SR and M3 there are exactly six, with type M9 up to nine basic menus, because instead of the menu >Application< up to 3 both individual measurement places as well as the combined one are displayed.

The basic menus can be viewed and selected by pressing the right function key.

The menus are:

Application or Names of Measurement Places	It guides the commissioning personnel through the entire setting of parameters for the dimensions of measurement places, selection of sensors and analog and digital inputs and outputs, controlling functions and diagnoses.
Data	<ul style="list-style-type: none"> • Visually indicate charts on flow rate, level, medium temperature and (average) flow velocity • Display and option to reset different flow totals • Save data, erase memory • Save and load parameters • Format USB stick • Modify storage cycles and totals • Display of the daily and total transmitter operating hours as table

System	<ul style="list-style-type: none"> • Recall basic information on the transmitter and the connected sensors such as serial no., version, article no. and many more (needed in the event of queries) • Settings such as language, time and data format as well as indicated/saved (measurement) units can be modified in the >Country settings< • System time and time zones can be found in the >Time/Date< sub-menu • Error messages are available in the according sub-menu • Service levels, password changes, activation of optional functions, reset and restart of the measurement system
Communication	<p>Setting parameters for all communication interfaces of the NivuFlow such as TCP/IP, web server, data transmissions, alert messages as well as Modbus.</p>
Display	<ul style="list-style-type: none"> • Input of basic parameters such as backlighting, dimming of the display as well as (partial) definition of the type of display in the main display. • Format of the output fields (text, decimal places etc.) can be set
Connections	<ul style="list-style-type: none"> • Activation of the possible connections for Ex-Separator Module iXT and Multiplexer MPX • With Type M9 allocation of: <ul style="list-style-type: none"> ▪ connections for flow velocity sensors to the individual measurement places ▪ digital/analogue inputs and outputs to the measurement places

Tab. 28-6 Overview Basic Menus

Main Screen

Quick Access

In addition to displaying the values themselves, the main screen also allows for direct access to the most important setting parameters.

The quick access enables to directly jump to important individual menus without having to go through the (sub)menus of the parameterisation. It hence serves as quick and uncomplicated check of the individual sensors involved in the measurement.

Quick diagnosis, uncomplicated parameter adjustment and adjustment are possible by using the quick access. Direct queries for basic device data such as serial and article numbers as well as the firmware version of the transmitter and the connected sensors are also possible in just a few steps.

29 General Overview



Note on the Displays and Descriptions in the Manual

Depending on the equipment/transmitter type, the descriptions and display illustrations may differ from those shown in the instruction manual.

Multiple measurement places or a combi measurement place are available only with the NivuFlow 750 Type M9. The same applies to the equipment of a regulator with NivuFlow 750 Type SR or M9. These illustrations and descriptions are not valid for the respective other transmitter types.

The following information is provided in the **top area** of the display:

- Name of the measurement place
- Date (alternatively 1, 2, 3 etc.; see Fig. 30-1)
- Time (alternatively 1, 2, 3 etc.; see Fig. 30-1)

The **red full circle with a white cross** in the top display area indicates pending errors in the system or individual sensors.

The **service key** in this area indicates that the password has been entered within the last six hours and that all further **parameter changes** can be saved **without** having to enter the **password** again. The six-hour period begins when the password is entered once and ends automatically.

If a number is also displayed directly next to the service key, the transmitter is in service mode. This is usually the case when a NIVUS service technician has access to the transmitter.



See also Chap. “37.1 Save Parameters” and “28.2 Using the Control elements”.

In operation mode (with factory setting), the transmitter displays the following important measured values in the **main area**:

- Flow Rate
- Level
- Velocity (average calculated velocity)
- Medium Temperature
- Grand Total

The **bottom part** of the display shows a trend graph (hydrograph) and the assignment of the two control keys.

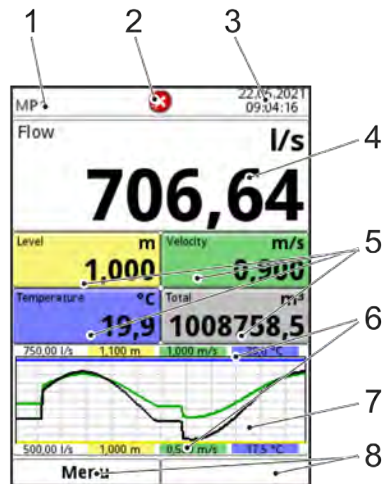

- 1 Name of the measurement place
- 2 Error message sent, system status information or display for active programming or service mode
- 3 Date/Time
- 4 Display Area 1 (output field 1 for the flow rate)
- 5 Display Area 2 (output field 2...5 for level, wetted hydraulic area, analogue output X, medium temperature, air temperature, totals, daily average or, with the combi measurement place of the NF 750 Type M9, for measurement place 1/2/3 and totaliser)
- 6 Automatic scaling for display area 3 (Pos. 7)
- 7 Display Area 3 (trend graph on level, velocity, medium temperature and flow rate)
- 8 Function displays for the assignment of the keys

Fig. 29-1 Main Screen Overview

With NivuFlow 750 Type M9 the **main screen switches** back and forth between the active measuring points, provided that switching is activated under >Switch Main Screen< (see Chap. "44 Parameter Menu Display").

With Type M9, it is possible to scroll **manually** between the individual measurement places using the **tab key**.

Direct access to the most relevant settings and information:

- ➡ Rotate the rotary pushbutton until the selected field is indicated black.
- ➡ Press the rotary pushbutton: the dialogue window of the according section opens.

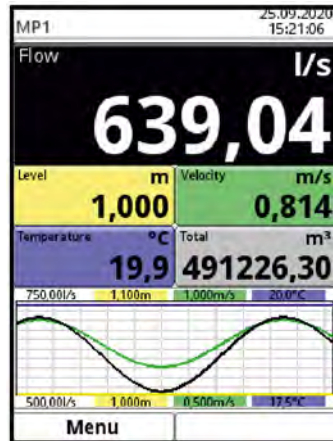

Fig. 29-2 Selected Screen Flow

**Note**

After changing system-specific parameters, the changes must be saved for them to take effect.

30 Display Field Flow

After activating the dialogue window by pressing the rotary pushbutton, the individual menus (Information, Diagnosis, Settings, Display and Error Messages) can be accessed via the pop-up menu (see Chapter “42.1 Information”, “Diagnostics”, “39.1 Setting the Measurement Place Parameters (Menu Application)”, “44 Parameter Menu Display” and “42.4 Error Messages”).

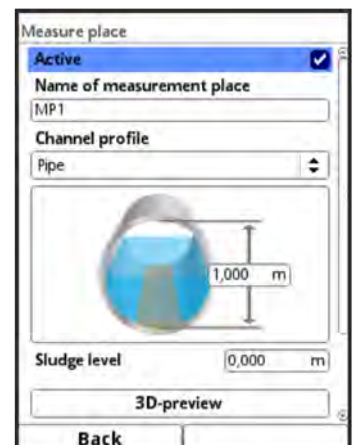
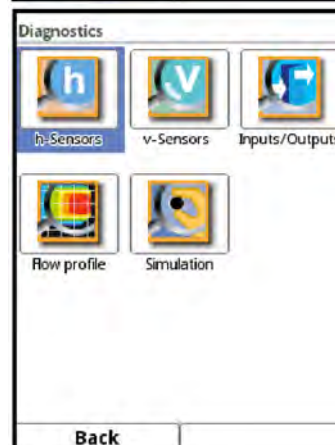
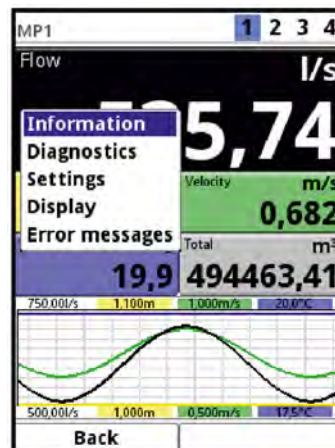
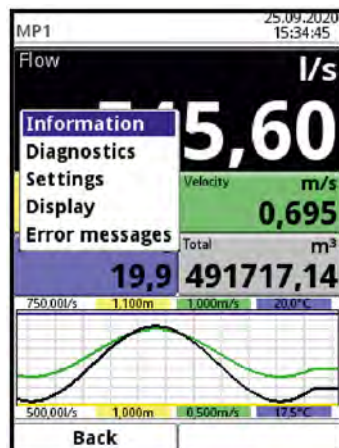

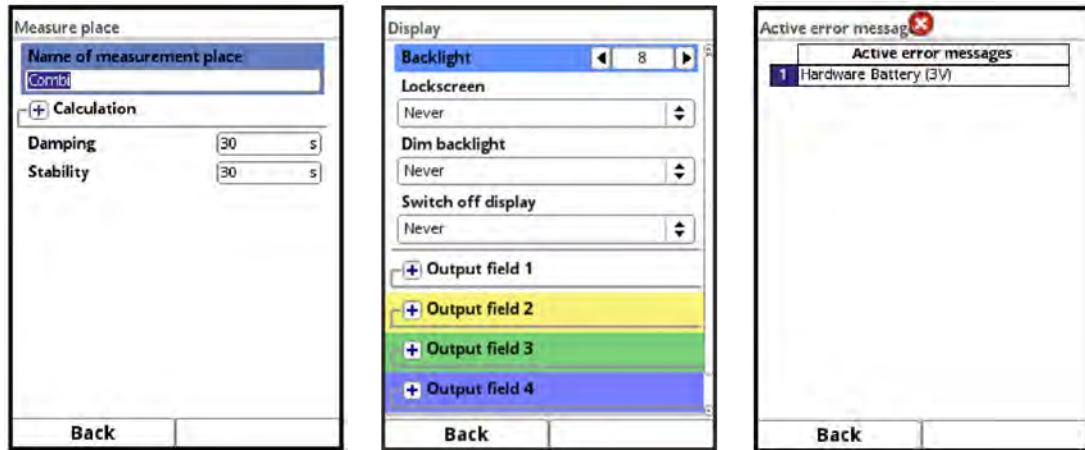

Fig. 30-1 Flow: Pop-Up-Menu and Menu Pages

31 Display Field Level (except combi measurement place NF 750 Type M9)

After activating the dialogue window by pressing the rotary pushbutton, the individual menus (Diagnostics, Settings and Display) can be accessed via the pop-up menu (see Chapter “47 Diagnostics h-Sensors”, “39.2 Setting Parameters in Menu h-Sensors” and “44 Parameter Menu Display”).

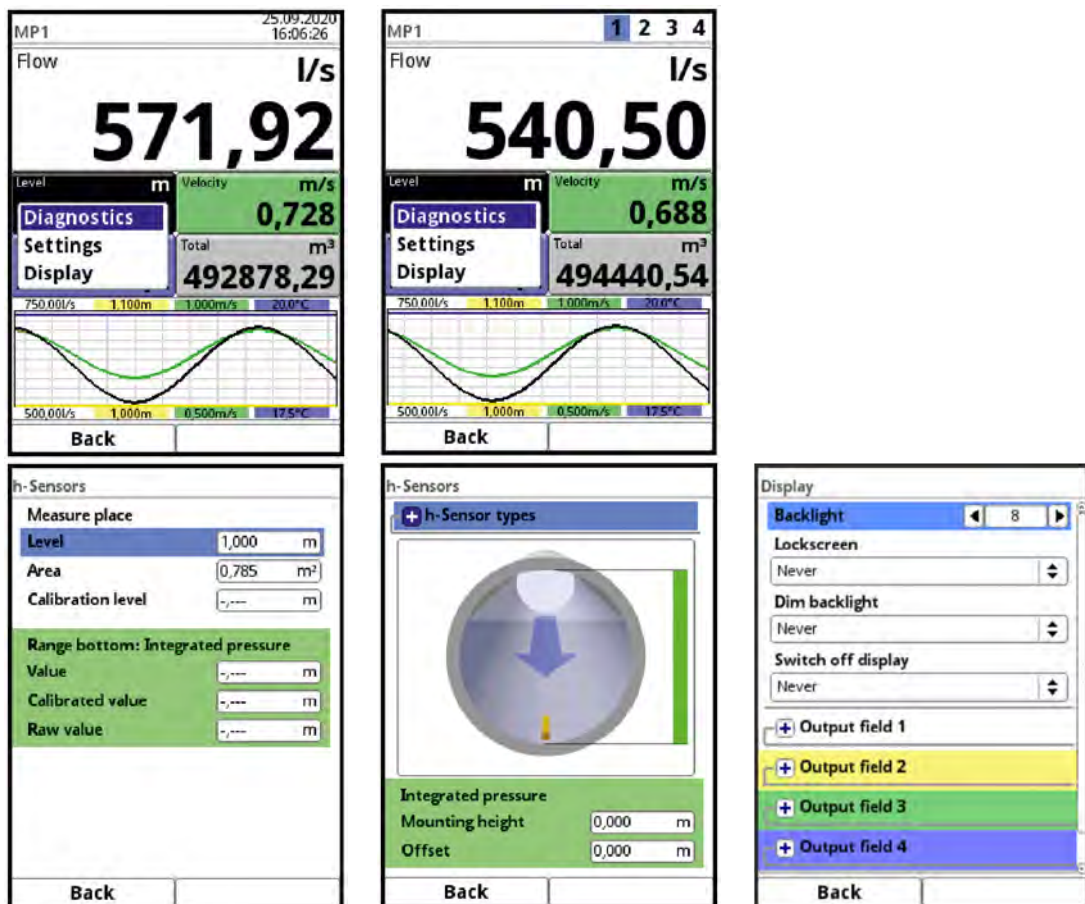

Fig. 31-1 Level: Pop-Up-Menu and Menu Pages

32 Display Field Velocity (except combi measurement place NF 750 Type M9)

After activating the dialogue window by pressing the rotary pushbutton, the individual menus (Diagnosis, Settings and Display) can be accessed via the pop-up menu (see Chapter “48 Diagnostics v-Sensors”, “39.3 Setting Parameters in Menu v-Sensors” and “44 Parameter Menu Display”).

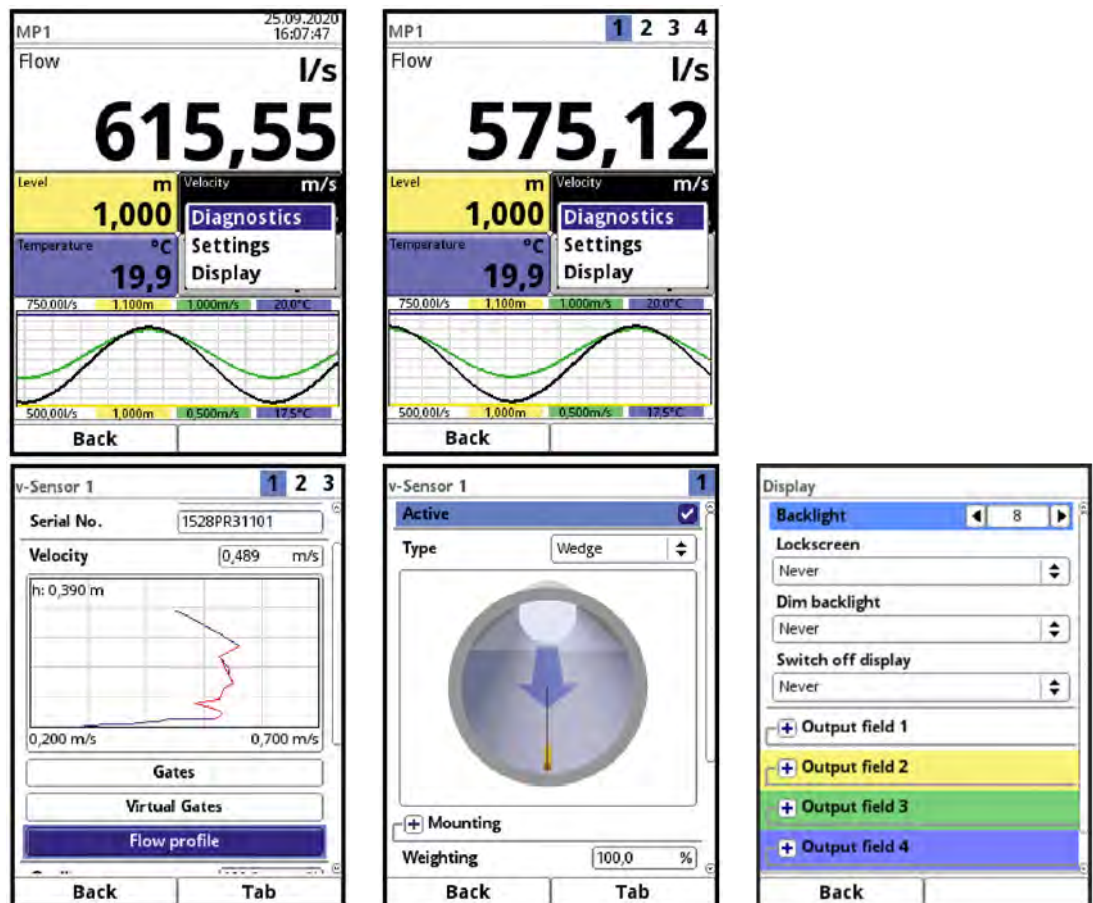

Fig. 32-1 Velocity: Pop-Up-Menu and Menu Pages

33 Display Field Temperature (except combi measurement place NF 750 Type M9)

After activating the dialogue window by pressing the rotary pushbutton, the menu Display can be accessed via the pop-up menu (see Chapter “44 Parameter Menu Display”).

If several flow velocity sensors are connected, the **temperature sensor** of flow velocity sensor 1 is used. The temperature is read automatically and the value is displayed.

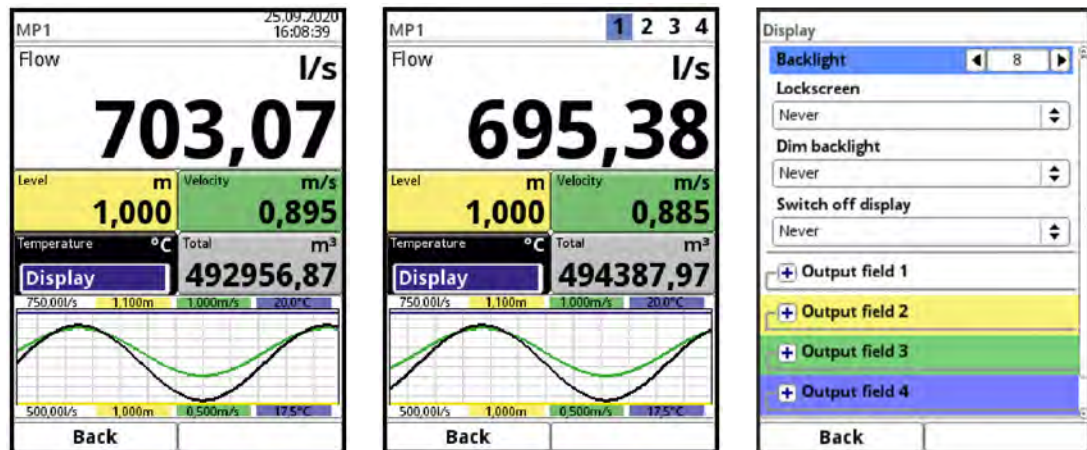

Fig. 33-1 Temperature: Pop-Up-Menu and Menu Page

34 Display Field Total

After activating the dialogue window by pressing the rotary pushbutton, the individual menus (Total, Daily Totals and Display) can be accessed via the pop-up menu (see Chapter “41.2 Total”, “41.3 Day Totals” and “44 Parameter Menu Display”).

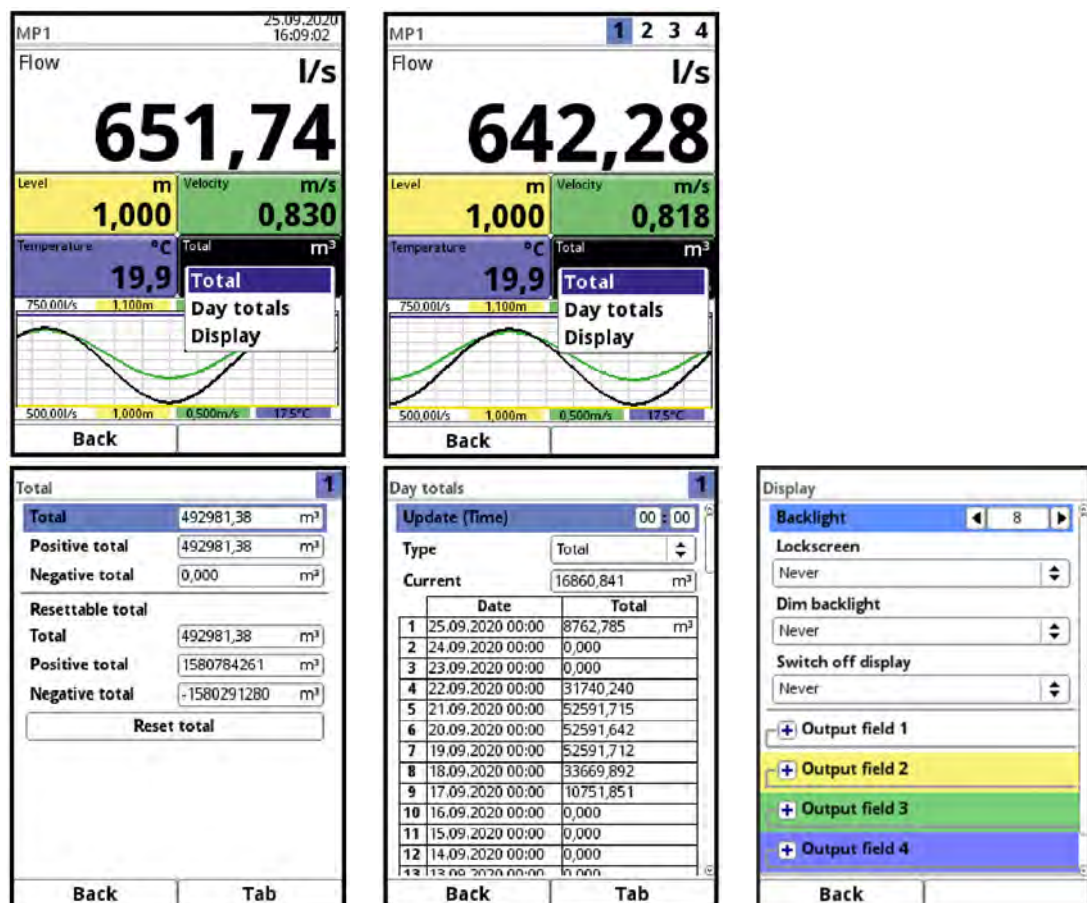

Fig. 34-1 Total: Pop-Up-Menu and Menu Pages

35 Display Field Trend/Hydrograph

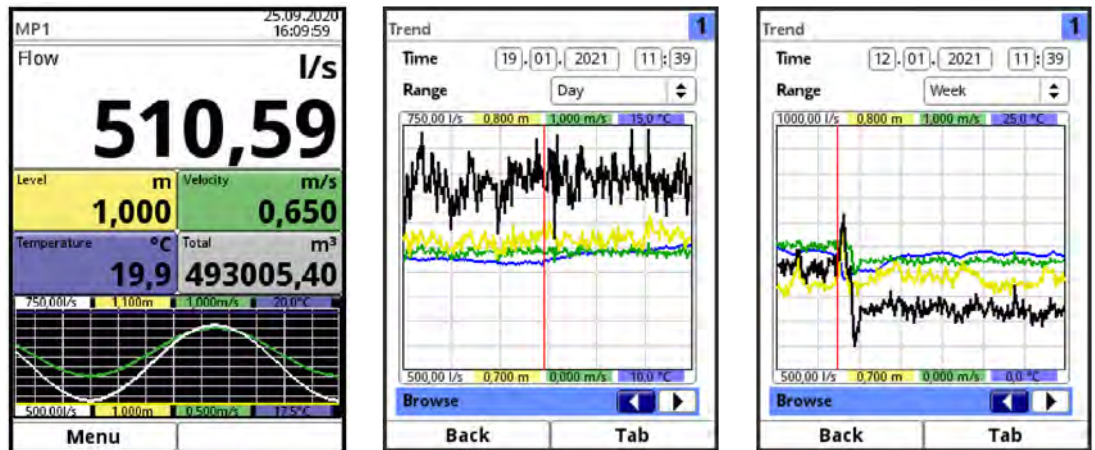

Fig. 35-1 Trend/Hydrograph: Pop-Up-Menu and Menu Pages

If a more detailed and extensive graphic display is required beyond the main display, the graphic field can be selected directly.

The display period and the display area are available for selection.

Different time periods can be displayed using the >Scroll< function (arrow keys below the diagram).

36 Display Field Measurement Place of Combi Measurement Place (with NF 750 Type M9 with several Measurement Places)

All three windows for the individual measurement places have the same structure.

After activating the dialogue window by pressing the rotary pushbutton, the individual menus (Diagnosis, Settings, Display and Error Messages) can be accessed via the pop-up menu (see Chapter “Diagnostics”, “39.1 Setting the Measurement Place Parameters (Menu Application)”, “44 Parameter Menu Display” and “42.4 Error Messages”).

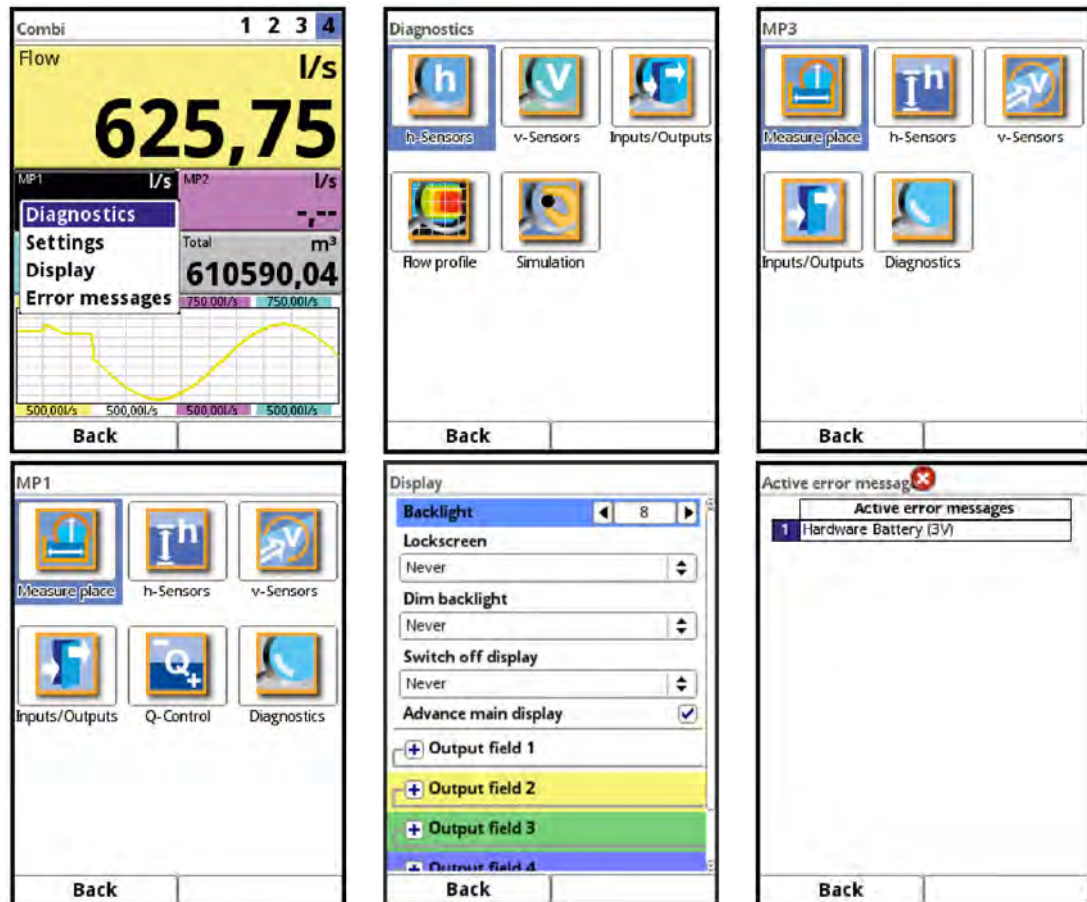

Fig. 36-1 Measurement Place (Combi): Pop-Up-Menu and Menu Pages

Setting Parameters

37 Basics

In principle, changed parameters do not become effective before they have been saved. When leaving any menus, the transmitter checks whether parameters have been changed. Finally, you will be asked whether you wish to save the parameters.

- >Yes<: the changed parameter setting is accepted and saved.
- >No<: the changes to the parameters are discarded and the transmitter exits the menus.
- >Cancel<: You exit the query, remain in the parameterisation and can continue with the adjustment of the parameters. The changed parameters are not yet effective and not saved.

37.1 Save Parameters

Enter a valid password to accept and save the parameters.

Default setting: 2718

The **service key** in the upper display area indicates that the password has been entered within the last six hours and that all further **parameter changes** can be saved **without** having to enter the **password** again. The six-hour period begins when the password is entered once and ends automatically.

This period and thus the unintentional change of parameters without password entry can be deliberately cancelled. To do this, select the >Service Level< under >System< / >Service<. When asked for the password, do **not** make an entry, but confirm the empty, untouched field with the right button >Enter<. The transmitter exits the mode with parameterisation without password entry.

If a number is displayed directly next to the service key, the transmitter is in service mode. This is usually the case when a NIVUS service technician has access to the transmitter.

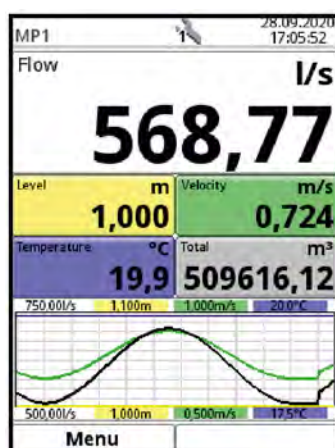

Fig. 37-1 Service Key - Service Mode

37.2 Change Password

➡ See also Chapter "42.5.1 Change (System) Password".

The default password can be changed at any time. Note that a changed password secures the changes to all transmitter settings. The input is limited to a maximum of ten characters.

➡ Procedure to change the password:

1. Open the >System< menu.
 2. Select the >Service< submenu.
 3. Activate the >Change Password< field.
 4. Enter the existing password by using the numerical field.
 5. Enter the new password (ten characters max).
- The new password is accepted by the transmitter and saves all transmitter settings.



Important Note

Only give the password to authorised persons!

If you write down the password, keep it in a safe place.

If the password is lost, contact NIVUS GmbH.

38 Parameter Functions

38.1 Main Menu

The transmitter is parameterised via the total of six or nine (only for NivuFlow 750 Type M9) setting menus on the first menu level. The individual menus and submenus are explained in greater detail starting with Chapter "39 Parameter Description".

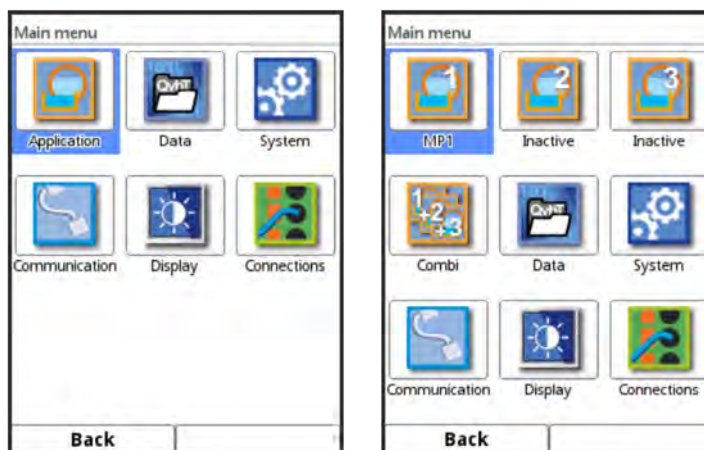

Fig. 38-1 Overview Main Menu

➡ When setting parameters observe Chapter "28 Operation Basics".

38.2 Functions of the first Menu Level

38.2.1 Menu - Application

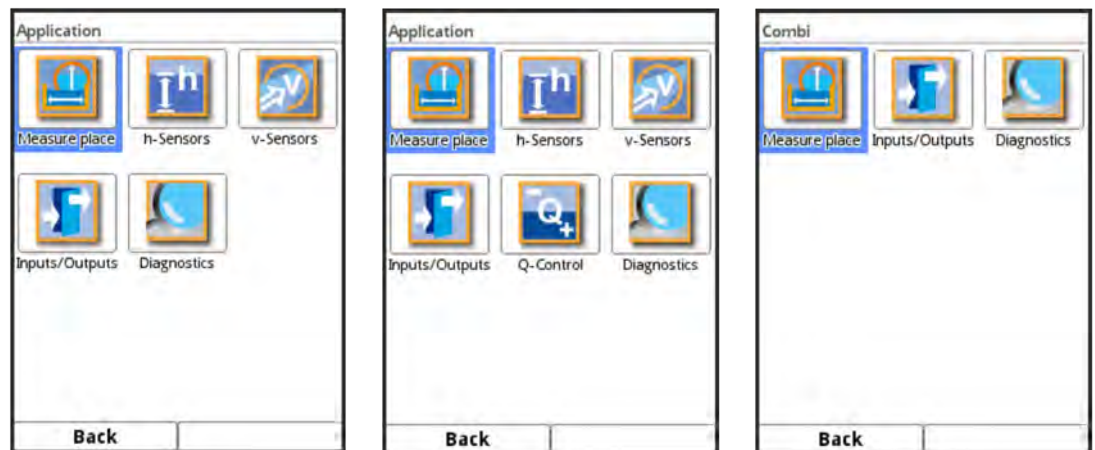

Fig. 38-2 Menu - Application

This menu is the most comprehensive and important within the parameterisation of the transmitter. The >Application< menu contains up to six submenus, depending on the device version/equipment. The shape and dimensions of the measurement place(s) are parameterised here. The level and flow velocity sensors used are defined and the data for their mounting position is parameterised.

You also define the required analogue and digital inputs and outputs here:

- Functions
- Measurement Ranges
- Measurement Spans
- Limit Values
- Error Messages
- Actuator Controls if required

The parameters of the Q-Controller are set under >Application<. The Q-Controller is available with NivuFlow 750 Types SR, M3 and M9.

In the >Application< menu there are diagnostic options available for:

- Sensors
- Inputs and outputs
- Overall system
- Flow profile (display of the measured flow velocity profile in different 3D views)
- Simulation (of velocities and inputs and outputs to verify the function of the overall system)



The diagnostic functions are explained in chapter "Diagnostics" starting at page 179.

The following can be specified or changed in the >Application< menu:

- Constant, fixed sludge levels
- Low-flow suppression
- Damping of signal evaluation and output
- Stability of signal evaluation and output

38.2.2 Menu - Data

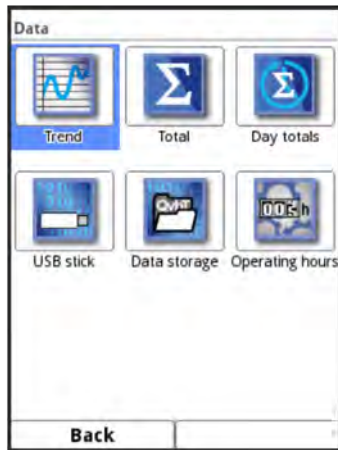

Fig. 38-3 Menu - Data

The >Data< menu allows access to all internally saved measurement values.

The following functions are available:

- Graphic representation of the measurement values
- Listing of the last 100 24h day totals and operating hours
- Listing of all totals (resettable and non-resettable positive, negative and grand totals)
- Communication and transmission options of internal files
- Loading and saving parameters
- Formatting the external USB stick
- Transfer of set parameters from and to USB stick
- Setting and deleting options of the internal data memory
- Setting the storage cycle

38.2.3 Menu - System

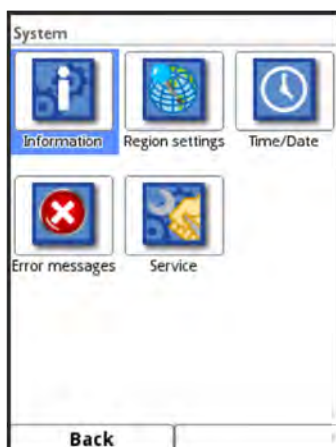

Fig. 38-4 Menu - System

The >System< menu contains information on the transmitter:

- Article Number
- Firmware Version
- Serial Number

- MAC Address
- Licence Conditions (Credits/Licences)

In addition, the following settings/corrections are possible:

- Set Language
- Set units (for measurements or storage, unit system, decimal separator)
- Set/correct date and time (system time, time zone, time server)
- Read active error messages
- Delete error memory
- Change Password
- Restart (system or measurement)
- Parameter Reset
- Update of transmitters and sensors (in service level; only in consultation with NIVUS)

38.2.4 Menu - Communication

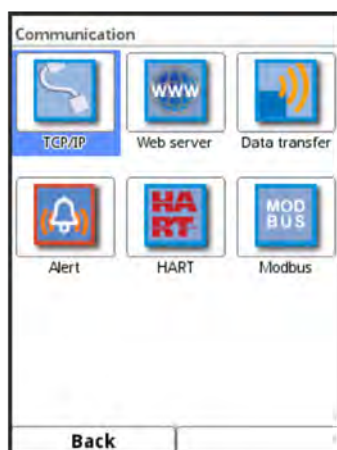

Fig. 38-5 Menu - Communication

This menu includes the setting options of various communication interfaces with other communication systems:

- TCP/IP
- Web Server
- Data Transmission
- Message Alert Settings
- HART
- Modbus

38.2.5 Menu - Display

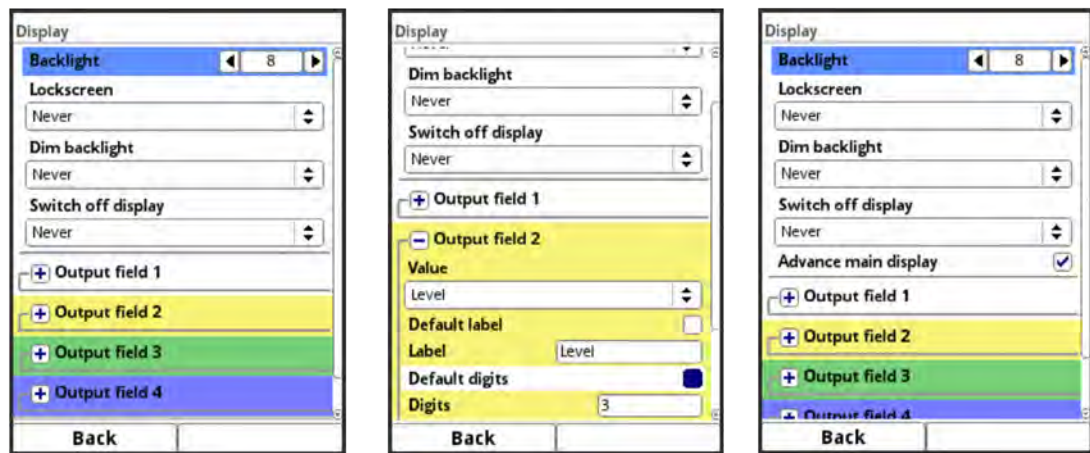

Fig. 38-6 Menu - Display

In this menu, adjustments are made to the background lighting, any corrections to the five output fields of the main display are set if necessary, and (de)activation of the main display (for multiple measuring points with NivuFlow 750 Type M9) is set.

38.2.6 Menu - Connections

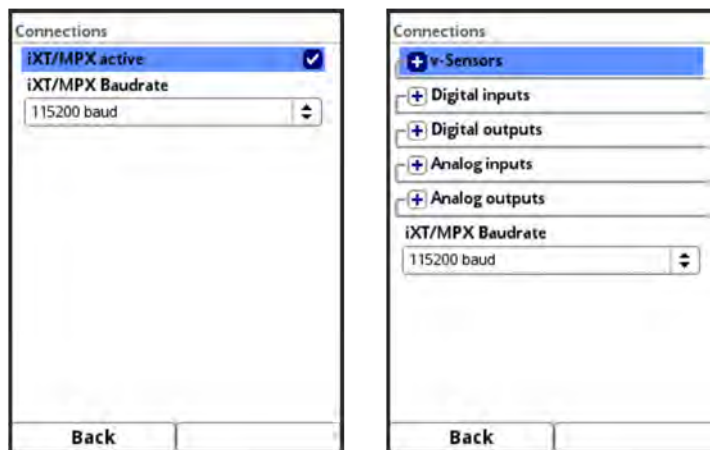

Fig. 38-7 Menu - Connections

The connection of an intelligent iXT Ex Separation Module or a multiplexer to the transmitter must be entered here.

In addition, for the NivuFlow 750 type M9 with multiple measurement places, the connections of the sensors and the inputs/outputs are selected and assigned to the individual measurement places.

39 Parameter Description

39.1 Setting the Measurement Place Parameters (Menu Application)

The submenu >Measurement Place< is one of the most important basic menus in the parameterisation.

The parameter settings of the measurement place include basic settings:

- Name of the measurement place
- Type and dimensions of the channel profile
- Possibly fixed settings for sediments

- Low-flow suppression
- Damping and stability of the measurement
- With the NivuFlow 750 Type M9, several measurement places can optionally be created and individually set active/inactive.

39.1.1 Active/Activation of Measurement Places (only for NivuFlow 750 Type M9 with multiple Measurement Places)

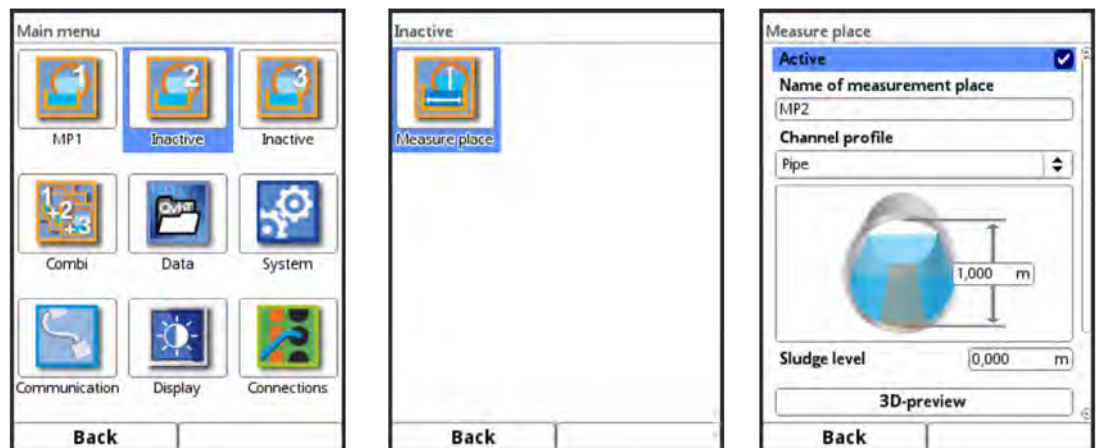

Fig. 39-1 Measurement Place inactive/active

This option is only available with NivuFlow 750 Type M9 (with multiple measurement places), as it is directly related to the transmitter's capability to handle multiple measurement places. Checking the box activates measurement place 2/3. If the box is not checked, the measuring point is inactive, nothing is displayed and its parameters cannot be set.

39.1.2 Name of the measurement place

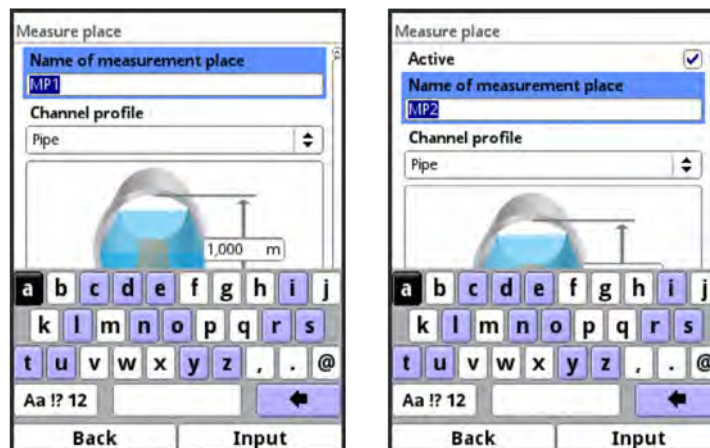

Fig. 39-2 Specifying the Name of the Measurement Place

The desired measurement place name is entered here. The input is limited to 256 characters.

Default setting of the measurement place name: NIVUS1.

When resetting the measurement place name, the default name is automatically deleted after the first letter or number is selected.

➡ Procedure:

1. Use the keypad to enter the measurement place name completely into the text field (see Chap. "28.3 Use/Entry using the letter block").
2. Confirm the measurement place name with the right function key "Input".

The measurement place name is transferred to the main menu and displayed there.

39.1.3 Channel Profiles

The transmitter allows the selection of a variety of standardised channel profiles that are predominantly used in practice.

Since older sewer systems in particular often have special designs, the transmitter also offers the option of entering symmetrical and asymmetrical flumes in their dimensions or height/area in the form of a table.

The selected profile is displayed graphically when the 3D preview field is selected. The entered measurements are set in relation to each other in the graphical representation.

This visual check can immediately determine whether the profile has been laid out correctly in principle. Especially with free profiles, this direct control is helpful.



Fig. 39-3 Selectable Channel Profiles

- Select from the available channel profiles:
 - Pipe
 - Ellipse
 - Egg Profile (1:1.5)
 - Rectangle
 - U-Profile
 - Trapezoid
 - Water Bed
 - Height-Width (symmetric)
 - Height-Width (asymmetric)
 - Height-Area
 - $Q=f(h)$
- After selecting the profile, enter the values of the dimensions digit by digit. Pay attention to the unit of measurement (decimal point).
Default setting: channel profile dimensions in METER.

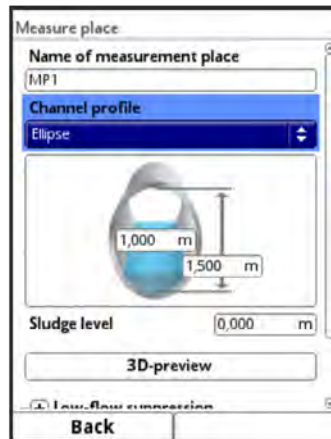

Fig. 39-4 Example of a channel profile menu

Pipe

This selected shape is suitable for round pipes. This shape selection can also be used for half shells with a maximum filling level of 50 %.

Deformed pipes with asymmetrical height/width ratio can be parameterised via the channel profiles Ellipse or Height-Width (sym.) or Height-Width (asym.).

A separate profile selection is created for U-profiles.

Ellipse

The elliptical profile is mainly used for pipes subject to high mechanical loads (lateral pressure or crest pressure). Special channel shapes are also known as elliptical profiles.



Note

Do not confuse the horizontally and vertically symmetrical ellipse profile with the egg profile. Egg profiles have different radii in bottom and crest and are therefore only vertically symmetrical.

- ➡ Enter both dimensions of the elliptical profile.

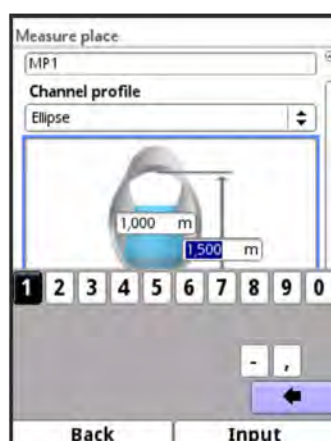

Fig. 39-5 Setting Parameters for the Elliptical Profile

Egg Profile (1:1.5)

This channel is a "standard egg" according to DWA A 110 with a width/height ratio of 1:1.5. Pressed or compressed egg profiles must be parameterised using a free profile.

When setting the parameters for a "standard egg" egg profile, only the maximum channel width is entered. The transmitter automatically calculates the height using the specified 1:1.5 ratio.

Rectangle

With this profile selection, channels with vertical walls and horizontal bottom are parameterised. By simply entering the channel width and height, the parameters are quickly set.

This menu also includes the option to set parameters for a channel with a central dry weather flume in semicircular or U-profile form.

- **Rectangle with Dry Weather Flume**

➡ Procedure:

1. Select dry weather flume.
2. Check the >Active< box.
3. Two more input fields open up.
4. Enter height and diameter of the dry weather flume.
5. Check the input of the dimensions using the 3D display.

U-Profile

The U-profile consists of a semicircle at the bottom and vertical walls. The semicircle radius here is 0.5x the channel width. It is entered independently by the system in the calculation.

For profiles with radii > 0.5x the channel width use the free profile option.

Trapezoid

With this profile selection, it is possible to parameterise symmetrical channels with a horizontal bottom and sloping side walls.

Symmetrical channels with a horizontal bottom, sloping side walls and attached vertical walls are also parameterised via this profile setting.

Trapezoidal profiles with sloping base must be parameterised via the "free asymmetric profile with height-width" (see page 96).

This menu also includes the option to set parameters for a channel with a central dry weather flume in semicircular or U-profile form.



Fig. 39-6 Setting Parameters for the Trapezoidal Profile

- **Trapeze with Dry Weather Flume**

➡ Proceed as described in the rectangle with dry weather flume section on page 94.

Water Bed



Note

The parameterisation of a water bed requires extensive knowledge and experience with the functions of the NivuFlow 750/700 as well as the hydrological boundary conditions.

We recommend that the parameterisation be carried out by the NIVUS commissioning service or a specialist company authorised by NIVUS.

This type of channel is mainly used for applications in near-natural channels with rainwater or greywater.

With this profile, you define the reference point/zero point yourself. Usually, the maximum filling level or the water surface on a bank or channel side is defined as the zero point. Here, the watercourse profile for a specific watercourse section can be stored in the transmitter by means of local measurements.

- Enter the freely defined measurement sections in height and width, referred to the defined zero point, one after the other into the table.

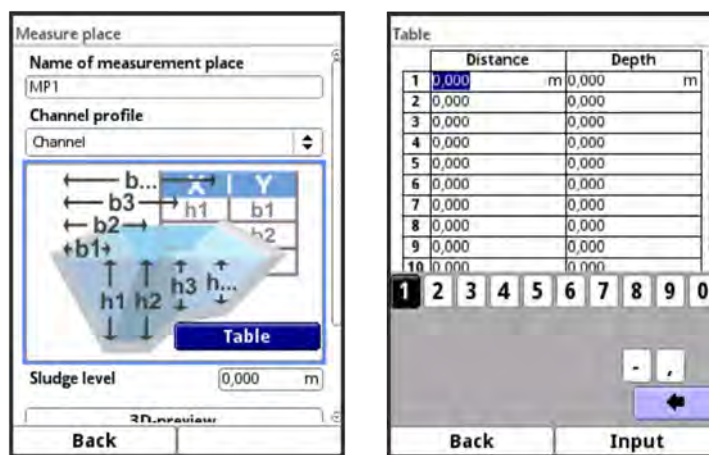

Fig. 39-7 Setting Parameters for the Water Bed Profile

Symmetrical profile with Height-Width (Height-Width (sym.))

Any symmetrical profiles can be set in this menu.

After selecting >Table< a table of values appears. A maximum of 32 breakpoint pairs (channel height/channel width) can be entered in this table. These values are automatically calculated in the system and stored internally as a symmetrical profile.

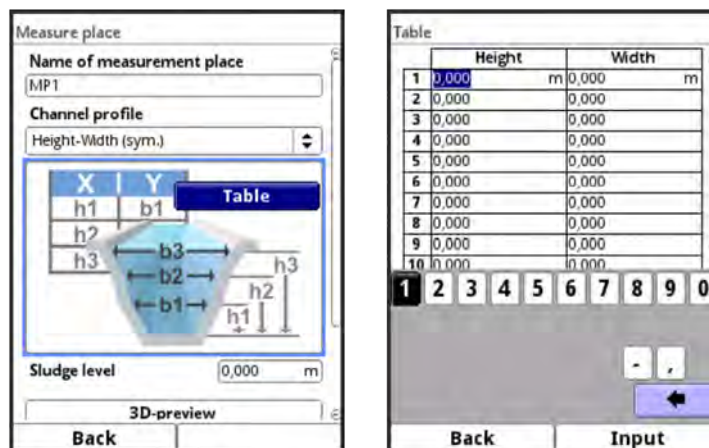

Fig. 39-8 Setting Parameters for the Height-Width (sym.) Profile



Note

A drawing to scale or a dimensioned sketch is required for the parameterisation of the channel.

➤ Procedure:

1. Draw a vertical guide line in the centre of the channel on the scaled drawing.
2. Draw horizontal guide lines at the prominent profile change points.
3. Measure the length of these guide lines and then convert them to scale.
4. Start at height "0" to define a channel start.
5. Enter all other breakpoints "free" in height and width.
The distance between the individual height points can be variable. For the profile definition, it is not necessary to specify all 32 breakpoints. The transmitter linearises between the individual breakpoints.
In the case of large uneven changes in the channel dimensions, select a smaller breakpoint distance in this change range.
After the channel parameterisation has been completed, the entered values are displayed graphically in proportion to each other.
6. Check the input of the dimensions using the 3D display. This visual control option makes any gross parameterisation errors visible.

Free asymmetric Profile with Height-Width (Height-Width (asym.))

In practice, asymmetrical profiles occasionally appear in unusual shapes. The parameterisation option for asymmetric profiles is used for this.



Important note on the viewing direction for free profiles

The viewing direction >Width left< or >Width right< is opposite to the flow direction in the channel (see step 4 on page 97).

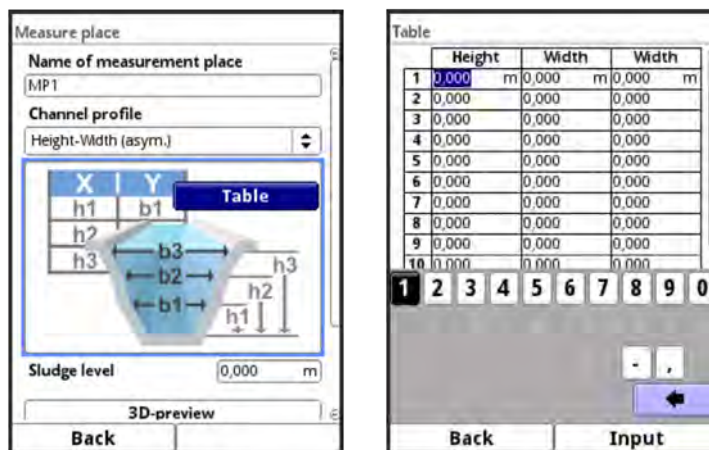

Fig. 39-9 Setting Parameters for the Height-Width (asym.) Profile



Note

A drawing to scale or a dimensioned sketch is required for the parameterisation of the channel.

➡ Procedure:

1. Draw a vertical guide from the lowest channel point upwards on the scaled drawing.
2. From this guide line, draw horizontal guides to the left and right at the prominent profile change points.
3. Measure the distances of these guide lines from the centre guide line to the right and left respectively.
4. Enter the breakpoints, converted to scale, in the 3-column value table as follows:
Height / Width to the left / Width to the right.
Here, **observe** the previously mentioned important note on the **viewing direction** for free profiles on page 96.
5. Start at height "0" to define a channel start.
6. Enter all other breakpoints "free". A maximum of 32 breakpoints can be specified. The distance between the individual height points can be variable. For the profile definition, it is not necessary to specify all 32 breakpoints. The transmitter linearises between the individual breakpoints.
In the case of large uneven changes in the channel dimensions, select a smaller breakpoint distance in this change range.
After the channel parameterisation has been completed, the entered values are displayed graphically in proportion to each other.
7. Check the input of the dimensions using the 3D display. This visual control option makes any gross parameterisation errors visible.

Free symmetrical profile with Height-Area (Height-Area)

Some hydraulic tables contain the value pairs Height-Area instead of Height-Width for symmetrical channels. In this case, enter the value pairs in the selected Height-Area table.

Here, **observe** the previously mentioned important note on the **viewing direction** for free profiles on page 96.

The rest of the procedure is identical to the parameterisation of the Height-Width profile. Only a graphic representation of the parameterised profile is not possible here.

Q/h-Function ($Q=f(h)$)

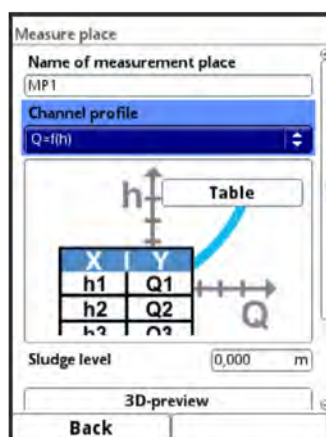

Fig. 39-10 Q/h-Function

This function differs significantly from the previously described channel profiles. When selected, neither the channel profile nor the flow velocity are taken into account. **Communication** with any connected flow velocity sensors is **switched off**. Therefore, the missing flow velocity value is not taken into account in any error diagnosis.

The system operates a pure Q/h function. This means that a defined flow rate value is dis-

played depending on the currently measured level. This value to be displayed is entered height-related in a value table.

A maximum of 32 height-related breakpoints can be specified in this table. The transmitter linearises between the individual breakpoints.

39.1.4 Sludge Level

In horizontal pipes and channels, depending on the measured medium, dirt load, grain size and flow velocity, deposits (sediments) may occur at the bottom.

In this parameter, a fixed sediment height (deposition) can be entered as >Sludge Level<. The entered sludge level is calculated as the "non-moving, bottom lying partial area of the channel with a horizontal surface". This height is subtracted from the total wetted hydraulic area before the flow calculation.

39.1.5 3D Preview

If the 3D preview is selected, the parameterised measurement place with the respective sensors can be displayed with matching relations (depending on the accuracy of the parameter settings).

This function allows an immediate visual check of the plausibility of the parameterisation when setting the parameters of complex profiles, free profiles and water beds etc.

39.1.6 Low-flow suppression

This parameter is used to suppress the slightest movements or apparent quantities. The main field of application for this parameter is the measurement of flow rates in structures that are permanently dammed from the receiving water.

- ☞ Check the >Active< box.
Another input option opens. Enter here which absolute value is to be suppressed, e.g. for lowest discharge rates. It is not possible to specify negative values.

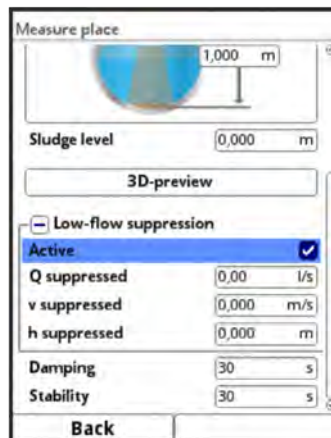

Fig. 39-11 Low-flow suppression

Low-flow suppression prevents the detection of the slightest changes in velocity. These changes can cause large apparent fluctuations in the measured volume over a longer period of time.

Application Example:

Slushing movement of a river into which a permanently dammed overflow channel flows.

Flow velocities that are smaller than this parameterised value are "suppressed". This means that no quantity is recorded and the transmitter does not store a value.

>Q suppressed<

- Specify the flow value to be suppressed. It is not possible to specify negative values. The entered value is interpreted as an absolute value and has both a positive and negative effect.

If the current, calculated measurement values are smaller than this entered value, the system automatically sets the measurement values to "0".

>v suppressed<

Low-flow volumes can be suppressed here for applications in large profiles and with high filling levels. The slightest changes in velocity can cause large apparent changes in volume over a longer period of time, which cannot be suppressed using the value >Q suppressed<. If the flow velocities are lower than this parameterised value, the system automatically sets the measurement values to "0".

This also makes the calculated volume "0".

Only a positive value can be specified. The entered value is interpreted as an absolute value and is effective for both positive and negative velocities.

>h suppressed<

Lower limit values for fill levels can be entered here. If the real levels are smaller than this entered value, the system automatically sets the measurement values to "0". This means that no area is calculated and no volume calculation can be carried out.

Instructions for use:

This parameter is mainly used when working with a pressure measuring cell in the lower level measuring range up to around 0 and the volume is simultaneously recorded in the last centimetres of the application using a Q/h relation. Pressure probes tend to zero point drift. Applications with completely empty channels could thus calculate a very low flow rate due to the low 0-point drift and the parameterised Q/h relation, which is reflected in an incorrect total flow rate over a longer period of time.

39.1.7 Damping

This menu point allows you to change the damping of the display and analogue output in seconds.

The damping refers to all level and flow velocity values that are available as input values. Individual values cannot be selected and damped differently.

All measurement values are stored over the specified time range and a moving average is calculated for each individual measurement value. This average value is used for further calculation of the flow rate.

The time range is entered in steps of 1 second.

Default setting: 30 s

39.1.8 Stability

The stability is the time in which the transmitter without valid (i.e. invalid) level and/or flow velocity values still displays a measurement value.

In this case, invalid means "not plausible" or "illogical". This evaluation is carried out by the flow velocity sensors POA, CS2 and EBM and the water ultrasonic level sensor integrated in the POA or CS2 as well as by the air ultrasonic sensor OCL and passed on to the transmitter as invalid. If the transmitter detects this invalid information, it operates with the last valid measured value for the parameterised stability time.

If the specified time is exceeded without a correct value being recorded, the transmitter goes to the measured value "0", taking into account the set damping.

Instructions for use:

This parameter is used

- in applications with a turbulent and wavy water surface and the use of a water-ultrasonic or a type OCL air-ultrasonic sensor:
Here, a temporary reflection of the ultrasonic signal can occur; i.e. the ultrasonic signal is deflected by a wavy water surface so that the reflected signal does not return to the sensor.
- in applications with very few reflective particles (scatterers) in the medium:
These can make the evaluation of the flow velocity difficult due to many invalid velocity measurements and an intermittent 0 display of the velocity.

The time range is entered in steps of 1 second.

Default setting: 30 s



Note on Stability

Extended stability makes the measurement less sensitive to short-term disturbances.



Note on Sensor Errors

Sensor errors such as falling below the 4 mA limit with 2-wire sensors are output immediately without delay.

39.2 Setting Parameters in Menu h-Sensors

After setting the measurement place parameters, the level sensor(s) used must be defined and their operating ranges set in the submenu >h-sensors<.

39.2.1 h-Sensor Types



Fig. 39-12 Selecting the h-Sensor Types

A selection of level sensors can be found in the >h-Sensor Types< field.

- Open the >h-Sensor Types< parameter.
- Select the sensor type(s) connected to the transmitter.
In the vast majority of applications, it is sufficient to select a level sensor. When using several level sensors (e.g. i-Sensor and 2-wire level), set a tick for each sensor.

Info:

The number and types of level sensors required are determined when planning the measurement place. For example, it may be physically necessary to detect low and medium

levels with the required high accuracy using an air-ultrasonic sensor. In case of full filling and when the air-ultrasonic sensor is flooded, the measurement then switches to pressure measurement.

Note:

Before parameterisation, get information about the planned level measurements and the required working ranges of the different sensors in the application.



Note

A selected sensor that is not physically connected cannot be generated by the transmitter. After completing the parameterisation, the transmitter detects the missing or incorrectly selected sensor and issues an error message.

The number of selected sensors corresponds to the number of individual level measurement ranges over the entire measurement cross-section. Only one level sensor per measurement can provide the valid value for the measurement. Incorrect combinations and combinations that do not make sense are not accepted by the transmitter.

A maximum of three different level sensors can be selected.

The sensor measurement ranges can be set below the channel graphic.



Transmitter does not recognise which type of sensor the 2-wire level sensor is

The representation of the sensor in the display is not decisive for the measurement range. As standard, the transmitter displays the 2-wire level sensor as an ultrasonic sensor from above.

Example

Air ultrasound sensor at the top with sound direction downwards; pressure sensor and water ultrasound on the bottom of the channel.

The level sensors are displayed in the channel shape that was previously parameterised under the measurement place.

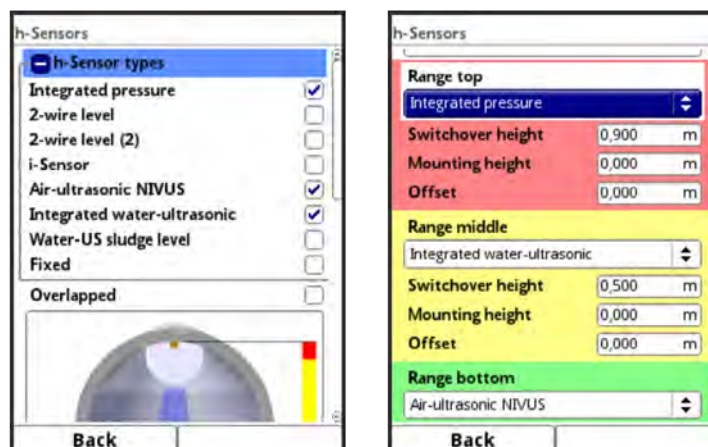

Fig. 39-13 Selecting the Level Sensors

The following level sensors are available:

- Integrated Pressure**
 The level is measured from below using a combi sensor with integrated pressure measurement cell (Type V2D or V2U).
 Side mounting, e.g. in case of sedimentation or high dirt load, is possible.
 The Level measurement in overflow conditions is possible too.
- Integrated Pressure (2) / (3)**
 Second and third combi sensor with integrated pressure measurement cell available.

- **2-wire Level**
The level is measured via an external 2-wire sensor which is supplied by the transmitter.
Example: pressure probe Type NivuBar Plus or compact echo sounder Type NivuCompact.
The use of a 0/4...20 mA signal from an external transmitter such as NivuMaster or MultiRanger is also activated via this selection.
- **2-wire Level (2)**
Second external 2-wire sensor available.
- **i-Sensor**
Here the NIVUS ultrasonic i-Series sensor is connected. The connection is made via the HART interface.
- **Air-Ultrasonic NIVUS**
The level is measured from above via an air-ultrasonic sensor Type OCL-L1 or DSM-L0. These sensors are used for the measurement of low levels. The level sensor must be installed exactly in the middle of the channel crown, ($\pm 2^\circ$) parallel to the water surface.
- **Integrated Water-Ultrasonic**
The level is measured from below using a combi sensor Type POA-V2H, POA-V2U, CS2-V2H or CS2-V2U by water ultrasound. This sensor type is used to detect the discharges in the medium part filled area. The combi sensor must be installed exactly in the centre of the channel bottom ($\pm 2^\circ$). If there is a risk of sedimentation or sludge deposits, the sensor can be placed off-centre. In this case, the water ultrasound from below must **not** be used! The measurement may fail.
Select a different level sensor (ultrasound from above or pressure measurement cell) for this case.
- **Water-US Sludge Level**
The water-US sludge level sensor is only listed in the selection if the >Float< was previously selected in the >v-Sensors< menu.
With this sensor, sedimentation levels can be determined if the measurement technology is suitable. This selection is only possible in combination with another height measurement for partial filling or for full filling (i-Sensor, 2-wire sensor or NIVUS air-ultrasonic sensor).
A combi sensor Type POA-V2H or CS2-V2H with water ultrasound **from above** is used for this purpose.
This combi sensor is either permanently installed (e.g. for full filling via fixed setting) or attached via a float for partial filling.
See also Fig. 39-13.
- **Fixed Value**
This selection is intended for permanently full pipes and channels. No level measurement is required for these applications. The constant level is given to the measurement system and used for flow calculation.
This parameter can also be used as a support for the initial commissioning or for tests without an available level value.

39.2.2 Definition of Measurement Ranges

Depending on the type and number of selected sensors, a vertical coloured bar appears on the right side of the displayed channel profile. With this bar, the working range of the individual sensors is marked in the corresponding colour section.

- Measurement Range
 - Top: red
 - Centre: yellow

- Bottom: green
- Number of sensors used
 - only one: solid green bar
 - two: colour combination green/red
 - three: colour combination green/yellow/red

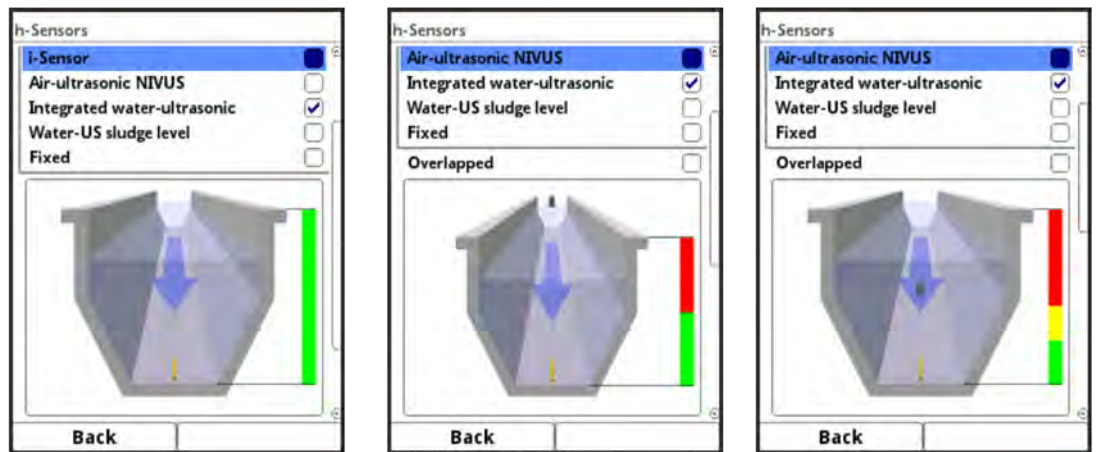

Fig. 39-14 Selecting Sensors and Display of Sensor measurement Ranges

Depending on the type and number of selected sensors, one to three coloured parameterisation areas are displayed below the channel display. The colour of these parameterisation areas corresponds to the colour of the vertical bar (as described before) and the assigned sensors.

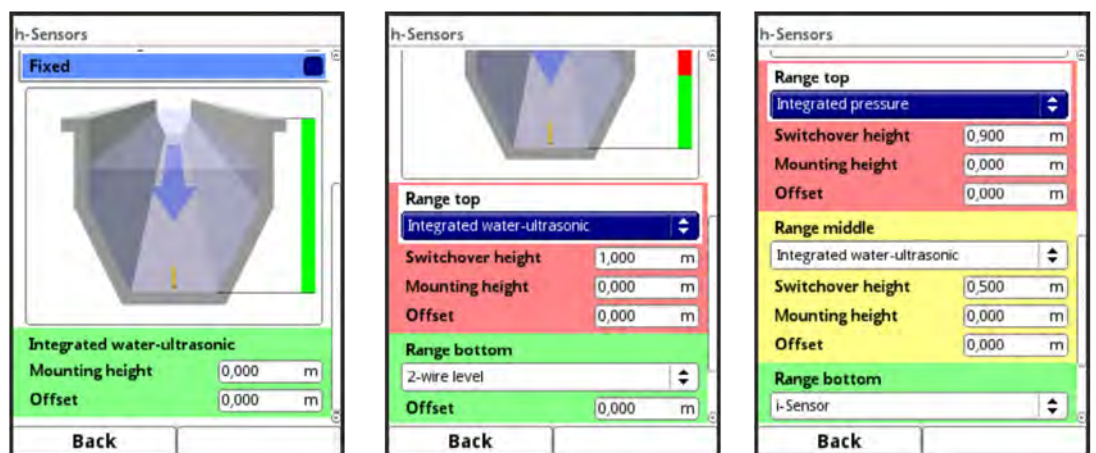

Fig. 39-15 Representation of the Parameterisation Ranges

The transmitter automatically assigns the sensors to the appropriate parameterisation range. The assignment depends on the parameterised channel shape.

- Air-Ultrasonic: measurement range bottom
- Pressure Measurement Cell: measurement range top
- etc.

This assignment can be changed as desired. When selecting the assignment, only those sensors are displayed that were previously selected. (see Fig. 39-13).

A level sensor can also be used for two or three parameterisation ranges. In this case, the other activated level measurement values are only stored internally but are not used for calculation.



Fig. 39-16 Assignment Level Sensor to Parameterisation Range

Each parameterisation range can be changed in its range size. Make this change of range by changing the according >Switchover Height<.



Important Note

Make sure that the values of the positioning of the individual sensors must be specified precisely.

Sensors with integrated pressure measurement cell must be placed at the lowest point of the channel bottom (sensor Types POA-V2D, POA-V2U, CS2-V2D, CS2-V2U and CSM-V1D).

For sensors that are mounted on an elevation (block or similar) or on a berm, a value other than "0" must be entered for the mounting height. Measure the distance from the **lower edge** of the sensor mounting plate to the lowest point of the application and enter this value as "Mounting Height".

For sensors mounted at an angle (e.g. when mounted laterally in a pipe or trapezoidal channel), the **centre** of the sensor mounting plate is the reference value.

The value of the sensor positioning is automatically adopted for the position of the v-sensor as well as for the determination at v-crit.(see Chapter "39.3.5 v-Determination low Levels").

An additional offset can be entered to adjust the pressure sensors.

Enter values by using the displayed keypad (according to Chapter "28.3 Use/Entry using the letter block").



Fig. 39-17 Setting Parameters of the integrated Pressure Sensor

The same specifications apply to flow velocity sensors with integrated water-ultrasonic sensor. Measure the distance from the top edge of the sonic converters (light grey or white circular plastic surface).

The sensor height is different for the POA and CS2 sensors due to their design. These differences are automatically recognised by the system when the sensor is connected and taken into account accordingly.



Important Note

When using an i-sensor (connection via the HART interface), be sure to specify the sensor type correctly. The transmitter automatically takes over the sensor-specific data.

Check the iXT box in the i-Sensor selection menu if the i-Sensor is connected via the HART interface of an iXT.

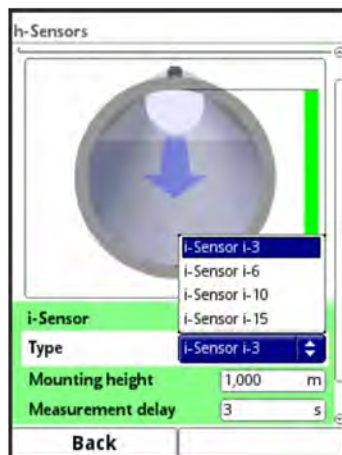

Fig. 39-18 Setting Parameters i-Sensor-Type



Important Note

If the i-sensor is connected via an Ex Separation Module Type iXT, the use of an iXT must be activated in the main menu/connections before setting the sensor type parameters.

Without activation, the selection of the connection in the >h-Sensors< menu is not visible.

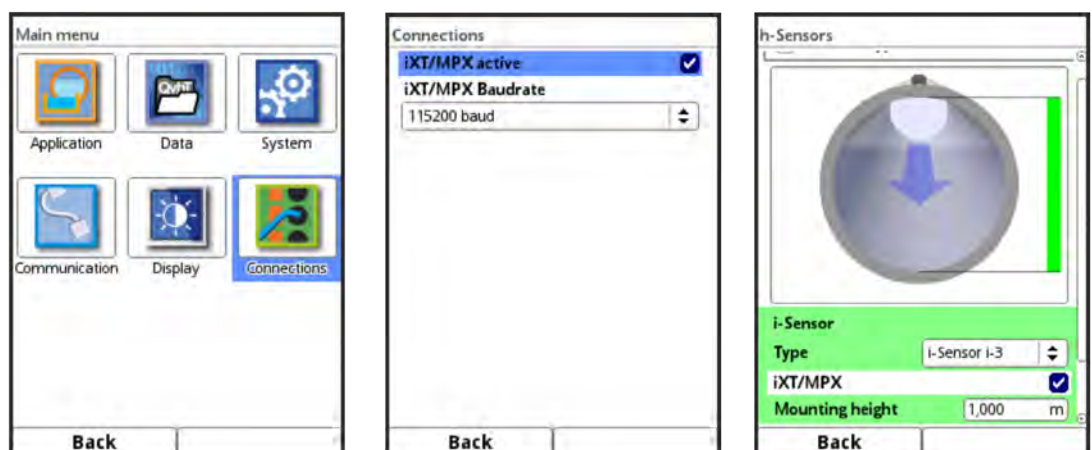

Fig. 39-19 Activation HART Interface in iXT

The specification of the mounting height of the i-sensor refers to the lower edge of the sensor to the zero point of the channel. This value defines the zero point of the measurement. The accuracy of the parameterisation of this value has a direct influence on the accuracy of the level measurement by means of the i-Sensor.

Use of two or more Level Sensors with Overlap

This variant is selected, for example, if an overflow of the level sensor is to be expected, as in the following example with a pipe measuring section with attached dome.

In **section 1**, a 2-wire pressure probe is installed on the bottom of the pipe measuring section with a measuring span of 0...1 m. The pressure probe is defined as "2-wire Level (2)".

The pressure probe should measure the level in the range between 0 and max. 0.35 m. A second sensor is used for the section above.

In **section 2**, an i-Series sensor (above the water surface) is mounted above the channel. This sensor is to be added from a fill level of 0.32 m and detect the range up to full filling.

Due to this arrangement and parameterisation, the two measurements work overlapping in a range of 0.03 m (see also Chap. "39.2.3 Overlapping").

Procedure:

1. Sensor 1 (2-wire pressure probe):
Enter measurement range for level measurement (height min. / max.), set offset to "0.0 m" (4 mA) and measurement span to "1.0 m".
2. Sensor 2 (i-Series sensor):
Enter measurement range (height min. / max.), select sensor type and enter mounting height.
3. Verify the settings against the graphic above.

39.2.3 Overlapping

This parameter is only visible/selectable if more than one level sensor has been selected.

By including the individual measurements of a second sensor in the calculations of the transmitter, it is possible to create redundancy between the height measurements (basically as a mutual check) as well as to achieve an averaging of the measured heights.

This overlap is indicated in the graphic by offset colour bars next to the channel (Fig. 39-20).

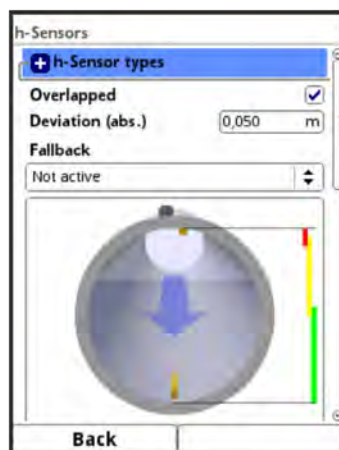

Fig. 39-20 Selection and Display of the Overlap

39.2.4 Deviation (abs.)

The >Deviation (abs.)< is only visible/selectable if at least two level sensors are connected and the overlap is activated.

The value entered here defines the allowed absolute deviation from the median ¹ of the height measurements to determine if the measurement is valid.

If measurement values of one or more sensors are outside the validity range, the individual measurements are invalid and are not included by the transmitter. In addition, an error message is generated and stored in the error memory.

The measurements continue nevertheless and are checked for validity by the transmitter. As soon as there are measurements within this range again, they are also included in the calculations again and the error message is no longer active.

***1) Determining the Median:**

The measurement values of the sensors within the overlapping measurement ranges are compared and a so-called median is determined:

- with two sensors, this is the mean value of the two measurement values (= measurement value mean), i.e.
 - Sensor 1: 0.9 m
Sensor 2: 1.0 m
 - results in a median of 0.95 m
- with three sensors, the measured value of the middle sensor (= middle measured value), i.e.
 - Example I:
Sensor 1: 0.9 m
Sensor 2: 1.0 m
Sensor 3: 0.92 m
 - results in a median of 0.92 m (measurement value of the middle sensor)
 - Example II:
Sensor 1: 0.9 m
Sensor 2: 1.0 m
Sensor 3: 1.0 m
 - results in a median of 1.0 m (measurement value of the middle sensor)

39.2.5 Fallback

The fallback sensor is always used when no level sensor is operating within its parameterised detection range and within the defined median deviation. This is done independently of the detection range parameterised for the fallback sensor.

39.3 Setting Parameters in Menu v-Sensors

The third important point, in addition to the measurement point and the level sensors, is the parameterisation of the flow velocity sensors. In addition to type and number of sensors, this menu also includes the spatial position. Information in this menu item refers to the defined channel in terms of shape as well as spatial dimension (see Chapter "39.1.3 Channel Profiles").



Note

In contrast to the usual way of looking at it, the user looks with the flow direction, the v-sensors point in the direction of the user.

When setting the parameters, observe that the real installation is rotated by 180°.

39.3.1 Number of Flow Velocity Sensors

A NivuFlow 750/700 transmitter provides the possibility to connect one or more flow velocity sensors.

The number of sensors that can be connected depends on the type of transmitter:

- Type S1 - one flow velocity sensor
- Type SR - one flow velocity sensor
- Type M3 - up to three flow velocity sensors
- Type M9 - up to nine flow velocity sensors



Fig. 39-21 Selection Menu Flow Velocity Sensors

➤ Procedure to select the further sensors:

1. Open the menu >v-Sensors<.

A selection field with the numbers 1...x is shown at the top right of the display. This selection field shows which connected flow velocity sensor is/can currently be displayed and parameterised.

Default Setting: v-Sensor 1 activated as first sensor.
2. Press the right function key (Tab) to switch to v-sensor 2.
3. Check the >Active< box to set the parameters of the activated sensor. The activated sensor is directly visible in the application graphic.

The sensor that is currently being parameterised is marked in colour in the graphic. The remaining sensors present are shown in their outlines at the same time.

39.3.2 Sensor Types

You can select a total of five different sensor types:

- Wedge (POA and CS2 sensors)
- Pipe (POA and CS2 sensors)
- Float
- EBM without pressure (connection of a CSM-V100 wedge sensor via the EBM Electronic Box)
- EBM with pressure (connection of a CSM-V1D0 wedge sensor via the EBM Electronic Box)

The selected design >Wedge< or >Pipe< is visible in the graphic.

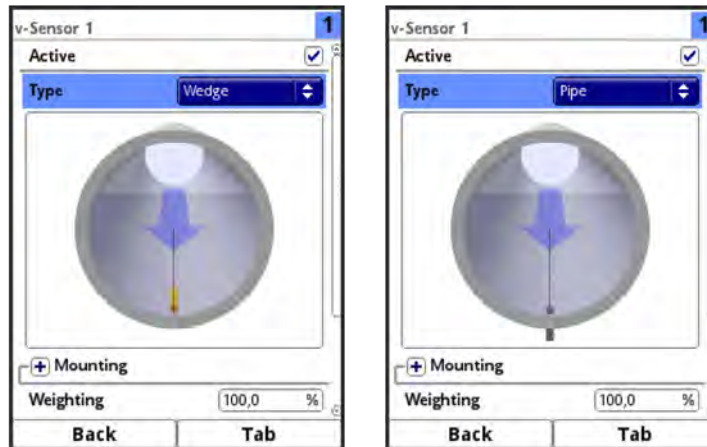

Fig. 39-22 Representation Wedge or Pipe Sensor

39.3.3 Mounting Position of Sensors



Note

In contrast to the usual way of looking at it, the user looks with the flow direction, the v-sensors point in the direction of the user.

When setting the parameters, observe that the real installation is rotated by 180°.

For mounting the v-sensors, additional parameters can be entered for the application. These specifications are intended for installation positions that deviate from the factory setting. This applies in particular to installations on wedges or similar or lateral installations in pipes and U-profiles where there is a risk of sedimentation.

Procedure:

1. Rotate the rotary pushbutton until the field >Mounting< is highlighted blue.
2. Press the rotary pushbutton - the PLUS at the front turns to MINUS. An input menu opens.

Selection Flush with Wall (possible only with following channel profiles)

- Pipe
- Egg Profile
- U-Profile

If >Flush with wall< is not activated, the three parameters >Mounting Height<, >Distance Centre< and >Mounting Angle< can be entered.

Instructions for use:

Setting the individual parameters is particularly useful if sensors are mounted off-centre in the channel but, for reasons of recording the velocity profile, are to measure vertically upwards over as large a curvature width as possible, and not at right angles to the mounting wall (Fig. 39-23). The setting >Flush with wall< would record the maximum speed several times and take this into account too much in the calculation.

This setting is also preferred when using two or three sensors in structured cross-sections with sloping floors and/or dry weather flumes.

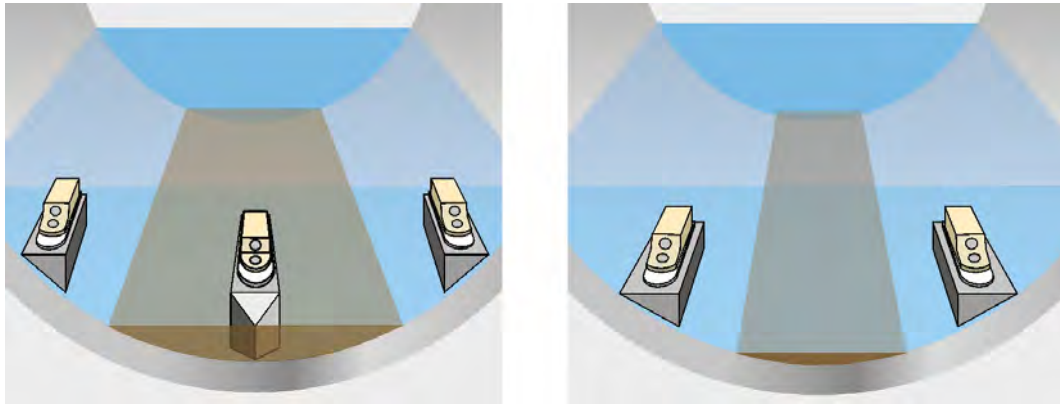

Fig. 39-23 Principle of Sensor Mounting - with Wedge Supports, not flush with Wall

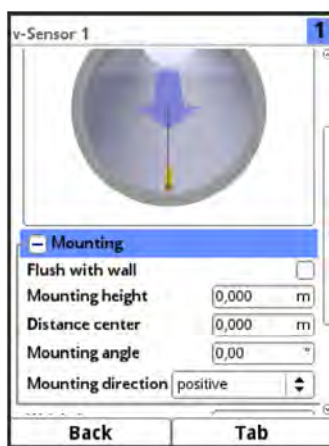

Fig. 39-24 Setting Parameters using Height, Distance and Angle

Alternatively, if the sensors are installed flush with the wall, only enter the beam angle. The entry is made when:

- Wedge sensors are mounted directly on the wall of the inclined/curved surface
- or
- Pipe sensors are inserted at right angles from the outside.

The use of the **1-parameter parameterisation only using the mounting angle** requires a beam angle to the centre of the circular profile/circular section and requires the installation mentioned before. It significantly facilitates the correct setting of parameters.

➡ Procedure:

1. Check the >Flush with wall< selection box.
The following input fields will be reduced. Only the input field >Mounting Angle< is active.
2. Specify the sensor mounting angle.
3. Check input in relation to the position of the sensor in reality. Pay particular attention to the sensor height in relation to the 0-point of the application.
In the graphic, the sensor is displayed in the entered beam angle.

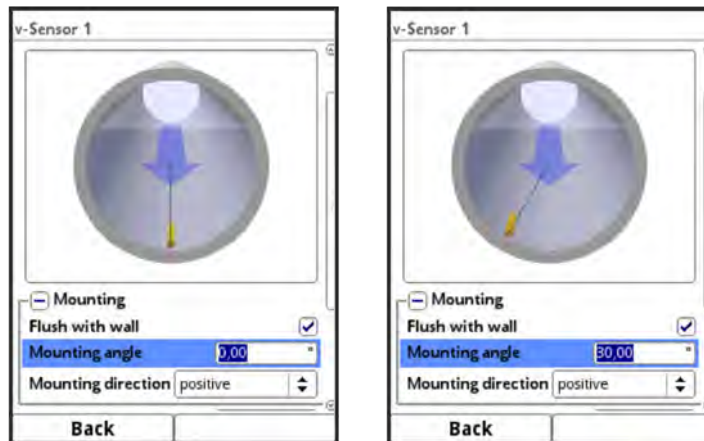

Fig. 39-25 Setting Parameters by Angle Input

Input Field >Mounting Height< (only if >Flush with wall< is not activated/available)

➡ Procedure:

1. Measure the distance from the lower edge of the mounting plate (v-sensor) to the lowest point of the channel bottom.
2. Rotate the rotary pushbutton until the field >Mounting Height< is active.
3. Enter the measured distance.

Default setting: units in METER.

Do not enter a value if the sensor is screwed directly to the floor at the lowest point (or inserted as a pipe sensor from the outside at the lowest point of the application).

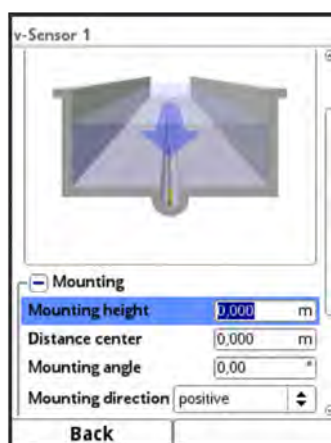

Fig. 39-26 Setting the Mounting height Parameters

In structured channel profiles, e.g. channels with **dry weather flume** and **berm**, the lowest point in the channel corresponds to the zero point. The lowest point in this case is the bottom of the dry weather flume.

If additional sensors are placed directly on the berm, the berm is parameterised as an elevated installation position.

➡ Procedure:

1. For v-sensor 2, enter the elevation of the berm as the mounting height.
2. Check the input of the mounting height in the application graphic. With the help of the application graphic, you can immediately see whether the mounting height of the v-sensors has been entered correctly. In Fig. 39-27 you can

see that the berm was not taken into account in the installation height. The v-sensor is located below the channel bottom in the graphic.

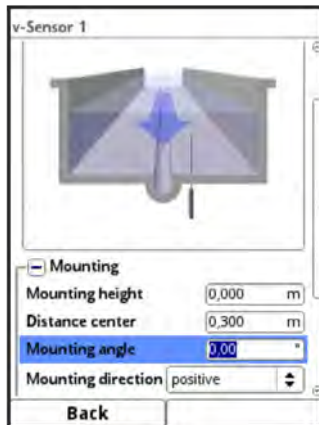

Fig. 39-27 v-Sensor Mounting Height too low

If a sensor has to be mounted on a **block** due to of the risk of **sludge deposits** or **sedimentation**, also take this distance into account.

➡ Procedure:

1. Determine the position of the sensors in relation to the zero point of the application. The reference point is the lower edge of the mounting plate, for tube sensors the horizontal area of the sensor head.
2. Enter this distance in the field >Mounting Height<.

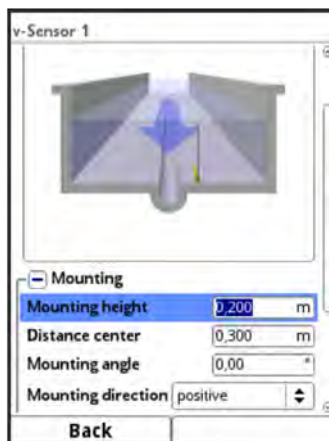

Fig. 39-28 Correctly parameterised Mounting Height v-Sensor

Input Field >Distance Centre< (only if >Flush with wall< is not activated/available)



Note

In contrast to the usual way of looking at it, the user looks with the flow direction, the v-sensors point in the direction of the user.

When setting the parameters, observe that the real installation is rotated by 180°.

The sensor parameters are set as follows:

- v-sensor 1 is always in the centre

The calculation in the transmitter is always based on the central installation of the v-sensor. If the v-sensor is mounted off-centre, this offset must be entered in the >Distance Centre< field.

- Entering a negative value moves the sensor to the left.
- Entering a positive value moves the sensor to the right.

With two v-sensors, the position of the sensors must be entered in the field >Distance Centre<. The value refers to the centre of the application.

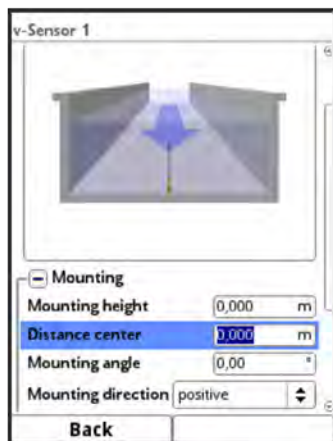

Fig. 39-29 Entering the Sensor Position, relative to the Application Centre

Input Field >Mounting Angle<

Default setting: v-sensor always measures the flow velocity vertically upwards.

In some applications it is necessary to install the sensor at an angle or even horizontally:

- inclined at the slope of a trapezoidal channel
- on the side of channel walls
- in the rounding of a pipe, egg or U-profile

In this case, store the changed beam angle in the transmitter. The reference point is the vertical, upward beam of the ultrasonic signal.

The following applies to the parameterisation of the **inclination of the beam angle** (against the direction of flow):

- negative value - slope to the left
- positive value - slope to the right
- 90° - horizontal beam
- 180° - beam downward (e.g. in applications with float)

Mounting Direction

This special parameter is only used for special applications.

Default setting: mounting direction of the sensors always >positive< (i.e. measuring direction against the flow direction).



Note

Do not modify this parameter. Entering >negative< returns invalid or incorrect flow velocity values.



Fig. 39-30 Option to change the Sensor Mounting Direction

39.3.4 Weighting

When using several flow velocity sensors, define the value of each flow velocity sensor to the measurement result of the average total velocity. The entry is made in the >Weighting< field.

Default setting: 100 %



Note

The value of the weighting depends on the application and the sensor position.

Applications with multiple flow velocity sensors require extensive knowledge of fluid mechanics and require the use of NIVUS commissioning personnel or an authorised specialist company.

The weighting is a dimensionless number between 0.0 and 100.0.

If only **one** v-sensor is used, entering a value other than "100" does not affect the results because the readings from the single sensor are always counted as 100 %.

When using **two or more** sensors at one measuring point, the entered values for the weighting (= "Wght." in the following examples) of the individual flow velocity sensors influence the total measured values output.

With **two** v-sensors applies:

$$\text{Share Sensor 1} = \frac{\text{Wght. Sensor 1}}{\text{Wght. Sensor 1} + \text{Wght. Sensor 2}} \cdot 100 \%$$

$$\text{Share Sensor 2} = \frac{\text{Wght. Sensor 2}}{\text{Wght. Sensor 1} + \text{Wght. Sensor 2}} \cdot 100 \%$$

With **three** v-sensors applies:

$$\text{Share Sensor 1} = \frac{\text{Wght. Sensor 1}}{\text{Wght. Sensor 1} + \text{Wght. Sensor 2} + \text{Wght. Sensor 3}} \cdot 100 \%$$

$$\text{Share Sensor 2} = \frac{\text{Wght. Sensor 2}}{\text{Wght. Sensor 1} + \text{Wght. Sensor 2} + \text{Wght. Sensor 3}} \cdot 100 \%$$

$$\text{Share Sensor 3} = \frac{\text{Wght. Sensor 3}}{\text{Wght. Sensor 1} + \text{Wght. Sensor 2} + \text{Wght. Sensor 3}} \cdot 100 \%$$

For **four and more** v-sensors, the formula can be extended by the number of sensors as desired.

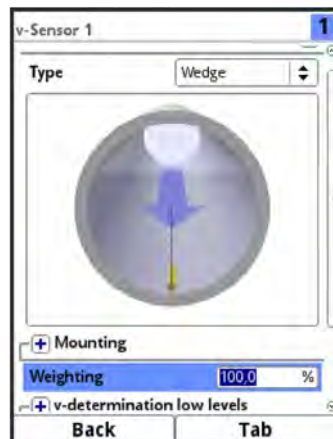

Fig. 39-31 Weighting v-Sensors

39.3.5 v-Determination low Levels

Physically and due to their design, the flow velocity sensors can no longer measure the flow velocity when the filling level falls below a minimum level. This minimum level is approximately between 3 and 8 cm, depending on the sensor type.

This minimum level is called **h-crit**.

Unfavourable applications (e.g. strong wave movements) or the elevated installation of the sensors may increase this value.



Fig. 39-32 Submenu: v-Determination low Levels

The >v-Determination low Levels< menu facilitates the recording of temporarily low flow rates (e.g. nightly discharges, extraneous water or similar).

Requirements for this function:

- No backwater in the application
- Reliable and exact measurement of the existing filling level, even down to a level of 0 mm.

Tip:

This measurement can only be done with an air-ultrasonic measurement.

Working principle of the function:

If the level falls considerably, flow velocity can no longer be measured after a certain point. At the minimum level (h-crit), at which a flow velocity can still be measured, the transmitter cre-

ates an internal v/h value table. The system uses the flow velocity value that is approx. 4 cm above the last measurable flow velocity value. The exponent of the parameterised channel shape is automatically calculated into the curve.

If no more flow velocity can be detected, but a filling level is measured, the system automatically calculates a "suitable" flow velocity within this value table.

v-Determination Automatic

- Rotate the rotary pushbutton until the field >v-Determination Automatic< is highlighted blue.

Default setting: function activated (box checked).

- When h-crit (critical level) is reached, the last measured flow velocity value is automatically stored as the calculation value at lower levels.
The last measured flow velocity value is in the range of approx. 4...5 cm above h-crit and depends on the detected sensor type. This value is entered automatically by the measurement system.
If the level drops below h-crit, the flow velocity value automatically entered by the system is used for the flow calculation.
As soon as the level exceeds h-crit and the range above it (4...5 cm) again and then falls below h-crit again, the newly determined velocity value is used for the next flow calculation.
- If the >v-Determination Automatic< function is deactivated and h-crit is undershot, the system calculates the flow with the entered flow velocity value of >v-manual< from the value >h-manual<.
- If very low levels and backwater are to be expected in the channel, deactivate the checkbox >v-Determination Automatic<.
- Deactivating the selection field >v-Determination Automatic< makes also sense if a standstill of a small medium volume is likely at zero flow.
Set the value in the >v-manual< field to "0". The system then does not calculate a flow rate at the lowest levels.

h-crit automatic

The automatic calculation of the critical height includes the information of the sensor type and the parameterised installation height (see Chapters "39.3.3 Mounting Position of Sensors", Fig. 39-26). The possible lowest level at which a flow velocity can still be measured is automatically determined by the transmitter. If the function is deactivated, the system uses the value entered in >h-manual< as h-crit.

Default setting: function activated (box checked).

h-manual

This input field is used to manually enter a filling level. This level is related to the flow velocity value >v-manual<.

The value in >h-manual< must not be lower than >h-crit<. Otherwise, there is a risk of missing measurement values within the measurement period if the filling level is low.

>h-manual< is only active if >h-crit automatic< is deactivated.

Default setting: >h-manual< is "0".

v-manual

This input field is used to manually enter a flow velocity. This flow rate value is a part of >h-manual< as value pair. The flow velocity value entered can be calculated or modelled for the corresponding level, e.g. by means of hydraulic calculations or discharge models.

>v-manual< is only active if >v-Determination Automatic< is deactivated.

h-crit

This input field is used for the v/h calculation. To do this, enter the level from which the system is to switch to v/h calculation.

Tip:

>h-crit< is only active if >h-crit automatic< is deactivated.

The value entered in >h-crit< must not be higher than the value in >h-manual<.

v-crit

This menu is intended for measurements at levels lower than >h-crit<. The system switches to a calculated value (according to the general Manning-Strickler formula) if the velocity falls below the minimum velocity.

39.3.6 Limiting the Velocity Evaluation

The two input fields >v-Minimum< and >v-Maximum< are relevant for limiting the flow velocity evaluation. The maximum permissible negative and positive velocity values can be entered here.

Possible settings:

>v-Minimum<: -3.500...0.000 m/s

>v-Maximum<: 0.000...6.000 m/s

Absolute measurement span: 7.000 m/s,

i.e. with >v-Minimum< -2.000 m/s, >v-Maximum< can be no more than 5.000 m/s.

A classic application is the prevention of the evaluation of negative flow velocities (backflow).

In this case, the maximum value of the negative flow velocity is simply set to "0".

**Note**

An increase of the possible flow velocity evaluation beyond the technical limits given in chapter "17 Specifications" is not possible and is blocked when trying to input.



Fig. 39-33 Limiting the Velocity Evaluation

39.3.7 Data Transmission Rate**Baud Rate**

The Baud rate stands for the number of transmitted symbols per time unit and thus for the transmission velocity.

Default setting: 115200 Baud.

NIVUS strongly recommends that you keep this setting. Only in very rare cases, when there are communication problems between transmitter and sensor (e.g. when using a very long cable), a reduction of the Baud rate can be helpful. A change should only be made after consultation (or instruction) with the NIVUS head office in Eppingen.



Fig. 39-34 Baud Rate

39.4 Setting Parameters of Inputs and Outputs (analogue and digital)

In this menu, the functions of the analogue and digital inputs and outputs are defined. Further parameter settings such as measurement and output spans, offsets, limit values, error reactions etc. are also possible in this menu.

The >Inputs/Outputs< menu is opened via the main menu.

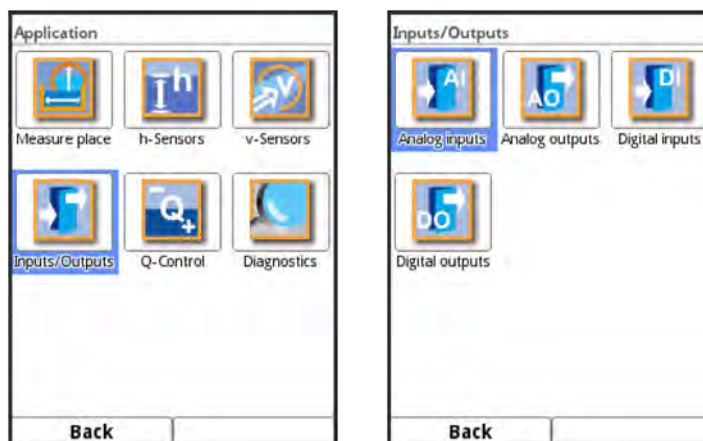

Fig. 39-35 Selecting Inputs and Outputs

The Inputs/Outputs menu is divided into four sections:

- Analogue Inputs
- Analogue Outputs
- Digital Inputs
- Digital Outputs

39.4.1 Analogue Inputs

The number of analogue inputs depends on the device type:

- Type S1 = two analogue inputs
- Type SR = five analogue inputs
- Type M3 = eight analogue inputs
- Type M9 = eight analogue inputs

The available analogue inputs are shown in the top right corner of the display.

Pressing the right control key >Tab< selects the analogue inputs one after the other. The selected input is shown in plain text in the top left corner of the display.

Default setting: analogue inputs inactive.

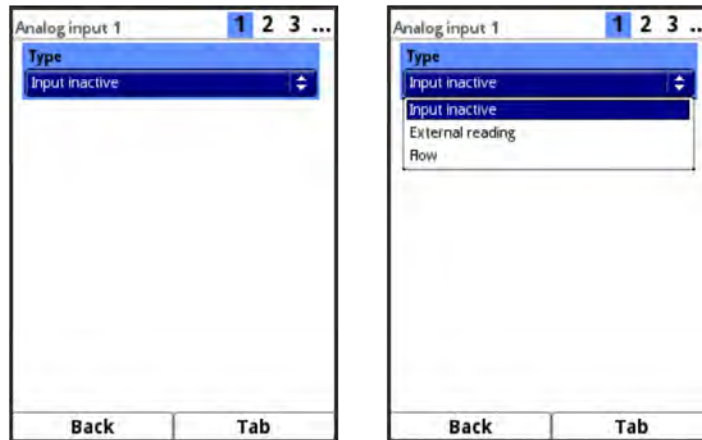

Fig. 39-36 Activation Analogue Inputs

The analogue inputs can be used as external measurement values (e.g. temperature in °C) or for flow measurement (flow calculation by means of a Q/h characteristic, e.g. additional overflow volume calculation at overflow weirs or Venturi measurements by means of a level measurement). The transmitter can hence be used as an additional data logger for measurement values from other systems. Its task as a flow transmitter is not affected by this.

In the case of NivuFlow 750 type M9 transmitters with several measurement places, a further external flow measurement value (e.g. from a separate EMF) can also be applied and thus a total flow value can be calculated from up to four individual measurement values.

Furthermore, it is possible to use analogue input 1 as an external setpoint input when the controller function is activated. In this case, analogue input 1 is hidden during parameterisation. The numbers in the top right corner then start at 2.

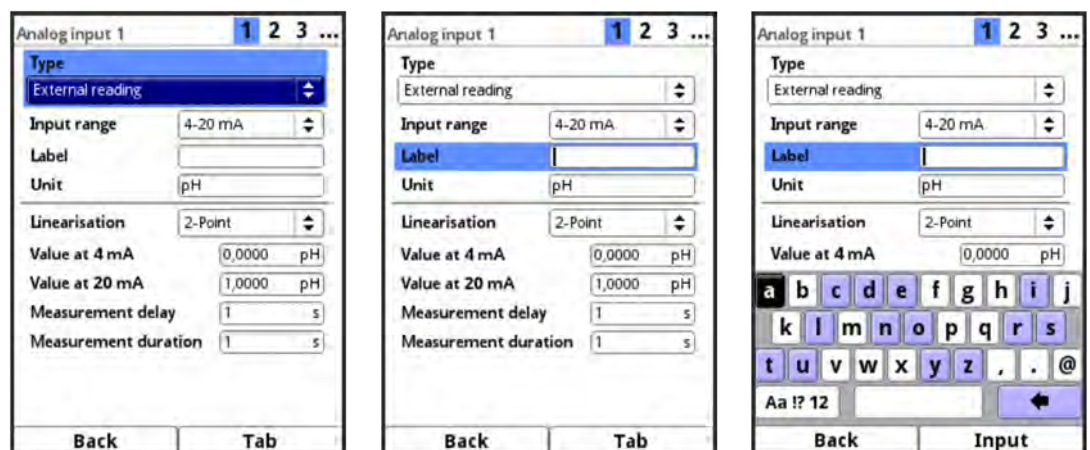

Fig. 39-37 Setting Parameters Analogue Input

After activating the analogue inputs, the input range can optionally be set to >0-20 mA< or >4-20 mA<.

Under Label, a freely selectable name with up to 16 characters can be entered, which is displayed, for example, under Diagnostics for the respective analogue input.

The field for selecting the units is designed as a changeable text field for "External reading", for entering individual units. The number of characters for the units is limited to a maximum of five characters.

For "Flow", the unit (according to the units selected in the country settings) is fixed and cannot be changed.



Note

Input via keypad: see Chapter "28.3 Use/Entry using the letter block".

Finally, parameterise the scaling of the storage.

39.4.2 Analogue Outputs

The number of analogue outputs depends on the device type:

- Type S1 = two analogue outputs
- Type SR = two analogue outputs
- Type M3 = four analogue outputs
- Type M9 = four analogue outputs

The available analogue outputs are shown in the top right corner of the display.

Pressing the right control key >Tab< selects the analogue outputs one after the other. The selected analogue output is shown in plain text in the top left corner of the display.

Default setting: analogue outputs inactive.

Different functions can be assigned to the analogue outputs. It is possible to assign the same function to two analogue outputs in different measurement ranges.

- Example:
 - Analogue output 1 = flow 4-20 mA corresponds to 0-100 l/s
 - Analogue output 2 = flow 4-20 mA corresponds to 0-5000 l/s

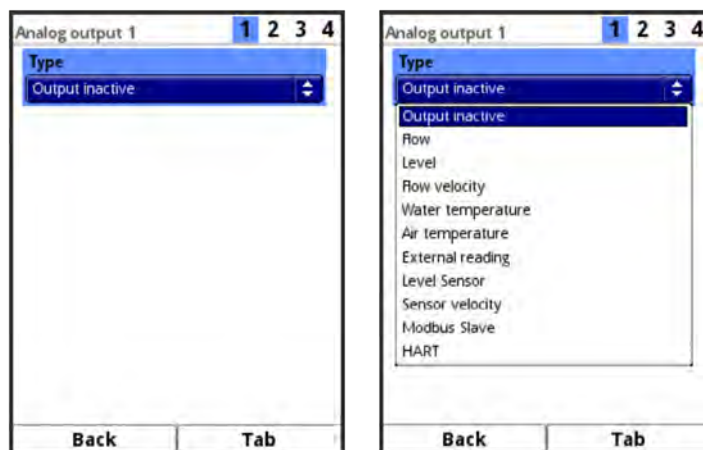

Fig. 39-38 Activation Analogue Outputs

The following functions of the analogue output are possible:

- **Flow**
The flow rate of the application (calculated from average flow velocity and wetted cross-section) is output at the selected analogue output.
- **Level**
The filling level used for the calculation according to the parameter settings is available at the selected analogue output. This is the level that is active in the >Application< />h-Sensors< menu for the current height range.

- Flow Velocity**
 The average calculated flow velocity (also calculated from two, three or more sensors) used to calculate the current flow rate is available at the selected analogue output.
- Water Temperature**
 The medium temperature detected by the flow velocity sensor can be output at the selected analogue output.
- Air Temperature**
 If an air-ultrasonic sensor type OCL-L1 is used in the application, this can be used to output the measured air temperature, which is measured by the sensor to compensate for the sound transit time error.
- Sludge Level**
 In applications where the rate is measured from above by means of a float and the level is recorded with an external or OCL sensor and simultaneously with a water-ultrasonic sensor, the sludge level can be determined and output from the difference between the two level sensors, taking into account the immersion depth.
Tip:
This selection is only visible if "Float" is selected in the v-sensor menu and "Water-US Sludge Level" is selected in the h-sensor menu.
- Externer Reading**
 Measurement values applied to the analogue input and linearised if necessary can be output here again.
- Level Sensor**
 When using a combi wedge sensor, the level measured by the sensor from the bottom can be output here. Depending on the type of combi sensor used, this is either the reading of the integrated pressure measurement cell or the water-ultrasound measurement value.
 For combi sensors that contain both measurements, a selection option for one of the two methods is displayed.
- Sensor Velocity**
 If several flow velocity sensors are used (only possible with Types M3/M9), the measuring path velocity of a single desired flow velocity sensor can be selected here and output in analogue form.

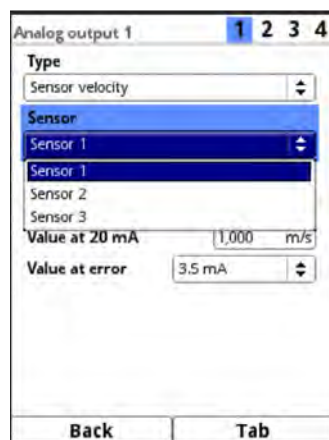

Fig. 39-39 Selection Sensor Velocity

- Modbus Slave**
 The analogue output can be used via the Modbus for the controlled output of a signal from other systems.

- **HART**
The analogue output can be used via HART for the controlled output of a signal from other systems.

The following settings of **Output Range**, **Output Span** and **Value at Error** apply to all functions explained above.

- After selecting the function, the output range can be selected:
 - 0-20 mA
 - 4-20 mA
- Then set the output span.
- If the measurement value fails, an error behaviour can be set for the analogue output. The following settings are possible in the event of an error:
 - 0 mA
 - Hold value (hold the last reading that is still valid) (Hold))
 - 3.5 mA
 - 21 mA

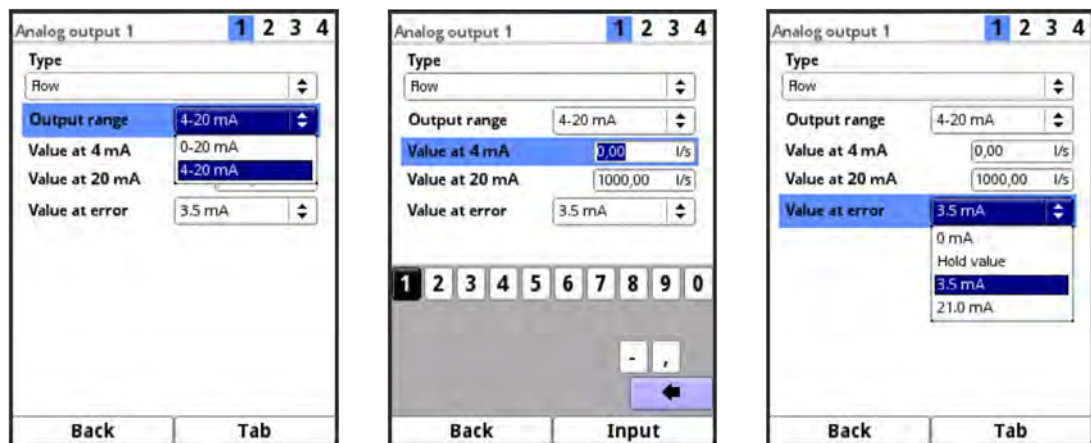

Fig. 39-40 Output Range / Output Span / Value at Error

39.4.3 Digital Inputs

The number of digital inputs depends on the device type:

- Type S1 = two digital inputs
- Type SR = seven digital inputs
- Type M3 = ten digital inputs
- Type M9 = ten digital inputs

The available digital inputs are shown in the top right corner of the display.

Pressing the right control key >Tab< selects the digital inputs one after the other. The selected input is shown in plain text in the top left corner of the display.

Default setting: digital inputs inactive.

Under Label, a freely selectable name with up to 16 characters can be entered, which is displayed, for example, under Diagnostics for the respective digital input.

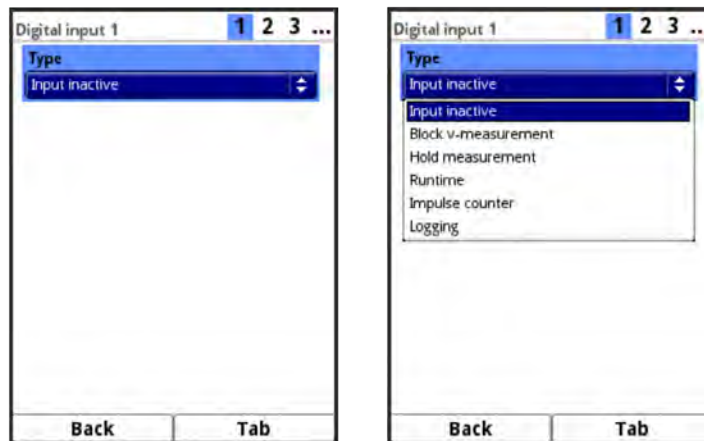

Fig. 39-41 Activation Digital Inputs

The following functions can be assigned to the digital inputs:

- **Block v-Measurement**

By means of an external contact (float switch, pressure bell switch, etc.) the flow measurement can be blocked as long as a signal is present at the digital input. Applications for this are, for example, heavily dammed overflow channels without actual overflow, which show movement due to wind, waves, ship traffic or similar. Here the measurement is enabled via the contactor in the separating structure. The contactor must be positioned just before the start of the overflow.

In addition, the logic can be changed as follows:

- not inverted digital input
- inverted digital input

- **Hold Measurement**

Activation of this digital input causes a "freezing" of the flow measurement value at the time of activation itself. Changing readings or values going to "0" no longer have any effect on the measurement value while the signal is applied to the input. The flow measurement value has an influence on a possible downstream process.

Application Example:

Maintenance/cleaning of the measuring section is carried out, which must be shut down for a short time for this purpose. However, the subsequent process (e.g. regulation with reference to the measured rate) should still continue.

In addition, the logic can be changed as follows:

- not inverted digital input
- inverted digital input

- **Runtime**

The duration of the signal present at the digital input is recorded and stored by the system. This recording is used, for example, for pump or device running times.

In addition, the logic can be changed as follows:

- not inverted digital input
- inverted digital input

- **Impulse Counter**

The number of the signals present at the digital input is counted and stored by the system. The evaluation of the counting impulse is done by detecting the change of state of the digital input (1->0 or 0->1).

A minimum impulse duration of 100 ms is required for reliable detection.

In addition, the logic can be changed as follows:

- rising Edge (change of state from "0" to "1")
- falling Edge (change of state from "1" to "0")

- **Logging**

An applied signal is recorded and stored with start and end time (time stamp function).

The possible applications are:

- Access control
- Logging of events
- Runtimes
- etc.

In addition, the logic can be changed as follows:

- not inverted digital input
- inverted digital input



Fig. 39-42 Changeover options Edge and Logic

In addition, after activating the quantity controller in the Q-controller menu, the following additional functions can be used from digital input 4 or digital input 7 (for Type M3/M9):

- DI 4 / DI 7: >Slider Way CLOSED<
- DI 5 / DI 8: >Slider Way OPEN<
- DI 6 / DI 9: >Slider Torque CLOSED<
- DI 7 / DI 10: >Slider Manual<

These parameters are permanently assigned to the digital inputs.

39.4.4 Digital Outputs

The number of digital outputs depends on the device type:

- Type S1 = two digital outputs
- Type SR = five digital outputs
- Type M3 = six digital outputs
- Type M9 = six digital outputs

The available digital outputs are shown in the top right corner of the display.

Pressing the right control key >Tab< selects the digital outputs one after the other. The selected output is shown in plain text in the top left corner of the display.

Default setting: digital outputs inactive.

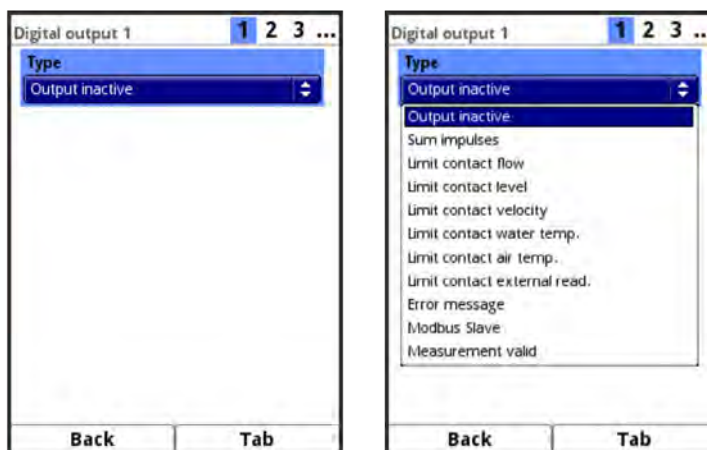

Fig. 39-43 Activation Digital Outputs

The following functions can be assigned to the digital outputs:

- **Sum Impulses**
Quantity-proportional sum impulses of the main sum counter ("Sum" in the main display) are output.
Parameter setting options:
 - Logic (normally closed/normally open)
 - Quantity (pulse per quantity to be defined)
 - Negative sum impulses
 - Duration (relay energised/de-energised);
Adjustable duration: 100...5,000 ms;
The pulse/pause ratio is always 1:1.

If the output frequency of the impulse output is below the frequency of the flow rate when the flow rate increases sharply, the total impulses that have not yet been output are stored internally until the calculated flow rate falls below the impulse frequency again. After that, the sum impulses are also output.

In addition, it is possible to enable the output of negative sum impulses. If this box is activated, only the negative sums (backflow) are output. The positive sums are ignored.

Prerequisite for this selection:

Measuring negative velocities (v-Minimum) is permitted (see Chap. "39.3.6 Limiting the Velocity Evaluation").



Fig. 39-44 Setting Parameters Impulse Generator

- **Limit Contact Flow**

Set a flow limit value for >Threshold On< and >Threshold Off< respectively. If this flow limit is exceeded, a digital signal is output. If the flow falls below the second flow limit value, this digital signal is reset = hysteresis function to prevent fluttering outputs.

In addition, the logic can be changed as follows:

- Normally closed
- Normally open

By ticking >Absolute<, the setting applies to the positive and the negative range.

Furthermore, the behaviour in the event of an error, a delay time and a hold time can be set. Details can be found in the application example below.

Application example for Limit Contact Flow:

- Set >Threshold On< to 1000 l/s.
- Set >Threshold Off< to 900 l/s.
- Activate >Absolute< by checking the box.

If the flow now exceeds the value of 1000 l/s, the digital output is activated.

When the flow falls below 900 l/s, the digital output is deactivated again.

*If the flow continues to drop to 0 l/s **and** the flow direction reverses, then the transmitter will measure a **negative flow** when the negative flow rate measurement is activated.*

If the negative flow now rises to -1000 l/s, the digital output is activated again.

When the negative flow rate falls below -900 l/s, the digital output is deactivated again.

Info:

*If a **measurement value error** occurs (measured value is recognised as invalid by the system), the reaction of the digital output can be defined. A distinction can be made between "Off" (relay energised), "On" (relay de-energised) and "Hold value" (relay remains in the position where it was before the error).*

*By entering a **delay time**, the relay only switches when the conditions for the state to be output are present without interruption for at least this entered delay time and also continue to be present at the time switching point. This function is often used to ignore short-term limit value violations (caused by sloshing water, waves, brief pumping processes or similar).*

*Entering a **hold time** has the exact opposite effect as the delay time. Here, a reaction of the digital output can be prevented by entering the time when a limit value is briefly undershot.*

At the same time, this parameter also offers the possibility to set a required minimum output time even with only very short pending limit values.



Fig. 39-45 Setting Parameters Limit Contact

- **Limit Contact Level**
 The limit contact level is used in exactly the same way as the limit contact flow.
 Setting the level limit value.
 The level that is active in the menu >Application< / >h-Sensors< for the current height range is used for the calculation. A freely selectable level sensor cannot be used.
 The settings and functionalities correspond to the procedure for >Limit Contact Flow< (see page 126).
- **Limit Contact Velocity**
 Here the digital signal is output when an adjustable velocity limit value is exceeded.
 The average calculated flow velocity (also calculated from two, three or more sensors) is used for this function.
 The settings and functionalities correspond to the procedure for >Limit Contact Flow< (see page 126).
- **Limit Contact Water Temperature**
 The digital signal is output here when the water temperature exceeds or falls below an adjustable value.
 The settings and functionalities correspond to the procedure for >Limit Contact Flow< (see page 126).
Application examples for limit contact water temperature:
 - Exceeding the permissible temperature in Ex areas
 - Exceeding the permissible operating temperature of the sensor (danger of sensor damage)
 - Frost protection alert (danger of freezing of the measurement technology)
- **Limit Contact Air Temperature**
 The limit contact air temperature only works when using an OCL air ultrasonic sensor or an i-Sensor with HART protocol.
 The settings and functionalities correspond to the procedure for >Limit Contact Flow< (see page 126).

- **Limit Contact Sludge**

For part filled applications, the sediment level can be determined and output. The requirements for this are:

- Use of a float
- Determination of the sediment distance by means of water-ultrasound from the float
- Determination of the water level using an external sensor or air-ultrasonic sensor type OCL

The sediment level can be calculated from the difference between the two level sensors. If the sludge level is exceeded or not reached, a limit contact can be set or reset. The immersion depth of the water-ultrasonic sensor, measured from the water surface, must be taken into account when setting the parameters (entering the position of the sensor attached to the float).

Attention:

Soft sludge layers may not reflect ultrasound. In this case, the sediment height cannot be measured.

The settings and functionalities correspond to the procedure for >Limit Contact Flow< (see page 126).

- **Limit Contact External Reading**

The limit contact for an external measurement can only be used if at least one analogue input is set to "External Reading".

The settings and functionalities correspond to the procedure for >Limit Contact Flow< (see page 126).



Fig. 39-46 Setting Parameters Limit Contact External Reading

- **Error Message**

By activating the individual selection fields using the push button, the individual error types to be output can be assigned to the digital output.

The possibility of output >h-Measurement< only exists when using 4-20 mA level inputs (falling below 3.6 mA) or when using a water ultrasonic sensor type POA-V2H, POA-V2U and/or air ultrasonic sensor type OCL.

The error >T-Measurement< is possible when using POA, CS2, CSM and OCL sensors. It signals the complete failure of the temperature measurement in these sensors. For exceeding or falling below temperature limits, use the limit contact function.

The error >Q-Controller< is only visible when the controller function of the transmitter is activated. It outputs errors in the control behaviour, missing external setpoints, a blocked slider blade, etc. Detailed information see Chap. "39.5 Setting Parameters of

the Q-Controller". The output of the system errors occurs, among other things, during manual booting and updating of the unit, during restart after a programme sequence error, during cold starts (start-up after power failure) and after setting the time.

The errors can - like the other functions - be output with a delay or continue to be output (hold) for a definable time after the cause of the error has been eliminated.



Digital output 2 cannot be selected as error output

Digital output 2 is not suitable as an error output since it is designed as a bistable relay. The relay remains in its last position in a de-energised state and cannot be used for error messages.



Fig. 39-47 Error Message

- **Modbus Slave**

The digital output can be used via the Modbus for the controlled output of a signal from other systems.



Fig. 39-48 Modbus Slave

- **Slider OPEN / Slider CLOSED**

For transmitters type SR with activated controller function, digital output 4 is reserved for the control of >Slider CLOSED< and digital output 5 for the control of >Slider OPEN<.

For transmitters type M3 and M9 these are digital output 5 for >Slider CLOSED< and digital output 6 for >Slider OPEN<.

The slider controls cannot be made with any other digital output. The visibility and selection of the slider control is therefore limited to these two digital outputs respectively.



Fig. 39-49 Slider OPEN / Slider CLOSED

- Measurement valid**
 Defines the time period during which the last valid measurement value is retained in the event of an invalid measurement. This time period is especially important when using externally connected data loggers so that they can access data values in powerdown mode / clock mode (see Chap. "41.5.2 Powerdown Mode / Clock Control (function can be added via licence)").

39.5 Setting Parameters of the Q-Controller

For transmitters with available controller function, this must first be activated in the menu >Application< / >Q-Controller< by setting the check mark.

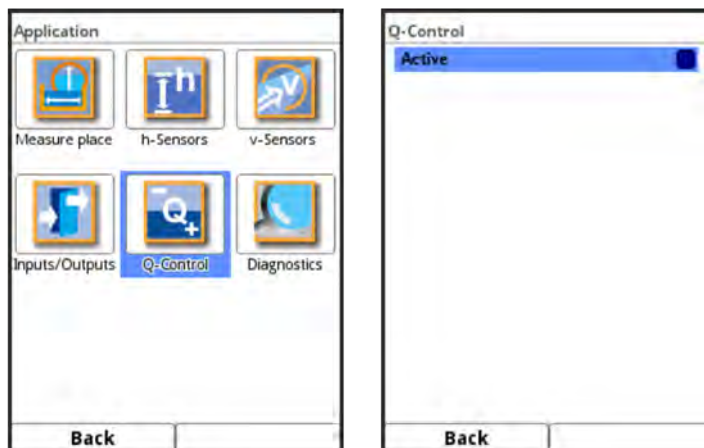

Fig. 39-50 Q-Controller

The following parameters are then available for setting the Q-Controller.

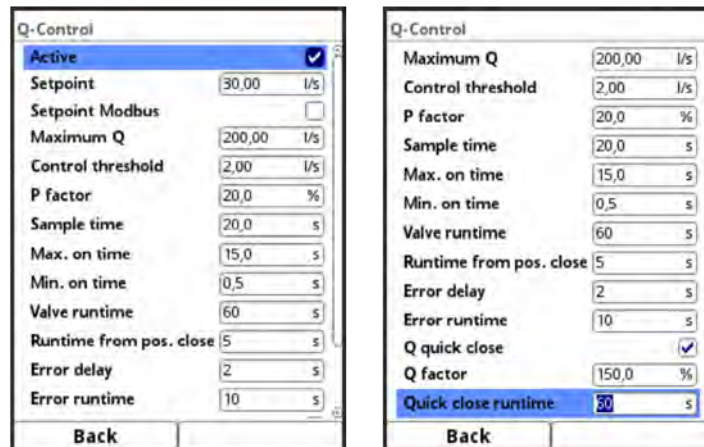

Fig. 39-51 Setting parameters for the Q-Controller

- Setpoint w**

This parameter defines the flow value to be controlled in the application. This is the internal setpoint of the unit. If an external setpoint is also used, programmed via the associated analogue input, the internal setpoint becomes ineffective. Only in the event of an error (e.g. cable break of the external 4-20 mA setpoint) does the firmware use the additionally entered internal setpoint as a substitute.
- Setpoint Modbus**

This activation field is only visible if no external setpoint is used via the analogue input.

In this case, the control setpoint is specified by the Modbus. If the Modbus does not provide a preset, the parameterised internal control setpoint is accessed.
- Maximum Q**

This parameter identifies the maximum occurring flow value at the measurement place. It is used to calculate the actuating time.
- Control Threshold**

The control threshold is also called control deviation in the control circuit area. This parameter defines the permissible control deviation of the control circuit without a control signal being output for the slider.

Flow measurements - especially in the partial fillings - tend to fluctuate slightly in practice for hydraulic reasons. If no setpoint deviation were allowed, the controller would constantly try to match the actual value exactly to the setpoint. This leads to constant actuator actuation and ultimately to increased wear and even defect of the slider.

Info:

In the area of sewer network management (stormwater treatment plants such as stormwater overflow tanks, stormwater retention basins, etc.), the DWA prescribes separation severities of 20 % for throttle discharge. This means a reasonable setting of the permissible control deviation of approx. 10...15 % of the setpoint w for low-wear operation of the controller.
- P-Factor**

The P-Factor (proportionality factor) indicates which actuating time effect a deviation Δw from the setpoint w has.

The greater the proportionality factor, the longer the actuating time of the slider with the same control deviation.
- Sample Time**

The sample time, also called cycle time, describes the processing interval of the controller. A short cycle time accelerates the control behaviour (faster reaching of the

setpoint in case of a control deviation), but leads to oscillation of the control circuit after a certain point in case of longer running times of the medium (= idle time in the control circuit) between the actuator and the measuring point.

A long cycle time reduces the tendency of the controller to oscillate, but at the same time increases the inertia of the control system.

Practice-oriented value:

$$\text{Sample time} = \frac{\text{Average flow velocity}}{\text{Distance between actuator and measurement [m]}} \cdot 1.3$$

- **Max. On Time**

The maximum control time for the actuator avoids overshooting of the controller function in the case of extremely large setpoint deviations and actuators with a short total slider runtime.

- **Min. On Time**

The minimum control time (control impulse time) refers to the minimum running time of the actuator.

This parameter is similar in function to the I-component of classic PID controllers. It defines a minimum long actuating time so that calculated smallest control pulses have such a long time that this actuation still causes a change of the actuator at all due to mechanical play.

Practice-oriented value:

$$\text{Min. On Time} > \text{Relay switching time/switching contactor} + \text{Motor start-up time} + \text{Gear backlash} + \text{Slider play}$$

- **Valve Runtime**

The parameter is used to monitor spindle breakage, slider blade breakage, power failure of the servomotor, gear damage and other errors that manifest themselves in the fact that no further positioning movements are carried out despite control signals being present.

If the actuator does not reach the CLOSED limit switch after the specified total slider runtime, the system goes into error mode.

Practice-oriented value:

$$\text{Slider runtime to be set} = \frac{\text{Time of the slider from OPEN to CLOSED position in continuous operation}}{\cdot 1.2 \dots 2.0 \text{ *)}}$$

*) smaller factor with longer slider runtime

Info:

The slider runtime has an influence on the calculation of the impulse time, has a similar effect as the P-Factor and must not be set to "0".

- **Runtime from Pos. close**

Defined time period until the zero position/error position is approached after a closing (CLOSED position).

- **Error Delay**

This parameter hides error messages that occur for a short time so that the system does not immediately go into error mode in the event of slightest disturbances. Specify the time in seconds.

- **Error Runtime**

Movement time of the slider in the "OPEN" direction in the event of an error.

A error occurs when the slider does not close due to stones or similar and the torque switch "CLOSED" is triggered before the switch "Way CLOSED".

Specify the time in seconds.

- **Q Quick Close**

This parameter serves as the release signal for the two subsequent parameters: Q-Factor and Quick Close Time. It activates the quick close function of a slider in case of an event.

The quick close function is mainly used for large nominal diameters, long slider run-times and long idle times. In the event of sudden rainfall events with torrential water volumes in large channels, it is used to move the control valve from the "OPEN" state to a time-defined, partially closed "CLOSED" state, irrespective of the calculated actuating time, thus preventing flooding. The closing takes place in continuous operation without interrupting the slider runtime.

- **Q-Factor**

Only visible with activated Q Quick Close.

If the control setpoint is abruptly exceeded by the set Q-Factor, the slider moves to the "CLOSED" state (in the time defined under Quick Close Time).

The setting is made in % and refers to the setpoint w.

- **Quick Close Runtime**

Only visible with activated Q Quick Close.

When the quick close is triggered, the slider closes from the "OPEN" state in the defined time.

39.6 Diagnostics

The diagnostics menu is required at the end of parameterisation or for troubleshooting during operation. Therefore, this menu is described after setting the parameters in Chapter "Diagnostics" starting at page 179.

40 Parameter Menu Application/Combi

40.1 General Information

The NF750 M9 transmitters are characterised by the fact that more than three flow velocity sensors can be connected to them by using an MPX or iXT. Depending on its configuration (see also Chapter "18.1 Device Types"), the transmitter can evaluate one, two or three different measurement places.

The transmitters with two/three measurement places also have an internal, "virtual" measurement place, the combination measurement place. This allows to combine the flow totals of the real measurement places into a common, "virtual" third or fourth measurement place. Additions or subtractions of the individual totals are possible, e.g. in order to

- determine the discharge total from the measurement of two inlets by adding them together
- or in an application with three inlets and one outlet, determine the inflow total 3 by subtracting the measured inflow total 1 and 2 from the measured discharge total.

Furthermore, it is possible to connect an external 4-20 mA flow measurement value (e.g. the output of an inductive flow meter) to an analogue input of the NivuFlow 750, define this analogue input as flow measurement value 4 and include it in the calculation of the combination measurement place.



Delivery status of the transmitters with multiple measurement places

On delivery, only measurement place MP1 is activated for the transmitters with multiple measurement places. Therefore, all available sensor inputs and all analogue and digital inputs/outputs are also assigned to the MP1 measurement place.

Prior to setting the parameters of the combi measurement place, the measurement places 2/3 must be activated. (see Chap. "39.1.1 Active/Activation of Measurement Places (only for NivuFlow 750 Type M9 with multiple Measurement Places)").

The corresponding assignment of the sensors and inputs/outputs to the measurement places is carried out according to Chap. "45.3 For Transmitters Type M9".



Prerequisites for setting up the virtual combi measurement place

- I. All individual measurement places are active.
- II. All used sensors and inputs/outputs are active.
- III. The assignment of the sensors and the inputs/outputs in the >Connections< menu has been made.
- IV. The parameterisation of the individual measuring points including the sensors and inputs/outputs is completed.

40.2 Name of the measurement place

The proposed **name of the measurement place** "Combi" can be easily changed as with all other measurement places(see Chap. "28.3 Use/Entry using the letter block").

40.3 Calculation

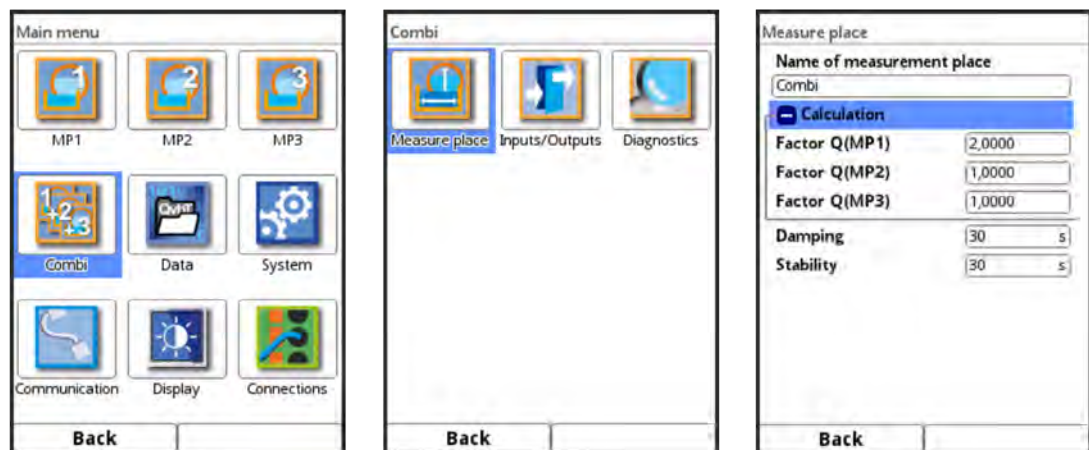

Fig. 40-1 Combi Measurement Place

The **parameterisation of the combi measurement place** essentially consists of defining the >Calculation<.

The individual totals of the measurement placed are classified according to the parameterised factors Q in terms of how many percent they should be included into the total flow rate.

The value 1 for **Factor Q(MPx)** means that the total of the respective measurement place is included in the calculation at 100 %.

If the value is less than 1, the corresponding measurement place is included with less than 100 % (0.9 with 90 %, 0.78 with 78 %, etc.), i.e. it is disproportionately lower included in the calculation. A value greater than 1 then means a disproportionately higher influence on the total (higher than 100 %).

If the individual total of a measurement place is to be subtracted, prefix the factor with a "-" (-1).

Application Example:

MP1 = Inlet 1

MP2 = Inlet 2

MP3 = Discharge Total

Inlet 3 to the common measurement place that cannot be measured directly (e.g. due to hydraulic reasons) is to be calculated.

Required calculation:

Inlet 3 = Discharge Total - Inlet 1 - Inlet 2 = MP3 - MP1 - MP2

Factor parameters (all measurement places are included at 100 %):

Factor Q(MP1): -1.0

Factor Q(MP2): -1.0

Factor Q(MP3): 1.0

➡ Procedure for **including inputs/outputs** (using the example of an analogue input) in the calculation of the combi measurement place:

1. Assign analogue input to the combi measurement place under >Main Menu< / >Connections< / >Analogue Inputs<. (see Chap. "45.3 For Transmitters Type M9").
2. Assign the type "Flow" to the corresponding analogue input under >Main Menu< / >Combi< / >Inputs/Outputs< / >Analogue Inputs<.
3. Enter factor Q(AEx) analogue to the factors Q(MPx) of the measurement places.

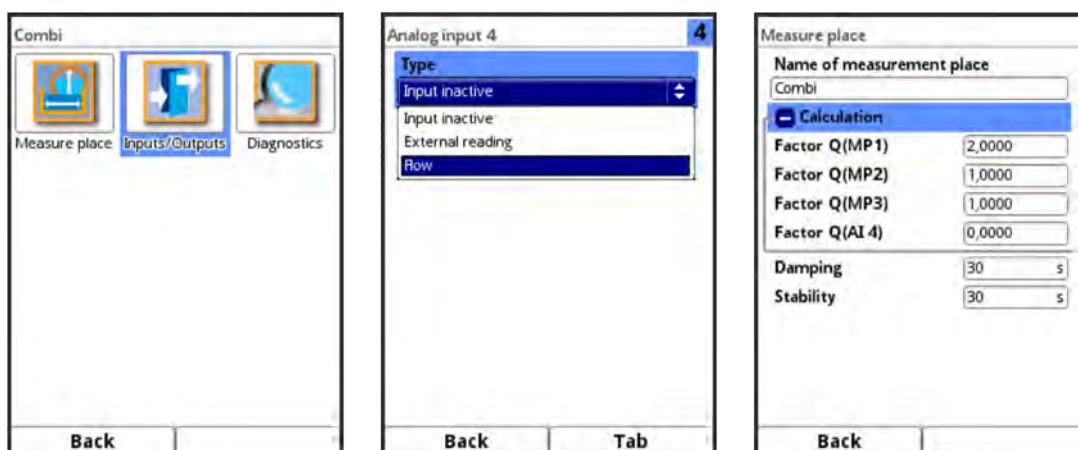

Fig. 40-2 Calculation incl. Analogue Input

40.4 Damping

According to the parameterisation of the damping in the (individual) measurement place under Application.

➡ See Chap. "39.1.7 Damping".

40.5 Stability

According to the parameterisation of the stability in the (individual) measurement place under Application.

➡ See Chap. "39.1.8 Stability".

41 Parameter Menu Data

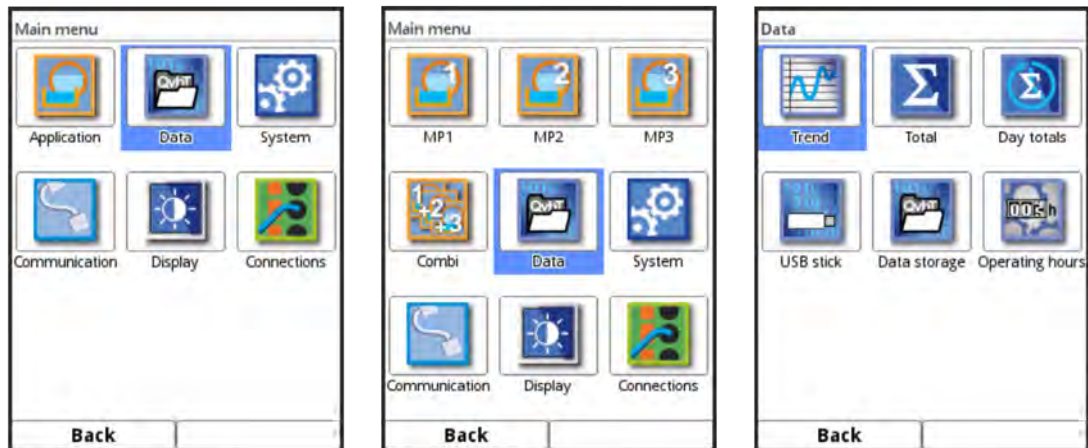

Fig. 41-1 Data Menu

The data menu is primarily a display menu (recorder functions, totals, operating times, etc.). Furthermore, internally stored measurement values as well as the parameterisation of the measurement instrument can be loaded onto a USB stick (to be plugged in).

For the NivuFlow 750 Type M9 with two or three measuring points, the tab key then displayed can be used to scroll between the individual active measurement places.

41.1 Trend

The trend display is a visualising recorder function. When the trend display is selected, the previously stored (historical) measurement data can be accessed.

The individual measurement places of the NivuFlow 750 Type M9 are shown at the top right of the display. Scrolling between the measurement places is possible via the Tab key.

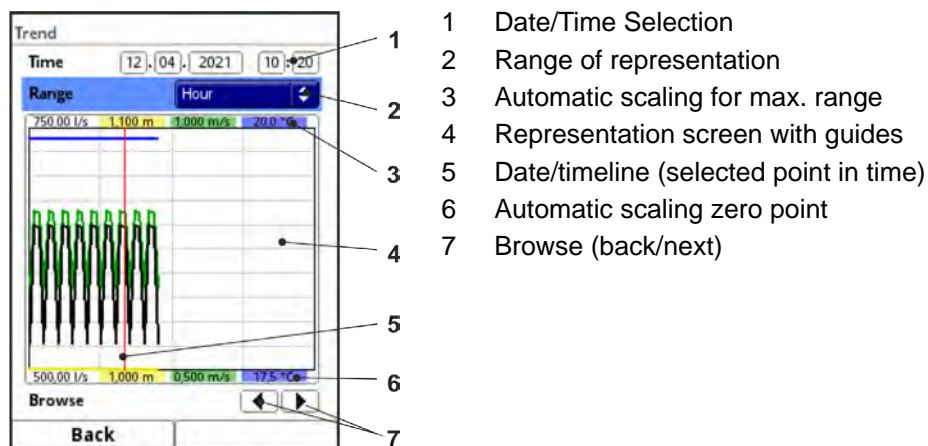

Fig. 41-2 Representation Trend Graph

➡ Procedure for the representation of current readings:

1. Select the desired range (range of representation; Fig. 41-2 Pos. 2).
The selected range (up to the current time) is displayed. During the display, there is no automatic updating of the measurement data (the current measurement data is shown in the lower third of the main screen).
2. If necessary, use the arrows (Fig. 41-2 Pos. 7) to scroll forwards and backwards with the same basic display setting.
3. Press the left function key ("Back") 3 times to return to the main screen.

In the top area of the screen you can find the **Date/Time Selection** (Fig. 41-2 Pos. 1). The line is highlighted in blue and is therefore active.

➡ To select a specific point in time (historical measurement data), proceed as follows:

1. Press the rotary pushbutton - the first field (day) is activated.
2. Enter the desired day.
3. Press the rotary pushbutton again - jump to the next field (month).
4. Repeat the entry until the desired time is entered completely (day, month, year, hour, minute).
5. Confirm entry with the right function key. Date and time are adopted.
The display shows the measurement data of the selected date depending on the set time period (Fig. 41-2 Pos. 2).
The red vertical line (Fig. 41-2 Pos. 5) is on the selected point in time (date and time).

➡ To interrupt your input, press the left function key (Back).

Representation:

The selected period is shown from the left to the right edge of the display.

The **Time Period**, in which the data is to be displayed can be changed.

➡ This setting is made using the >Range< (see Fig. 41-2 Pos. 2).

1. Rotate the rotary pushbutton until >Range< is highlighted blue.
2. Press the rotary pushbutton - the selectable time periods become visible.

The choices are:

- (1) Hour
- 4 Hours
- (1) Day
- (1) Week
- 4 Weeks

3. Rotate the rotary pushbutton until the desired range is highlighted blue.
4. Confirm entry with the right function key. The selected range is adopted.

Representation:

Selection	Representation in the Display Area		
	Left Margin	Right Margin	Guides
Hour	0 Minutes	59 Minutes	15 Minutes each
4 Hours	0/4/8/12/16/20 o'clock, depending on the set time	4 Hours later	1 Hour each
Day	0 o'clock	24 o'clock	4 Hours each
Week	Monday, 0 o'clock	Sunday, 24 o'clock	1 Day each
4 Weeks	Monday, 0 o'clock	4 Weeks later, Sunday, 24 o'clock	1 Week each, time reference point for the start: 29.12.1969, 0 o'clock

Tab. 3 Explanation of the periods displayed



Note

For the time period >4 Weeks< it may take a few seconds until the data is completely loaded.

Below the display you can find the **>Browse<** function.

- Browse forwards or backwards using the arrow symbols: by one selected period unit (Hour, 4 Hours, Day, Week or 4 Weeks) each time the button is pressed.

41.2 Total

The total sum, divided into positive and negative total, is displayed for the respective measurement places. The total sum is the arithmetical sum of the positive and negative total.

Application Example:

Since commissioning, 10,000 cbm³ have flowed over the sensor coming from the front. In the same period, 2,000 cbm³ flowed back from the cable side of the sensor due to backwater.

The display now shows:

- Total 8,000 cbm³
- Positive total 10,000 cbm³
- Negative total 2,000 cbm³

The resettable totals are shown in the bottom area. Their meaning and operation is basically identical to the totals described in the upper section. The resettable totals can, if required, be set to "0" after reading after any period of time via the button **>Reset total<** and count up the totals again from this point on. This makes it easy to determine flow rates between two reading cycles. For security reasons, the reset must be confirmed by entering the password.

With the NivuFlow 750 Type M9 with multiple measurement places, the individual measurement places are shown at the top right of the display. Scrolling between the measurement places is possible via the Tab key.

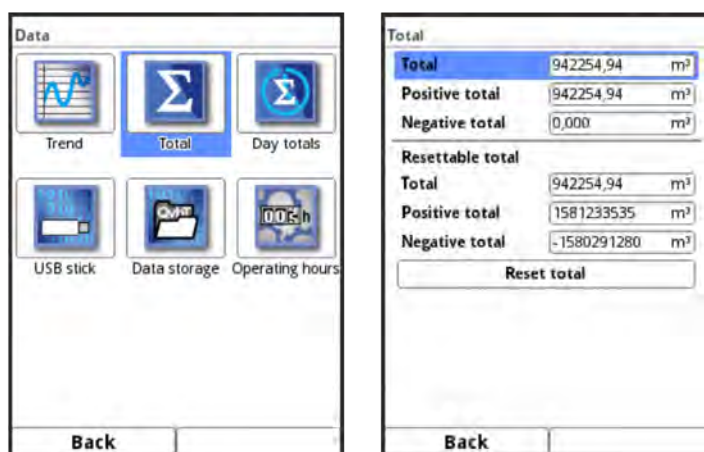

Fig. 41-4 Positive and Negative Totals

41.3 Day Totals

Here, the total flow values or also daily average values can be read in the displayed table. The values are 24-hour values in each case.

The entered update time shows the time at which the value formation takes place daily. This means that the entered value refers to the time range from 24 hours before this date/time to the set date/time.

As per **Default**, the values are always formed at 0.00 o'clock.

With the NivuFlow 750 Type M9 with multiple measurement places, the individual measurement places are shown at the top right of the display. Scrolling between the measurement places is possible via the Tab key.

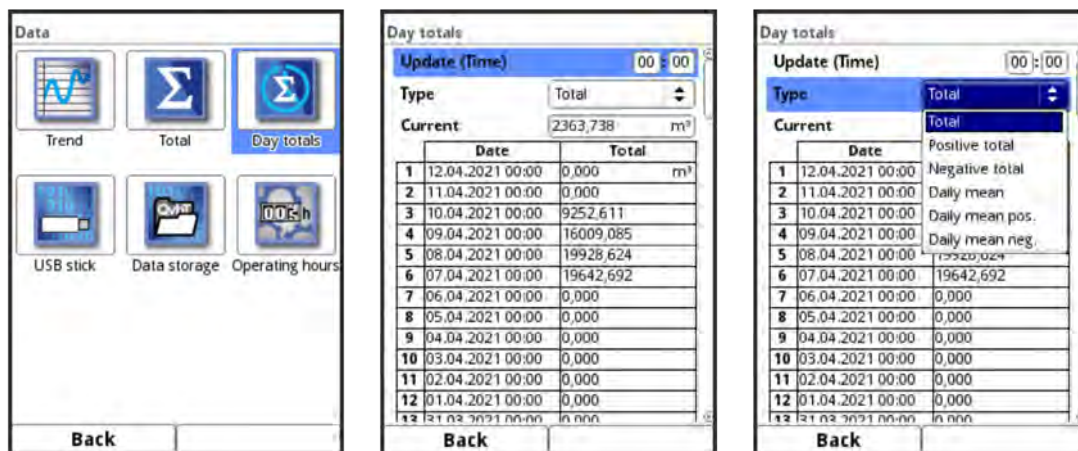

Fig. 41-5 Selecting Day Totals

The representation of the right table column can be changed by means of the setting >Type<. The following display setting options are possible:

- Total: total sums over 24 hrs each
- Positive total: positive totals over 24 hrs each
- Negative total: negative totals over 24 hrs each
- Daily mean: averaged value of the total sum over 24 hours each
- Daily mean pos.: averaged value of the positive total over 24 hours each
- Daily mean neg.: averaged value of the negative total over 24 hours each

Below the button for setting the type, the current daily value is displayed in >Current<. This reading will be moved to the first row of the table at the next update time (after 24 hours at the latest).

A maximum of 100 daily values (= 100 days on which a value was recorded) are stored. From value 101 onwards, the oldest value is always overwritten (ring memory).

- ➡ Turn the rotary pushbutton to the right to scroll down in the table; to the left to scroll up again.

In this way, older daily values can also be displayed. A prerequisite for the display of older values is that the device has also been running for a longer period of time.

Example: 98 values - The device has been running for 98 days

Generally, only the daily values can be read on which the transmitter was actually in operation. If the transmitter is switched off between two totalising events (< 24 hours), the transmitter calculates a total from the **measured** values. This total does **not** correspond to the **actual** daily quantity that flowed, but to the quantity that the transmitter measured while it was switched on. When determining the daily average values, the "0" values during the switched-off period are included in the calculation.

Example:

There is a constant flow rate of 1,000 m³/h. If the transmitter was switched off between 08:00 and 10:00 o'clock, then it measures nothing for two hours. In that case, a total flow rate of 22,000 m³ is displayed at the end of the day. However, 24,000 m³ actually flowed. The transmitter has stored a flow rate of 0 m³ for the duration of these two hours and added it as a valid value to the total flow rate. The daily total does not show that the transmitter did not measure for two hours on this day.

If the transmitter is switched off before the time of the next totalising and then remains switched off until the time of the next totalising (> 24 hours), the transmitter does not calculate a total or an average value for this period of time (see Fig. 41-6). No data is stored and the time period remains unknown. This "gap" can be recognised by the fact that the relevant entry (date/values) is completely missing in the list sequence. No blank lines are shown.

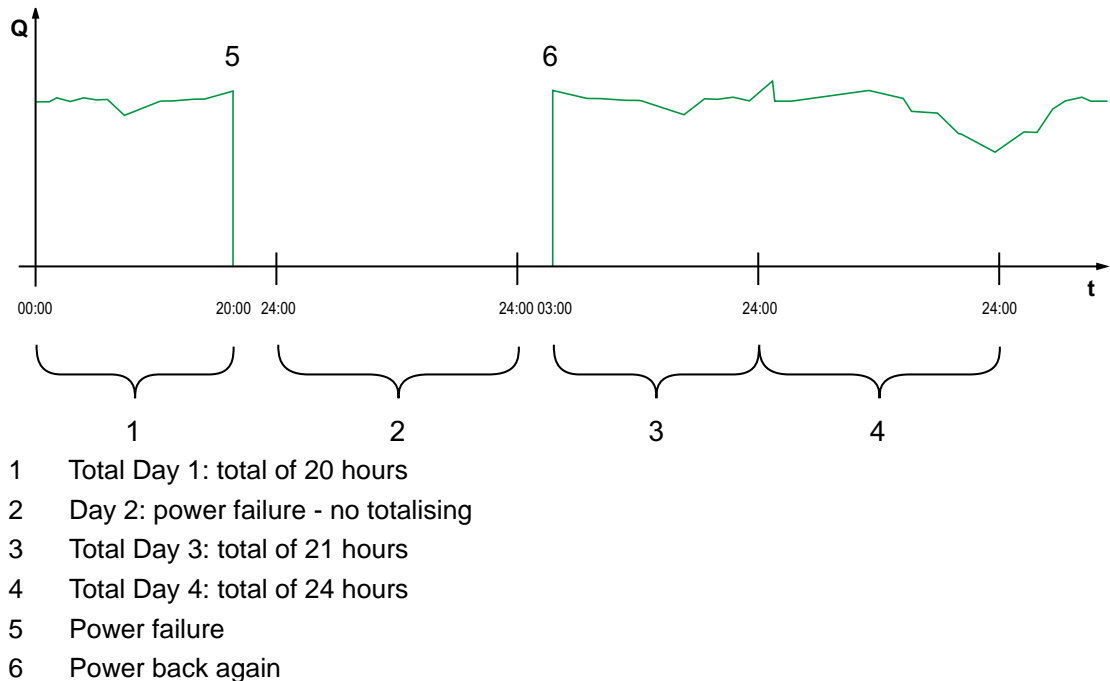

Fig. 41-6 Schemes of Totalising

- The **time** of the totalising is 00:00 o'clock **by default**, but can be changed as described below.
- The factory setting of the time results in the **time period** of the totalising or averaging between 00:00 and 24:00 o'clock. This means that the daily total is always computed between 00:00 and 24:00 o'clock.

➡ Changing the time of totalising is done as follows:

1. Rotate the rotary pushbutton until >Update (Time)< is highlighted blue.
2. Press the rotary pushbutton - the hour section is activated.
3. Enter the desired start time for the totalising (e.g. 08:00) and turn to the minute section.
4. Specify the minute value.
5. Confirm the values with the right >Enter< function key.
The time of totalising is changed to 08:00 o'clock.
This automatically calculates the 24-hour value from 08:00 o'clock to 08:00 the next day.

41.4 USB Stick

Requirements for the USB stick used:

- supports USB 2.0
- formatted as FAT 32 (or FAT 12 or FAT 16)
- max. permissible memory size 32 GB

Working with the USB Stick:

- ➡ Plug the USB stick into the slot above the display.

Function:

- Transmission of measurement data to USB stick
- Backing up device parameters to the USB stick
- Retransfer of saved parameters from the USB stick to the device
- Formatting the USB stick

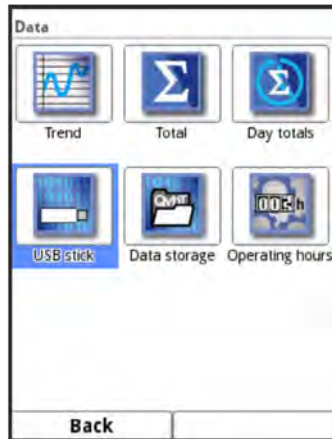
**Fig. 41-7 Selection Submenu**

The transmitter has an internal data memory. If required, part of the measurement data or all stored measurement data can be transferred to a USB stick.

Per default, the transmitter offers the transmission period since the last data transmission up to the current time. This transmission period can be adjusted, however.



To save data to USB stick proceed as follows:

1. Press the rotary pushbutton - the first field is activated.
2. Turn the rotary pushbutton to select the day of the desired start time.
3. Press the rotary pushbutton again - now the month can be specified.
4. Repeat the process until the desired date and time have been entered completely.
5. Confirm the start time with the right >Enter< function key.
6. Turn the rotary pushbutton - the field >to< is highlighted blue.
7. Turn the rotary pushbutton to select the day of the desired end time.
8. Set the end time in the same way as the start time.

This sets the time period for the data to be transferred to the USB stick.

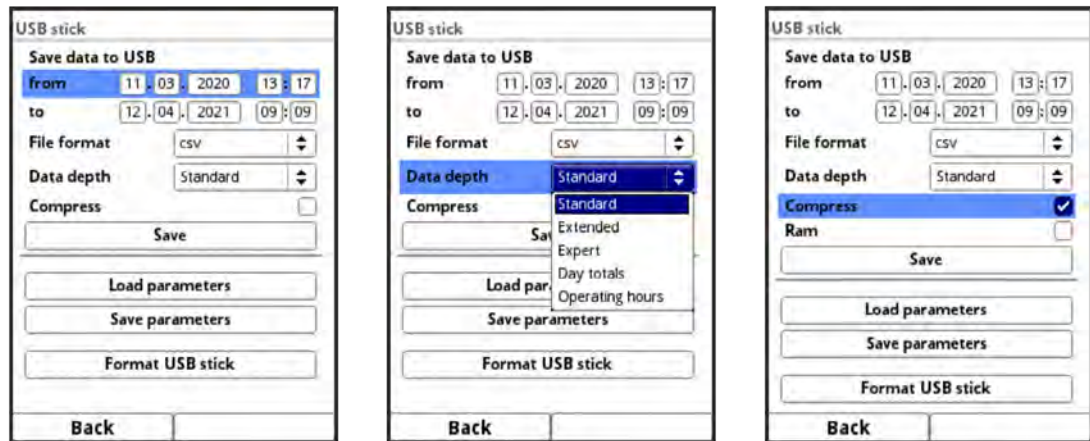

Fig. 41-8 Transmission Period/Data Depth/Compression

9. To select the desired file format, press the rotary pushbutton - a selection menu opens.

The choices are:

- txt
- csv

10. Press the rotary pushbutton to accept the file format.

The adjustable **data depth** comprises five possible selection ranges:

- **Standard**

This memory format is sufficient for most applications.

The stored records contain the following information:

- Date and Time
- Totaliser
- calculated Flow Rate
- Filling Level
- average flow velocity
- Water Temperature
- Air Temperature (if an AUS is used).
- Current values and the values calculated from them for the activated analogue and digital inputs

- **Extended**

This data set is useful for controlling critical important applications and is mainly needed by service personnel.

The stored records contain the following information:

- All data sets from the previous data depth >Standard<
- Average flow velocities of v-sensors 1, 2 and 3 (if used)
- Trigger and hydraulics qualities of v-sensors 1, 2 and 3 (if used)

- **Expert**

Such data sets should only be activated by specially trained **service personnel** or **developers** of the manufacturer. These data sets can quickly become very large.

- All data sets from the previous data depth >Extended<
- All individual gate velocities as well as all gate positions of all connected v-sensors

- **Day Totals**

The totals saved in the menu >Data< / >Day Totals< as well as the positive and negative totals are stored on the plugged USB stick after selecting and pressing the button >Save<.

Application Note:

Only the displayed data records (maximum 100) can be saved.

- **Operating Hours**

The operating hours per day saved in the menu >Data< / >Operating Hours< are stored on the plugged USB stick after selecting and pressing the button >Save<.

Application Note:

Only the displayed data records (maximum 100) can be saved.

The **>Compress< function** is only useful for transmitting large amounts of data. In this case, the selected files are zipped into the ".zip" format. If this option is checked, **>Ram<** can also be selected and the data is written to the internal Ram memory (approx. 16 MB) instead of a USB stick. The selected, stored data can then be retrieved from this ram memory, e.g. via remote access.

➡ Once the transfer period, data format and data depth have been defined, save the data to the USB stick.

1. Activate the >Save< field.
2. Press the rotary pushbutton to save the data to the USB stick.

The generated table can contain the following data or information about the data, depending on the data depth set. The units in [] correspond to the default setting, but can be changed if necessary.

Name	Data Depth	Meaning
Date	Standard, Extended, Expert	Date of the table entry (time of storage)
Time	Standard, Extended, Expert	Time of the table entry (time of storage)
app1_sum [m³]	Standard, Extended, Expert	Positive flow rate total at the time of storage
app1_q [m³/s]	Standard, Extended, Expert	Flow volume at the time of storage, value calculated by the measurement system
app1_h [m]	Standard, Extended, Expert	Filling level at the time of storage, value used by the measurement system

app1_v [m/s]	Standard, Extended, Expert	Average velocity at the time of storage, value used by the measurement system
app1_t_water [°C]	Standard, Extended, Expert	Water temperature at the time of storage
app1_h_current [m]	Extended, Expert	Filling level at the time of storage, raw measurement value of the sensor
p<x>_v [m/s]	Extended, Expert	Average velocity of the sensor <x> (x is placeholder for the sensor number: p1, p2, p3 etc.)
p<x>_v<y> [m/s]	Extended, Expert	Measured flow velocity of sensor <x> in measurement window/gate <y> (y is placeholder for the gate number: v1, v2, v3 etc.)
p<x>_tq [%]	Extended, Expert	Trigger quality, presence of raw values from sensor <x> (depending on reflections)
p<x>_hq [%]	Extended, Expert	Hydraulic quality, measurements outside the histogram filter
p<x>_ntyp [dBμ]	Extended, Expert	Typical noise in the sensor signal
p<x>_nmax [dBμ]	Extended, Expert	Maximum noise in the sensor signal
P<x>_pos1-16 [m]	Expert	Position of the measurement window/gate in the vertical above the bottom
sys_t [°C]	Expert	Temperature within the transmitter

Tab. 9 Information on the Data (USB Storage)

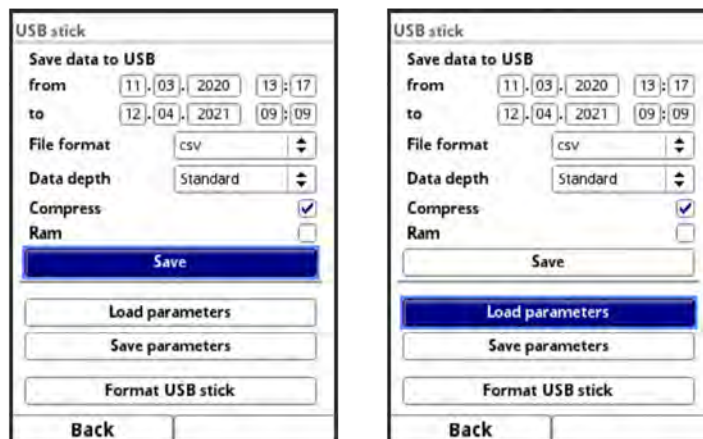

Fig. 41-10 Save/Load Parameters

With the function **>Load Parameters<** a previously saved parameter file can be loaded from the USB stick to the transmitter.

With the function **>Save Parameters<** the set parameterisation of the measurement place can be loaded onto the USB stick. Here two files are created and saved.

The files have the following formats:

- **XXXX_DOC_AABBCCDDEE.pdf**
This file is for documentation purposes and can be opened and printed directly using a pdf reader. In the header, it contains information on the transmitter type, date and time of parameterisation, firmware, serial number and article number of the transmitter.

Basic parameter settings such as measurement place description/dimensions, used and parameterised level sensors, used flow velocity sensors in relation to type, installation position, installation height, installation angle etc. are output.

In addition, the display of the parameter settings of analogue and digital inputs and outputs, a possibly parameterised controller incl. its parameters, various system information such as time/date format, country and device settings as well as Modbus and display settings.

- **XXXX_PAR_AABBCCDDEE.xml**

This file contains the complete parameter set of the transmitter. It is used to save the parameterisation that has been set.

Information on File Naming:

XXXX	=	Name of the measurement place set
AA	=	Year
BB	=	Month
CC	=	Day
DD	=	Hour
EE	=	Minute

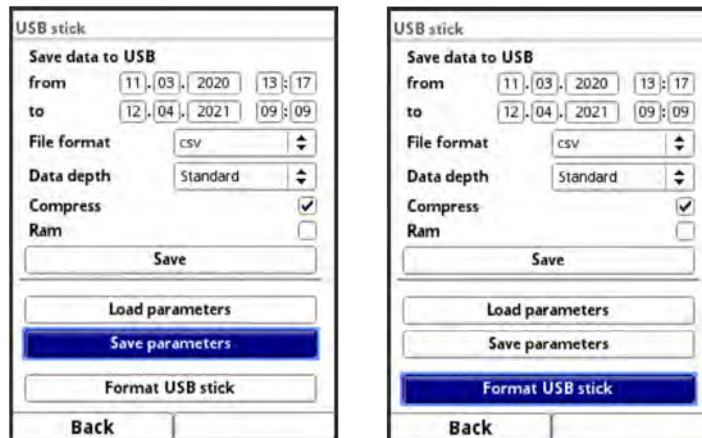

Fig. 41-11 Save Parameters/Format USB

- ➡ Unformatted or incorrectly formatted USB sticks can be converted to the correct storage format directly at the device:
 1. Rotate the rotary pushbutton until >Format USB Stick< is highlighted blue.
 2. Press the rotary pushbutton - the plugged USB stick is formatted.
When the USB stick has been formatted, the message >SUCCESSFUL< appears on the display.

41.5 Data Memory (Internal)

41.5.1 Basic Functions

In this submenu you can change the storage cycle and delete the internal data memory.

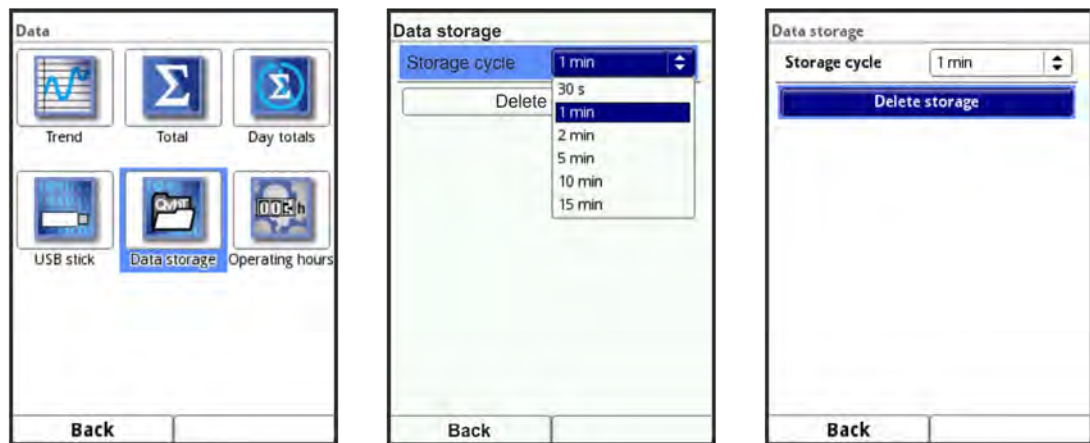

Fig. 41-12 Data Memory

Selection options for the **>Storage Cycle<** are:

- 30 s, 1 min, 2 min, 5 min, 10 min, 15 min

Default setting for the storage cycle: 1 min

The **average value** over the selected cycle is **always** saved, not the instantaneous value at the time of saving.

By using **>Delete Storage<** the stored measurement data in the internal data memory can be deleted. The data is password protected to prevent accidental deletion.



Important Note

Deleted data cannot be resored!

🔄 Procedure:

1. Enter the password to delete the data.
2. Confirm password with the right function key **>Enter<**.

41.5.2 Powerdown Mode / Clock Control (function can be added via licence)

The clock control of the transmitter is used in areas where no permanent supply voltage can be provided and therefore the measurement is supplied by 12 or 24 V DC via rechargeable batteries or standard batteries.

In order to reduce energy consumption in this case, it is possible to operate the measurement cyclically.

This means that the transmitter measures for a defined time, stores the measured values internally and then goes into an energy-saving sleep mode (powerdown) in which it neither measures nor displays measured values.

After a programmed time, the transmitter "wakes up" again, measures and stores the measured values. This cycle repeats in the specified time intervals.

In addition, the transmitter is equipped with a special DC power supply unit that requires extremely little energy in the idle state.

The functionality of the power-down mode / clock control via the internal data memory must be purchased via the **additional function licence** and this function licence must then be activated.

If the transmitter is ordered with a licence (ex works), it will be activated by NIVUS before delivery.

➡ See also Chap. "18.2 Add-On Function Licences" and "42.5.2 Feature Unlock".

In this submenu, in addition to the contents of the basic functions (see chapter "41.5.1 Basic Functions"), the >Operating Mode< and the >Measurement Duration< can also be set.



Fig. 41-13 Data Memory Powerdown / Clock Control



Recommended Procedure

After completing the parameter settings of the clock control, a test run should ideally take place.

- I. To do this, run the measurement for approx. 3...4 programmed storage cycles. The display remains dark during this time.
- II. After the time has elapsed, wake up the transmitter by pressing the rotary pushbutton.
- III. Check the function of the measurement in the parameter menu >Data< / >Trend<.

The selected >Operating Mode< determines when and how often the transmitter should take measurements and also save them. Depending on the operating mode, the storage cycle, the event interval and the event type can be set.

The choices for >Operating Mode< are:

- **>Continuous Operation<**
The transmitter measures continuously, but stores the measured values only at the intervals of the set storage cycle. The permanently determined individual measured values are averaged internally. The average value of the measured values is saved.
- **>Cycle Mode<**
The transmitter wakes up at the intervals of the set storage cycle, measures for a short time, stores the determined measured values and switches off again automatically ("sleep phase" until the next measurement).
For power-saving reasons, the display remains dark all the time and no measured value is displayed during the measurement cycle.
The transmitter can be woken up for approx. 2 minutes by pressing the rotary pushbutton. If the transmitter is currently in a measurement (in the measurement cycle) at the time of waking up, it takes approx. 5 seconds until the current reading is displayed.
If the transmitter is in a sleep phase at the time of waking up, it wakes up, starts the measurement and displays the measurement value for approx. 2 minutes. This reading is not additionally stored during the sleep phase. Then the transmitter turns off again.

- **>Event Mode<**

The event mode is an extended cycle mode. It has the same parameters and functionality as the cycle mode. In addition, it is possible to switch to the >Event Interval< by recognising that a definable measurand has been exceeded or undershot (see page 148). The measurand that triggers event operation is defined via the >Event Type< (see page 149).

In the event interval the transmitter measures cyclically. The event interval can contain much shorter measuring cycles than the cycle mode. This achieves a better measurement value resolution in important time ranges.

Example:

Measurement of the discharge volume in a discharge channel that is normally dry. Here it is sufficient for the transmitter to measure the value "0" in a storage cycle of 15 minutes and to spend the rest of the time in the sleep phase. If a discharge into the channel is then detected (e.g. using a float switch), the transmitter starts, triggered by the event that occurred, and measures in the set event interval/measurement cycle (e.g. 2 minutes). In the time between measurements, the transmitter goes back to sleep to save energy.



Automatic Change of the Operation Mode

If the conditions of event operation are no longer given, the transmitter checks this change of state for 5 measuring cycles. If this change of state persists uninterruptedly for 5 measuring cycles (event interval), the transmitter changes from >Event Mode< to >Cycle Mode<. This safety function is intended to prevent constant switching back and forth (e.g. due to sloshing movements, electromagnetic interference or similar).

- **>Event Continuous Mode<**

The event continuous mode and its parameter settings are largely identical to the event mode.

In contrast, the transmitter does **not** switch **off** cyclically in the event interval **during** the event to save energy, but measures in continuous operation. The data is averaged over the entire time span of the event interval and stored in the cycle of the event interval.

The event continuous mode thus consumes slightly more energy than the event mode, but leads to more consistent measurement results for events with strongly fluctuating measured values (e.g. due to waves).



Automatic Change of the Operation Mode

If the conditions of the event continuous mode are no longer given, the transmitter checks this change of state for 5 measuring cycles. If this change of state persists uninterruptedly for 5 measuring cycles (event interval), the transmitter changes from >Event Continuous Mode< to >Cycle Mode<.

This safety function is intended to prevent constant switching back and forth (e.g. due to sloshing movements, electromagnetic interference or similar).

Selection options for the **>Storage Cycle<** are:

- 30 s (only for continuous operation), 1 min, 2 min, 5 min, 10 min and 15 min

Selection options for the **>Event Interval<** are:

- 1 min, 2 min, 5 min, 10 min and 15 min



Fig. 41-14 Event Type / Mode / Cycle

>Event Type< (only for Event Mode and Event Continuous Mode)

In the operating modes >Event Mode< and >Event Continuous Mode<, the event types "Flow", "Level", " Velocity", "Water Temperature", "Air Temperature", "Digital Input 1" and "Analogue Input 2" can be selected.

Info:

For transmitters NivuFlow 750 Type M9 with multiple measurement places, only measuring point 1 is used for evaluation.

- **Flow:**
The transmitter has changed from the sleep phase to the measurement cycle and has determined a valid flow measurement value.
If this measured value is above the set limit value for "Flow", the transmitter switches to event mode and from now on measures in the parameterised event interval until the flow rate falls below the limit value again for 5 measuring cycles.
The recorded measurement values are saved in the **>Event Interval<**.
By using **>Mode<** it is possible to change from overrun to underrun (see page 150).
- **Level:**
The parameter **>Cycle<** additionally provides to select "Storage Cycle" or "Event Interval".
 - With "**Storage Cycle**", the transmitter reacts in exactly the same way as described under "Flow", only in relation to the level values.
 - With "**Event Interval**", the transmitter monitors the level measurement during the sleep phase. If the limit value is exceeded, the transmitter switches to event mode and from here on works in the same way as described under "Flow", only related to the level values.
Under "Event Interval", the response of the transmitter is faster, but the energy consumption is somewhat higher.
- **Velocity:**
The transmitter reacts in exactly the same way as described under "Flow", only in relation to the velocity values.
- **Water Temperature:**
The transmitter reacts in exactly the same way as described under "Flow", only in relation to the water temperature.
- **Air Temperature:**
The transmitter reacts in exactly the same way as described under "Flow", only in relation to the air temperature.

- **Digital Input 1:**
Here, a potential-free contact such as a float or pressure switch can be used to switch to event mode in the cycle of the set event interval during the sleep phase.
Due to the type of input, very power-saving operation is possible.
- **Analogue Input 2:**
This function uses the possibility of switching to event mode by using an external analogue signal (e.g. exceeding of environmental parameters).
The parameter setting options are identical to those for "Level".

>Mode< (only for Event Mode and Event Continuous Mode)

Here it is defined by selecting ">" or "<" whether the measurement starts when the entered value is exceeded or not reached.



Fig. 41-15 Measurement Duration

>Measurement Duration<

- By setting **>Minimum<**, a minimum measurement duration of the transmitter can be defined. The set time indicates the minimum time for which the transmitter is switched on after measurement start. Extending the minimum measurement duration achieves better averaging in the case of fluctuating flow rates. If the minimum value of the measurement duration is set higher than the cycle time (storage cycle), the transmitter goes into continuous mode.
In addition, a quality check of the measured values is carried out in the background. This prevents no measurement value or a poor measurement value from being stored if the minimum measurement duration is set too short.
- The **>Maximum<** setting limits the measuring time of the transmitter. It thus prevents the quality check running in the background from not producing satisfactory measurement results in the case of difficult measurements (such as media with few particles and slow flow velocities) and the measurement does not return to the idle state despite cycle mode, but constantly attempts to achieve measurement values.
In that case, for energy saving reasons, a "forced shutdown" is carried out and the invalidity marker "#-1" is stored.
- The maximum measurement duration is set to **Maximum Auto.** as per default (checked). In this case, the transmitter determines the optimum maximum setting based on the number of sensors used and activated, analogue inputs and outputs, etc.
If the check mark remains set, the parameter setting is completed and confirmed, then the calculated optimum switch-off time is entered in the **>Maximum<** parameter after the transmitter has been restarted.
NIVUS recommends keeping the factory setting and not entering a manual switch-off time to avoid invalid readings.

41.6 Operating Hours

Here, the number of total operating hours and the individual daily totals can be read in the displayed table. The table values are 24-hour values in each case.

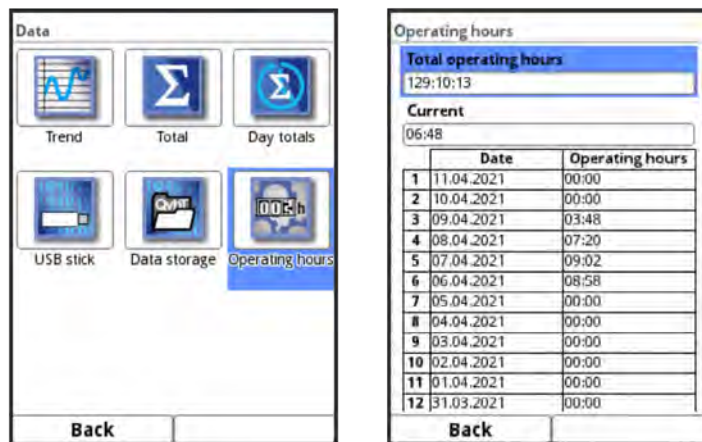

Fig. 41-16 Selection Operating Hours

>Total Operating Hours< shows the operating time of the system since the supply voltage was applied. It runs continuously when voltage is applied and stops when the power supply is interrupted.

Display format:

xx:yy:zz (days:hours:minutes)

>Current< shows the operating time of the measuring system for the current day.

Below this is a table with the daily totals.

A maximum of 100 total values (= 100 days on which a value was recorded) are stored. From value 101 onwards, the oldest value is always overwritten (ring memory).

- ➡ Turn the rotary pushbutton to the right to scroll down in the table; to the left to scroll up again.

In this way, older values can also be displayed. A prerequisite for the display of older values is that the device has also been running for a longer period of time.

Example: 98 values - The device has been running for 98 days

Generally, only the values can be read on which the transmitter was actually in operation.



Note

The operating hours counter is intended for control purposes and for this reason cannot be reset.

42 Parameter Menu System

42.1 Information

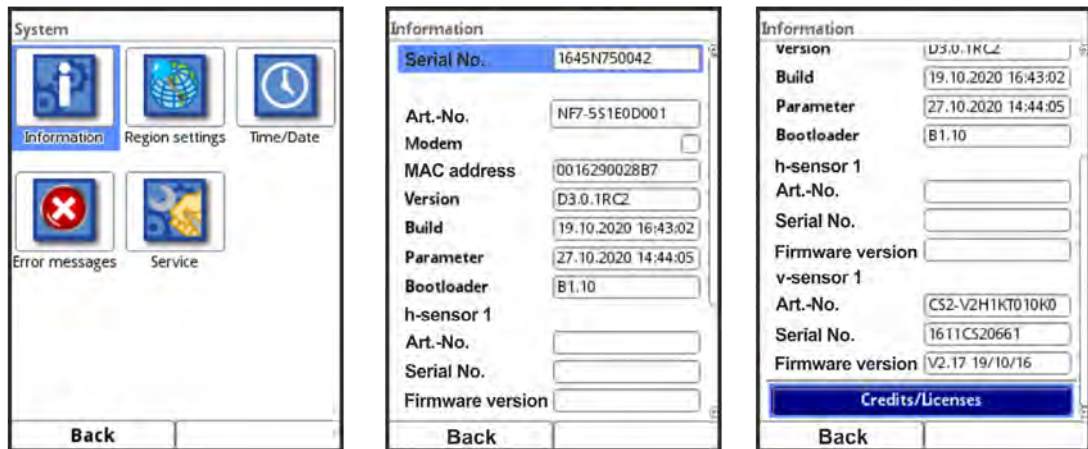

Fig. 42-1 Submenu System/System Information

This menu is a display menu. It contains the following information about the transmitter and the connected sensors and devices:

- Serial number and article number
- MAC Address
- Firmware version
- Specifications on the bootloader and the WLAN version
- Date of the last software update (firmware) and the last parameter storage
- Specifications on connected/activated sensors (serial and article number and firm-ware version)
- Information on credits and licences
- Specifications on connected Ex Separation Modules or multiplexers

By pressing the button **>Credits/Licences<** at the end of the display, the descriptions and links of the open programmes used in the transmitter are saved as pdf to a USB stick to be inserted.

➡ See also Chap. "58 List of references of the licences and codes used".

This menu is primarily used by the authorised service for (initial) information during commissioning, checking or troubleshooting (on site or by telephone).

42.2 Region Settings

In this menu you can make the following settings:

- (Operating) Language
- Date Format
- Units of the measurement values
Here it is possible to distinguish between displayed and stored measured values.

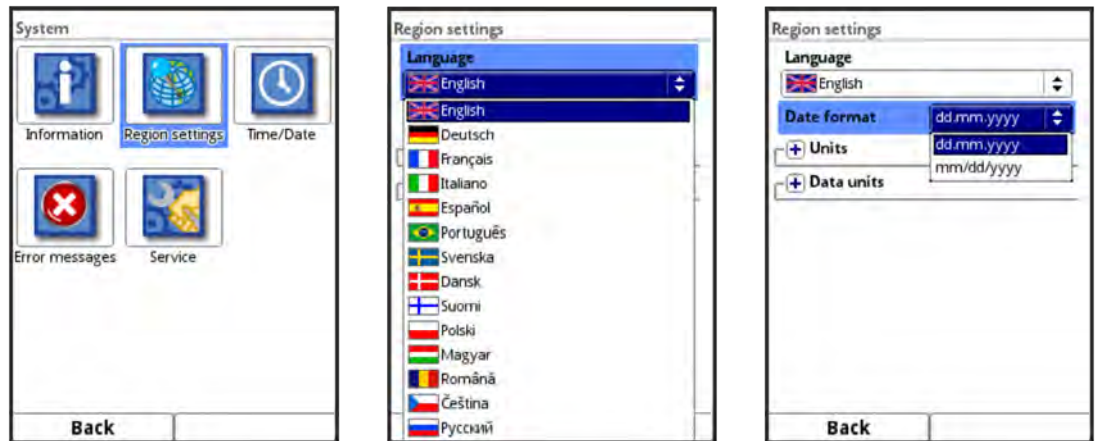

Fig. 42-2 Region Settings/Language/Date Format

42.2.1 (Operating) Language

All listed languages (Fig. 42-2) provide texts in the national language or the substitute language English.

The current selection is:

- English, German, French, Italian, Spanish, Portuguese, Swedish, Danish, Finnish, Polish, Hungarian, Romanian, Czech, Russian, Korean and Chinese

42.2.2 Date Format

The following date formats can be set:

- DD.MM.YYYY (Day/Month/Year)
- MM/DD/YYYY (Month/Day/Year)

42.2.3 Units

➡ Procedure:

1. Rotate the rotary pushbutton until the field >Units< is highlighted blue.
2. Press the rotary pushbutton - the PLUS at the front turns to MINUS and a selection list opens.
3. Turn the rotary pushbutton to the respective selection field.

Decimal Separator

- Comma
- Dot

The decimal separators entered here are only used for the display of the transmitter.

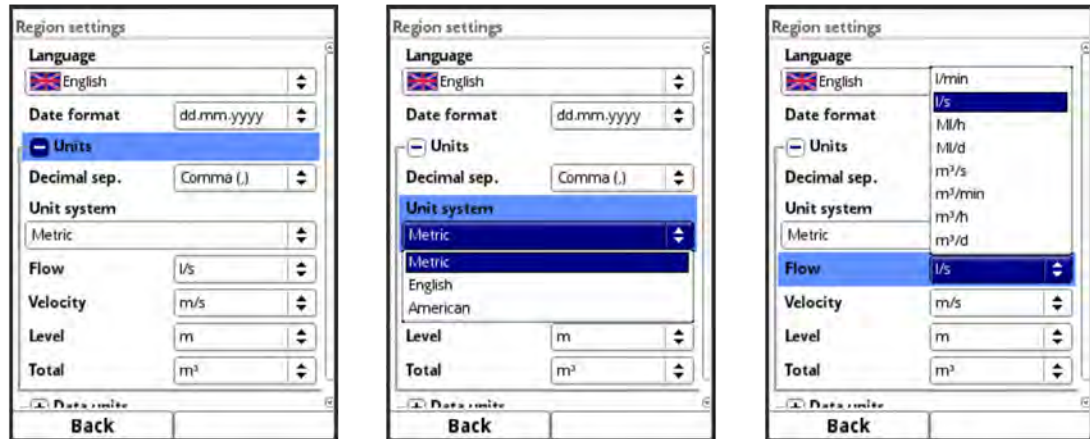

Fig. 42-3 Units System

Units System

The choices are:

- Metric
- English
- American

The adjustable units depend on the selection of the unit system:

- In the metric system - e.g. l, m³, cm/s, m³/min etc.
- In the English system - e.g. ft³, in, ft³/s, Mgal/d etc.
- In the American system - e.g. gpm, in, ft/s, mgd etc.

Units for the representation in the display for

- Flow
- Flow Velocity
- Level
- Total
- Temperature (only in unit system "English")

42.2.4 Data Units

➤ For the setting >Data Units<, proceed in exactly the same way as for the >Units<.

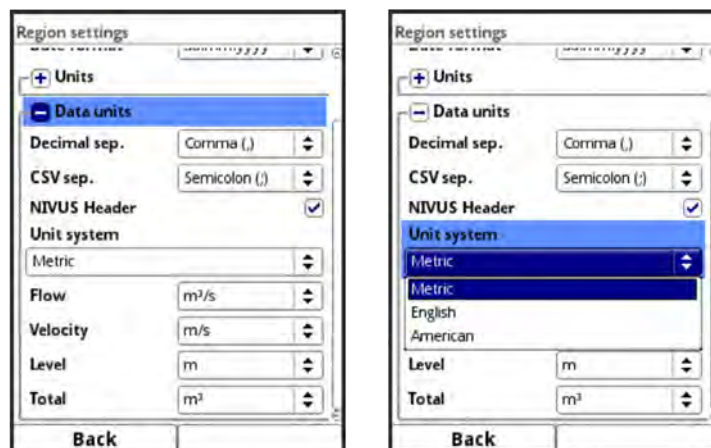

Fig. 42-4 Data Units

In **>Data Units<** the recorded measured values are **converted and stored** according to the selected unit.

>Decimal Separator<

- Comma
- Dot

The specification of the decimal separators is important for the correct reading of the data. Especially when evaluating the measurement data with a software in another language (e.g. English Excel), make sure that the decimal separators are correctly selected.

>CSV Sep.< (CSV Separator)

- Comma (,)
- Semicolon (;)

This selection determines how the individual data are separated in the .csv file when reading out the data.

>NIVUS Header<

By checking this box, you can activate the saving of the file header with the name of the measurement place, serial and article number of the transmitter as well as information on the firmware version.

Standard Excel applications as well as the NIVUS evaluation software have no problems displaying this useful additional information. If other programmes have problems reading in or evaluating the data, leave the header switched off.

>Units System<

The choices are:

- Metric
- English
- American

The adjustable units depend on the selection of the unit system:

- In the metric system - e.g. l/s, m³/s, m³/d, cm/s etc.
- In the English system - e.g. ft³/s, in, gal/min, Mgal/d, in/s, yd/s etc.
- In the American system - e.g. gps, gpm, cfs, cfm, cfh, cfd, mgd etc.

Units for the Storage of Measurement Data for

- Flow
- Flow Velocity
- Level
- Total
- Temperature (only in unit system "English")

42.3 Time/Date

In this submenu, the current date and the system time of the transmitter can be changed. The function is needed for the changeover from summer to winter time or after a failure of the internal back-up battery and after a power failure. If the transmitter is operated for a longer period of time, the internal clock may deviate. These deviations can be corrected here.



Note

Changing the system time affects the storage of the data. If data storage is activated, duplicate data or data gaps may occur after system time changes.

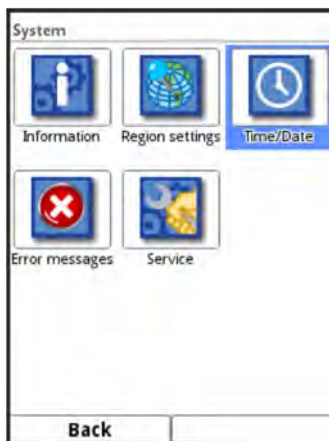

Fig. 42-5 Selecting Time/Date

Setting of the current system time and the time deviation (UTC or GMT) from the prime meridian.

In addition, the time server (SNTP) can be activated here.

This setting can only take effect with an active Internet connection.

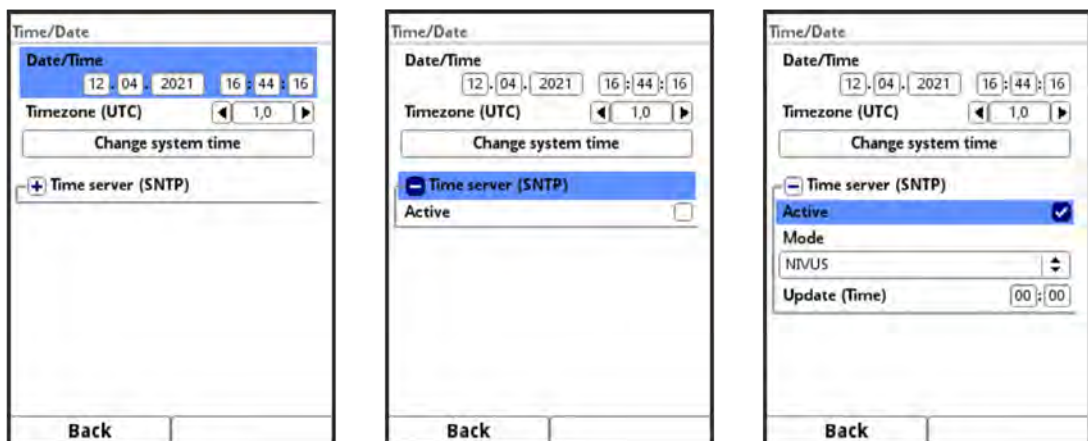

Fig. 42-6 Settings

42.4 Error Messages

In this menu, the current pending error messages and the error memory with a maximum of 32 stored (previous) errors can be called up. Moreover, the error memory can be deleted.

The data is password protected to prevent accidental deletion.

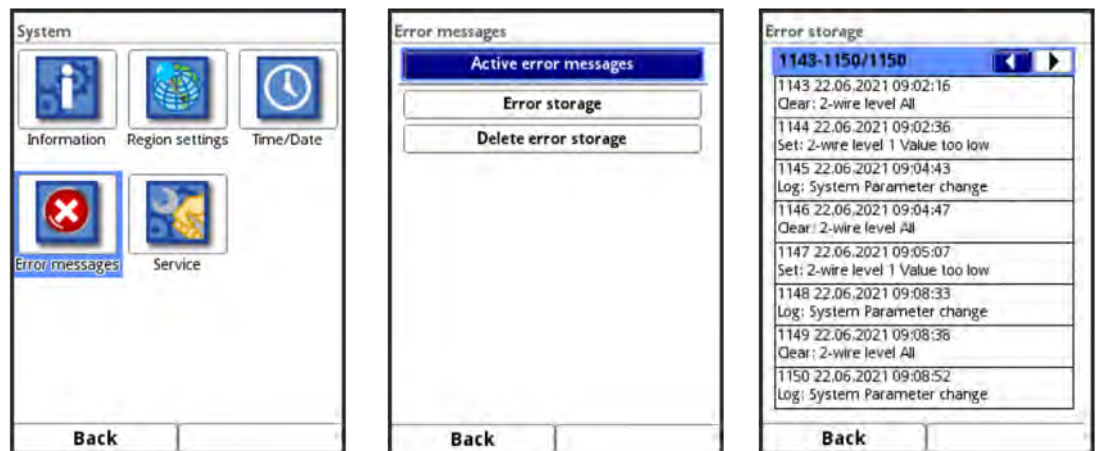

Fig. 42-7 Error Messages

42.5 Service

This submenu contains the following functions:

- Service Level
- Change Password
- Feature Unlock
- Restart (of system)
- Restart Measurement
- Parameter Reset
- Disable Coin Cell
- Update NivuFlow (only in service level with password)
- Update v-sensor (only in service level with password)
- Update h-sensor (only in service level with password)

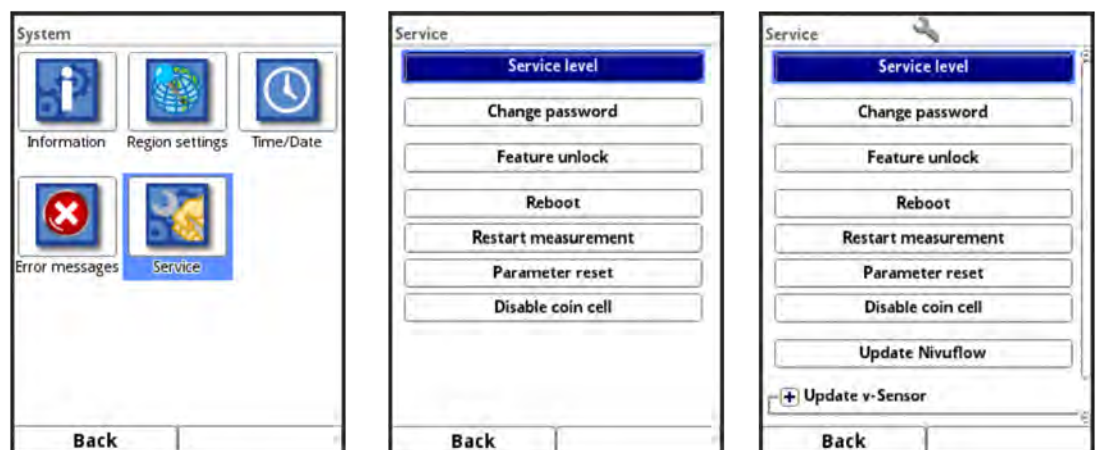

Fig. 42-8 Service

>Service Level<

Under the service level, which can be activated with the password of the transmitter, additional

functions and settings are stored in various places.

The other service levels are reserved for the NIVUS customer service and authorised specialist companies and are therefore also protected with special service passwords.

System-relevant changes and special settings for special applications are set here.

These changes may only be made by the NIVUS commissioning personnel!

42.5.1 Change (System) Password

Default setting of the password: "2718"

NIVUS recommends changing this password to protect the system from unauthorised access. The password can be chosen freely, although it is limited to ten digits.

For your own security, we recommend that you only give your password to **authorised persons**.

A password that you have changed **cannot** be recovered by NIVUS!

If the password is lost, the entire system must be reset, which leads to the loss of set parameters and requires a new parameterisation.

Write down the password and keep the note in a safe place.

➡ See also Chapter "37.2 Change Password".

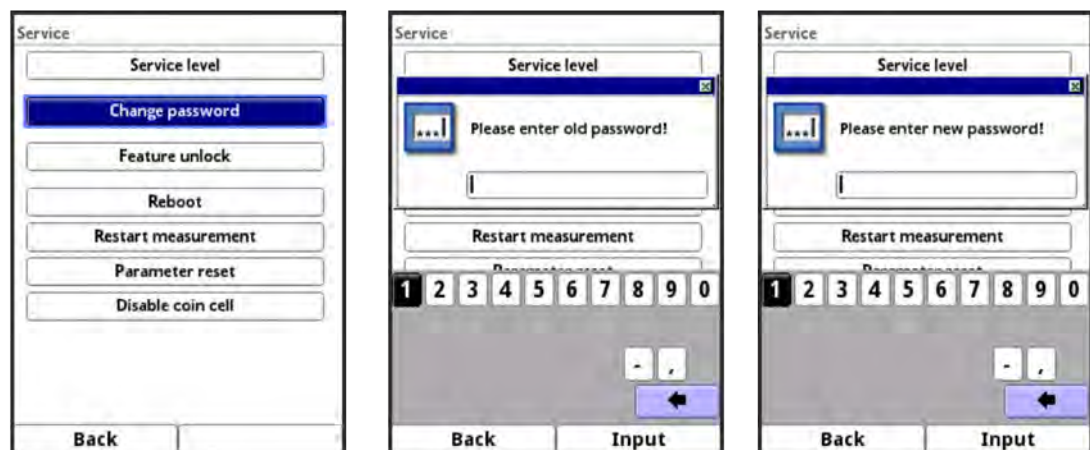

Fig. 42-9 Changing the (System) Password

42.5.2 Feature Unlock

Special (optionally available) functions can be enabled via the feature unlock, provided these have been ordered from NIVUS.

If the transmitter is ordered with a licence (ex works), it will be activated by NIVUS before delivery.



Assignment of the licence to the device unchangeable after being carried out

One licence is only valid for exactly **one device** and is permanently assigned to it through the **serial number**.

This assignment **cannot be changed** or **cannot be undone**.

Before assigning, check exactly which device must/should be linked to which licence so that the correct device also receives the licence and can use this feature.

➡ Procedure for Feature Unlock:

1. Click the >Feature Unlock< button.
2. In the opened menu click the >Feature Unlock< button.

3. Enter the function code and confirm with Input.
4. The transmitter confirms the activation of the function with "Successful". The linked licence is shown in the display.
5. The device requests a restart. Afterwards, the functions are available in the corresponding menus and can be parameterised and used.

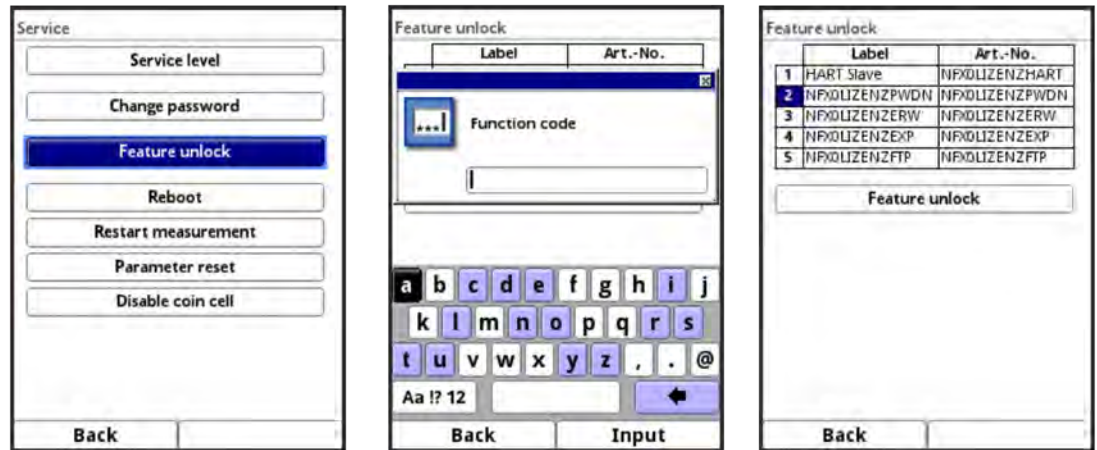

Fig. 42-10 Feature Unlock

42.5.3 Restart

A restart of the transmitter interrupts the current measurement process.

The system boots using the set (saved) parameters. After booting, the system behaves as when it is switched on (analogous to the PC).

This menu point replaces switching the system off and on again. All parameters, counters and stored data are retained.

42.5.4 Restart Measurement

When the measurement is restarted, the currently running measurement is aborted and a new measurement is started.

The transmitter holds the previous display, measurement and output values for the duration of the measurement restart and takes over the new measurement values after the measurement has been restarted successfully.

42.5.5 Parameter Reset

During parameter reset, all parameters are reset to the default settings. Counter readings, changed passwords and stored measurement data are retained in the system.

The actual resetting of the parameters is only carried out after exiting the parameterisation (back to the main menu) and confirming the storage. Until then, the process can still be cancelled.



Fig. 42-11 Resetting the Parameters to Default

42.5.6 Disable Coin Cell

Disables the coin cell (internal back-up battery in the transmitter) to save energy when the transmitter is stored.

➡ Procedure for disabling (including enabling to operate the transmitter again):

1. Click >Disable Coin Cell< and confirm the message.
2. Disconnect the unit from the mains within a few seconds (switch off the power) so that the function remains active. If the transmitter is not off the mains power for a short time, it automatically switches the function off again.



Fig. 42-12 Disable Coin Cell / Putting the Transmitter back into Operation

➡ Procedure for enabling to operate the transmitter again:

1. Connect the transmitter to mains power. The device is initialising.
2. Set the desired (operating) language via the menu.
3. Set the date, time and, if necessary, the time zone and exit.
The transmitter operates normally again.

42.5.7 Update NivuFlow

Upload of a NivuFlow firmware saved on USB.

Access possible in the service level.

Only in consultation with the companies of the NIVUS group.

42.5.8 Update h-Sensor

Upload of a sensor firmware saved on USB.

Access possible in the service level.

Only in consultation with the companies of the NIVUS group.

It is possible to update all sensors together or only individual sensors.



Fig. 42-13 Update h-Sensor (and v-Sensor)

42.5.9 Update v-Sensor

Upload of a sensor firmware saved on USB.

Access possible in the service level.

Only in consultation with the companies of the NIVUS group.

It is possible to update all sensors together or only individual sensors (Fig. 42-13).

43 Parameter Menu Communication

In this menu you can establish communication with other devices.

In addition, you can integrate the unit into a network here. Details are only partially described here.

If you do not have the necessary IT knowledge, leave this activity to either an IT specialist or the NIVUS commissioning personnel.

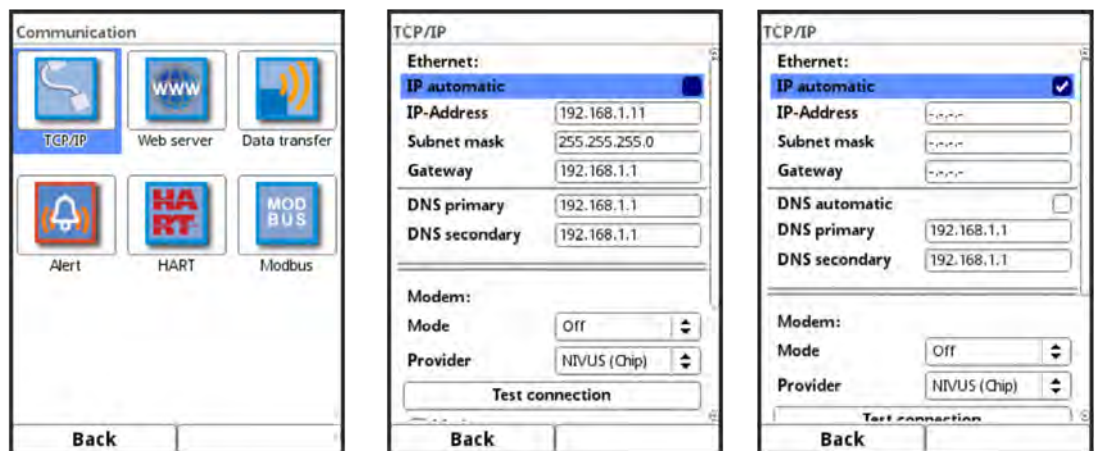

Fig. 43-1 Communication

43.1 TCP/IP

Settings for data transport in a decentralised network. Settings for the IP address and the domain are adjusted here or just displayed.

>IP automatic<:

If activated (check box), the IP address is automatically obtained from the network via DHCP; the addresses are only displayed and cannot be changed by entering them; if the function is activated, the DNS can be automatically selected in the same way.

>IP-Address<:

Address within local network

>Subnet Mask<:

Description of the local network

>Gateway<:

Router address (only if available)

>DNS<:

Addresses of the name servers for address resolution; split into primary and secondary; except if >DNS automatic< is activated, then only primary.

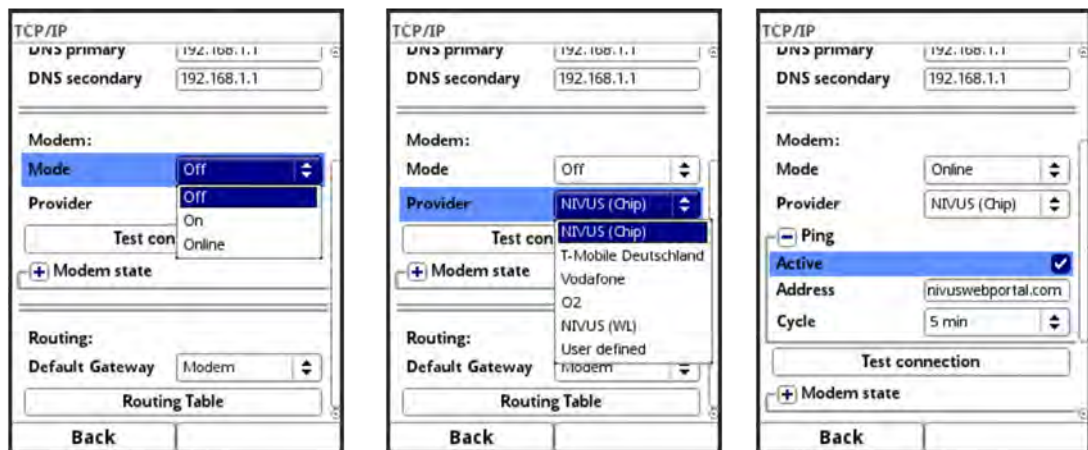

Fig. 43-2 TCP/IP with Modem

>Mode<:

Modem activation;

Select from "Off" (modem disabled), "On" (modem enabled and available) and "Online" (modem currently in use).

>Provider<:

The service via which the data connection takes place is selected here. Only one SIM card can be used at a time; there is no dual SIM function.

Currently available: NIVUS (Chip), T-Mobile Germany, Vodafone, O2, NIVUS (WL), user defined.

If "User defined" is selected, the access data of a non-preconfigured provider is entered. If necessary, this information must be requested there.

>Ping<:

Activate self-test of the modem (only with modem selection "Online").

>Test Connection<:

The modem checks existing connection options.

>Modem State<:

The information on the current status of the modem is displayed here.

>SIM Card<:

Display of information on the customer's SIM card (not with selection NIVUS (Chip)).

>Default Gateway<:

Choice of preferred path of data communication: Ethernet interface or 2G/3G/4G modem.

>Routing Table<:

The routing table indicates which path the transmitter uses to route the data packets in connected networks. This table has a static character and is defined during parameterisation. The function is necessary, for example, if Internet access is only available in the connected networks.

43.2 Web Server

The settings required for remote operation of the NivuFlow transmitter are made here. The web server makes all (operating) functions available via the Internet as an alternative to on-site operation.

The access data to the web server are defined here. The operation is then carried out remotely via a web browser using HTTP or via a data transfer programme directly via the FTP server.

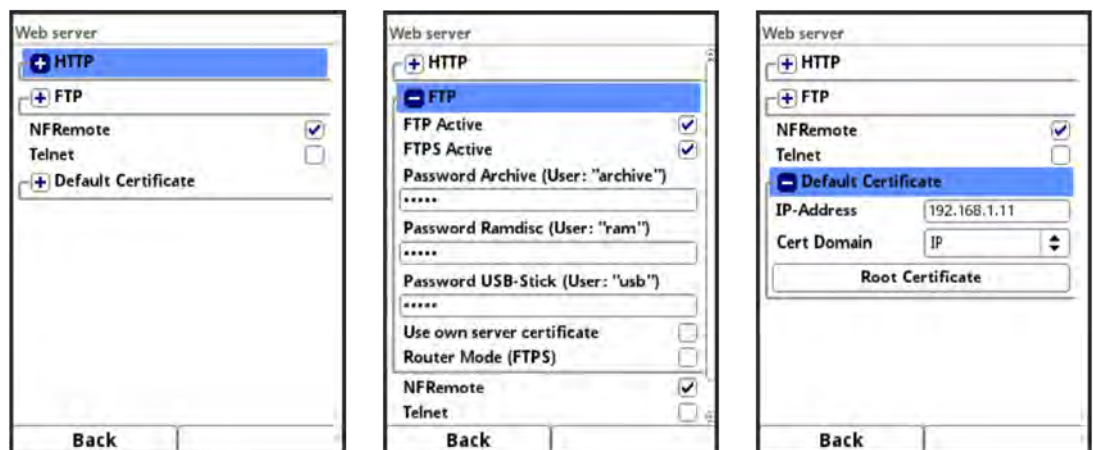

Fig. 43-3 Web Server

HTTP:

- **>HTTP Active<:**
Activation of unencrypted access via port 80
- **>HTTPS Active<:**
Activation of encrypted access via port 443
- **>Username<** and **>Password<:**
Must be set to enable access
- **>Use own Server Certificate<:**
Check box and select file

FTP:

- **>FTP Active<:**
Activation of unencrypted access via port 21
- **>FTPS Active<:**
Activation of encrypted access via port 21
- **>Password xxx<:**
Access to the various "drives" via the user name; only parameterisation of the passwords required;
Default setting: nivus
- **>Use own Server Certificate<:**
Check box and select file
- **>Router Mode (FTPS)<:**
Check and enter external IP address or corresponding ports (Port Start / Port Num);
special FTP mode for TLS via router
Condition: the parameters set in the transmitter and in the router match.

NF Remote:

- **>NF Remote<:**
Allow remote access by NIVUS

Telnet:

- **>Telnet<:**
Allow remote access via Telnet

Standard Certificate:

- **>Standard Certificate<:**
Enter / change the certificate used; enter/select IP address and domain type (IP / name) or load >Root Certificate< from USB stick;
the device has its own certificate, but can load a third-party certificate via the USB port if required.

43.3 Data Transmission

The automated cyclical data transmission to the NIVUS WebPortal is defined here. This can be done via the network protocol MQTT, via FTP server or via e-mail.

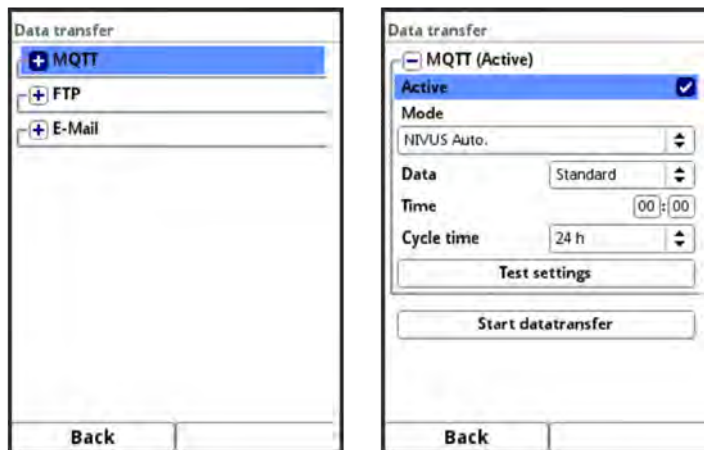

Fig. 43-4 Data Transmission Options / MQTT

MQTT:

The NIVUS WebPortal is pre-configured and available to the user with a chargeable booking. It offers a wide range of options for data display, measurement place visualisation, reporting and analyses.

As an option, the MQTT network protocol is available. This protocol is used to send all data that accumulates in the data memory to an MQTT server.

- **>Active<:**
Check the box to activate.
- **>Mode<:**
 - **>NIVUS Auto.<:**
The system automatically selects whether the data is sent via Ethernet or via the 2G/3G/4G modem.
 - **>NIVUS Ethernet<:**
Transmits data via Ethernet.
 - **>NIVUS Modem<:**
Transmits data using the 2G/3G/4G modem.
 - **>User Defined<:**
>Modem<:
The MQTT server is reached exclusively via the 2G/3G/4G modem.

>Broker<:

The Internet address of the server is entered either as a host name or IP address.

>Port<:

Associated port

>Encryption<:

Activation of secure (SSL/TLS) communication between client and server and use of the port.

>User Name< and >Password<:

Authentication of the transmitter.

- **>Data<:**
Determination of the data depth to be transmitted (see also Chap. "41.4 USB Stick").
 - **>Standard<:**
Basic data
 - **>Extended<:**
Extended data package (available only through bookable licences; see Chap. "18.2 Add-On Function Licences")
 - **>Expert<:**
Maximum data package (available only through bookable licences; see Chap. "18.2 Add-On Function Licences")
- **>Time<:**
Time of first transmission; individual entry via rotary pushbutton.
- **>Cycle Time<:**
Time until next data transmission; Options: 2 min, 5 min, 10 min, 15 min, 30 min, 1 h, 2 h, 3 h, 4 h, 6 h, 8 h, 12 h and 24 h.
- **>Test Settings<:**
Establish a test connection to the server with the specified values.
- **>Start Data Transfer<:**
Manual data transmission since the last transmitted time stamp.

FTP:

Transmission to a customer FTP server or to the D2W data portal.

Available as an additional function licence (see Chap. "18.2 Add-On Function Licences" and "42.5.2 Feature Unlock").

Option is available only when MQTT is inactive.

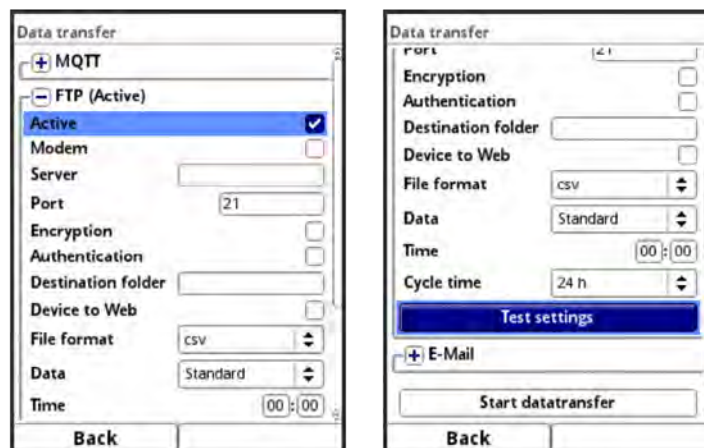

Fig. 43-5 Data Transmission via FTP

- **>Active<:**
Check the box to activate.
- **>Modem<:**
Check box to activate (online) the internal modem before the actual transmission.
- **>Server<:**
Specify server name or IP address.
- **>Port<:**
Associated port
- **>Encryption<:**
Activation of secure (SSL/TLS) communication between client and server and use of the port.
- **>Authentication<:**
Activate with user and password-protected FTP access and specify in user and password.
- **>Destination Folder<:**
Enter the destination folder where the files are to be stored.
- **>Device to Web<:**
Activate when transmitting to the D2W; the Device-to-Web compatible format is applied.
- **>File Format<:**
There are csv and txt available.
- **>Data<:**
Determination of the data depth to be transmitted (see also Chap. "41.4 USB Stick").
 - **>Standard<:**
Basic data
 - **>Extended<:**
Extended data package (available only via additional licences; see Chap. "18.2 Add-On Function Licences")
 - **>Expert<:**
Maximum data package (available only via additional licences; see Chap. "18.2 Add-On Function Licences")
- **>Time<:**
Time of first transmission; individual entry via rotary pushbutton.
- **>Cycle Time<:**
Time until next data transmission; Options: 2 min, 5 min, 10 min, 15 min, 30 min, 1 h, 2 h, 3 h, 4 h, 6 h, 8 h, 12 h and 24 h.
- **>Test Settings<:**
Establish a test connection to the server with the specified values.
- **>Start Data Transfer<:**
Manual data transmission since the last transmitted time stamp.

E-Mail:

Transmission to an e-mail address.

Available as an additional function licence (see Chap. "18.2 Add-On Function Licences" and "42.5.2 Feature Unlock").

Option is available only when MQTT is inactive.

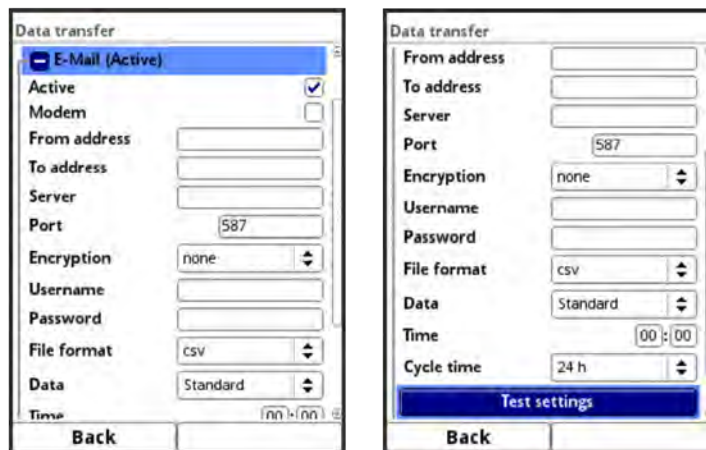

Fig. 43-6 Data Transmission via E-Mail

- **>Active<:**
Check the box to activate.
- **>Modem<:**
Check box to activate (online) the internal modem before the actual transmission.
- **>From Address<:**
E-Mail sender address (needs to be accepted by the SMTP server).
- **>To Address<:**
E-Mail destination address.
- **>Server<:**
Specify server name or IP address.
- **>Port<:**
Associated port
- **>Encryption<:**
An encryption via STARTTLS or SSL can be selected optionally.
- **>User Name<:**
Enter the user name of the e-mail box.
- **>Password<:**
Enter the password of the e-mail box.
- **>File Format<:**
There are csv and txt available.
- **>Data<:**
Determination of the data depth to be transmitted (see also Chap. "41.4 USB Stick").
 - **>Standard<:**
Basic data
 - **>Extended<:**
Extended data package (available only via additional licences; see Chap. "18.2 Add-On Function Licences")
 - **>Expert<:**
Maximum data package (available only via additional licences; see Chap. "18.2 Add-On Function Licences")
- **>Time<:**
Time of first transmission; individual entry via rotary pushbutton.

- **>Cycle Time<:**
Time until next data transmission; Options: 2 min, 5 min, 10 min, 15 min, 30 min, 1 h, 2 h, 3 h, 4 h, 6 h, 8 h, 12 h and 24 h.
- **>Test Settings<:**
Establish a test connection to the server with the specified values.
- **>Start Data Transfer<:**
Manual data transmission since the last transmitted time stamp.

43.4 Alert

The >Alert< parameter menu is divided into various sub-items. These sub-items are >Flow<, >Level<, >Velocity<, >Water Temperature<, >Air Temperature<, >Analogue Input x< and >Digital Input x< ("x" here is a placeholder, the respective number depends on the type-related number of available analogue and digital inputs).

All sub-items are only visible if the analogue and digital inputs have previously been assigned a type under >Application< and thus activated.

➡ See Chap. "39.4.1 Analogue Inputs" and "39.4.3 Digital Inputs".

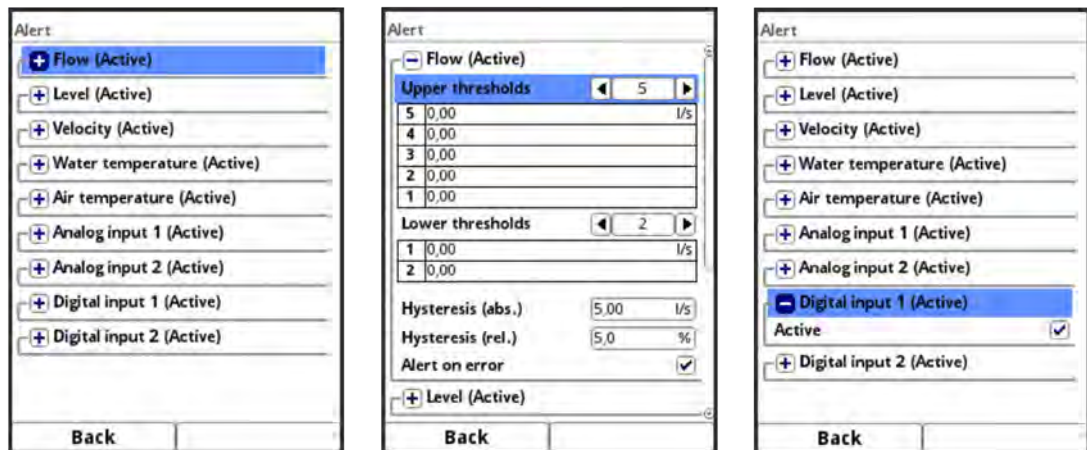

Fig. 43-7 Alert menu

For all sub-items (except >Digital input<), up to five different threshold values can be entered via the rotary pushbutton for **>Upper Thresholds<** and for **>Lower Thresholds<**. When these are reached, an alarm e-mail (only in connection with the NIVUS WebPortal) is to be issued.

The threshold values are defined by clicking on the fields and typing in numerical values. The transmitter sorts the entered threshold values in descending order. This is done independently of the input sequence.

For **>Hysteresis (abs.)<** and **>Hysteresis (rel.)<** values can be entered by clicking and typing. The transmitter evaluates the two values and sends an e-mail (only in connection with the NIVUS WebPortal) at the highest downwards limit (lowest possible value). This e-mail contains the information that the alert has been cancelled.

In addition, the checkbox **>Alert on error<** can be set. Then an alarm e-mail (only in connection with the NIVUS WebPortal) is sent in the event of an active pending error. Such errors are e.g. cable faults, interruptions, short circuits etc.



Check >Alert on error< box

NIVUS recommend checking this box to receive an alarm e-mail if a flow velocity sensor is defective. A defect in the flow velocity sensor will cause the flow measurement to fail.

In the sub-item **>Digital Input x<** a check mark can be set to activate an alarm e-mail (only in connection with the NIVUS WebPortal) when a digital "high" occurs at the digital input.

Default setting: box unchecked.

43.5 HART (function can be added via licence)

The functionality of the communication via HART must be purchased via the additional function licence and this function licence must then be activated.

If the transmitter is ordered with a licence (ex works), it will be activated by NIVUS before delivery.

➡ See also Chap. "18.2 Add-On Function Licences" and "42.5.2 Feature Unlock".

When communicating via HART (via AO1), the identification data of the connected device must be entered.

Fig. 43-8 HART

43.6 Modbus

The transmitter can be integrated into other systems via Modbus.

If required, the Modbus protocol (see Chap. "1.1 Applicable documentation") can be sent to you on request. For this purpose, please contact the technical office staff at the head office of NIVUS GmbH in Eppingen.

Alternatively, the document is available for download in the download centre on our homepage.

Fig. 43-9 Modbus

The following functions are available here:

- Slave address (1 to 247)
- TCP (Port)
- RTU
 - Interface (RS232 or RS485)
 - Baud rate (1200, 2400, 4800, 9600, 19200, 38400, 57600 or 115200 Baud)
 - Parity (None, Odd or Even)
 - Stop bits (1 or 2)

Furthermore, the following scalings can be set:

- Scaling Flow
- Scaling Level
- Scaling Velocity
- Scaling Temperature
- Scaling Area
- Scaling Analogue
- Scaling Total

By entering the values for 0 / 65,535 digits (or -32,768 / 32,768 if Signed is ticked), the resolution of the measuring range is set.

A value must be entered for "Error Value (digits)" (factory setting: "0") in order to communicate an error message when an error occurs.

Under >Scaling Total< only one value is entered for "Scaling/digit".



Expert knowledge required

These settings require extensive expert knowledge and require the use of NIVUS commissioning personnel or an authorised specialist company.

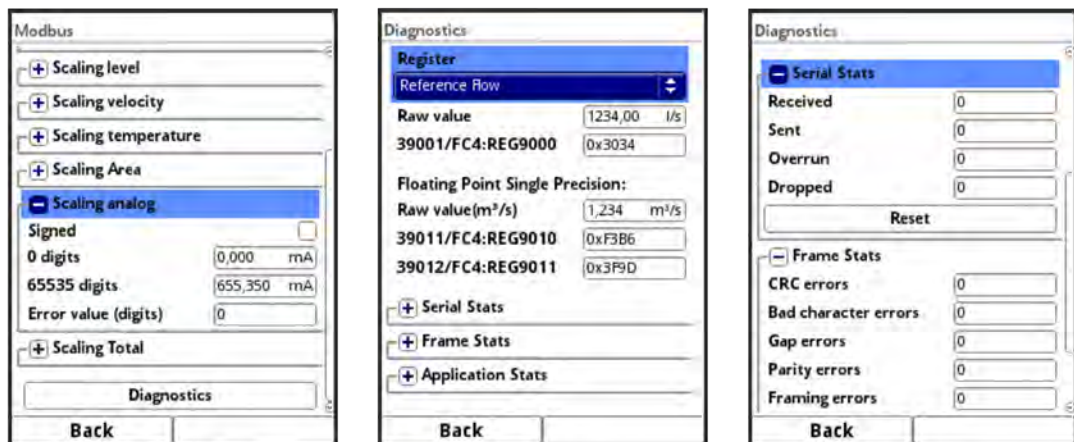

Fig. 43-10 Setting Parameters Scaling / Diagnostics / Serial Stats

Under >**Diagnostics**< the individual registers (flow reference, total reference, flow, level, velocity, water temperature and air temperature) can be viewed in more detail.

The **raw value** and the assignment of the Modbus registers are displayed at the same time. Fixed values can be entered to adjust the scaling/transmission sequence between the transmitter and the connected Scada/PLC.

The statistics (Serial Stats, Frame Stats and Application Stats) are arranged in layers. After viewing, a reset is possible in each case.

Serial Stats concern the serial interfaces (not when accessed via Modbus TCP) and inform about the number of bytes received, sent and discarded/lost.

Frame Stats are about the communication frame and inform about error sources such as the sequence of bytes, checksums, parity, valid packets and other errors.

The **Application Stats** concern the application level and inform about functional errors such as unsuccessful transmissions, unsupported function codes, unoccupied data addresses and other errors.

44 Parameter Menu Display

The following changes can be made in the display menu:

- Backlight (intensity)
- Lockscreen, Dim backlight and Switch off display (period until switch-off)
- Advance Main Display (only for NivuFlow 750 Type M9 with multiple measurement places)
- Labelling of the five display fields of the main display
- Decimal places of the individual value representations

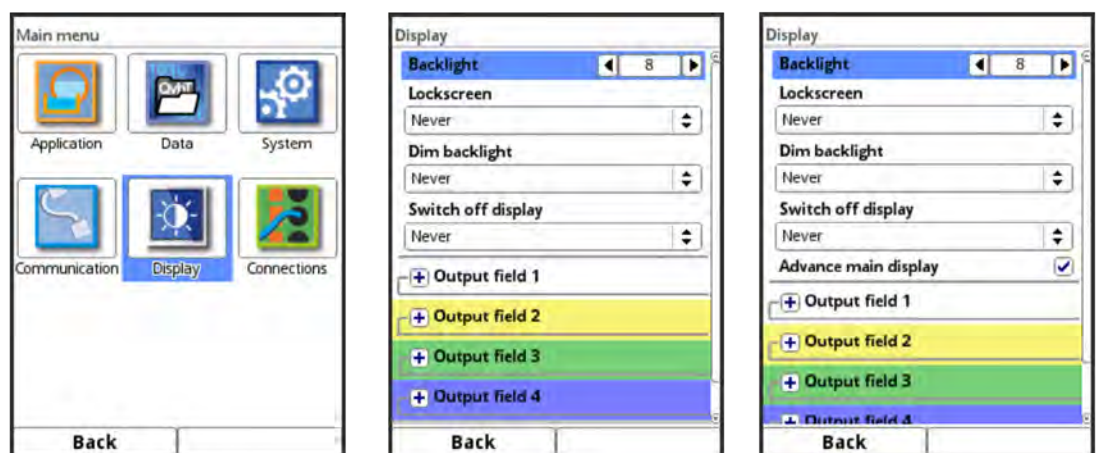

Fig. 44-1 Display/Backlight/Delay Time

Backlight

You can change the backlight in ten levels.

Adjust the backlight to the ambient conditions. Avoid setting the display too brightly.

NIVUS recommends setting the automatic display dimming / **Dim backlight** or display switch-off here to protect the display and extend its service life.

The display switches off automatically if you have not used it for a certain time. You can define this time via the delay time / **Switch off display** (Never, 30 s, 1 min, 2 min and 5 min).

As soon as you make any setting on the transmitter (e.g. press a key), the display immediately switches back to the standard brightness.

If you want to ensure that the transmitter display can only be reactivated by authorised persons, use the **>Lockscreen<** function. Then the password for the transmitter must be entered before the display can be used again.

Default settings: >Backlight< on level „8“, >Lockscreen<, >Dim backlight< and >Switch off display< = "Never".

Advance Main Display (only for NivuFlow 750 Type M9 with multiple measurement places)

If the box is checked here, the main display automatically switches back and forth between the activated measuring points for Type M9 with multiple measurement places. Each measurement place or its current values are displayed for approx. 5 s without further settings.

If the check mark is not set, the main display remains at the last measurement place displayed. By pressing the tab key, the display can be advanced to the desired measurement place. The measuring point to which the displayed values apply is indicated in the main display by the measurement place name in the upper left corner or the dark number in the upper right corner (in "tab mode"):

- 1 = Measurement Place MP1
- 2 = Measurement Place MP2
- 3 = Measurement Place MP3
- 4 = Combi Measurement Place

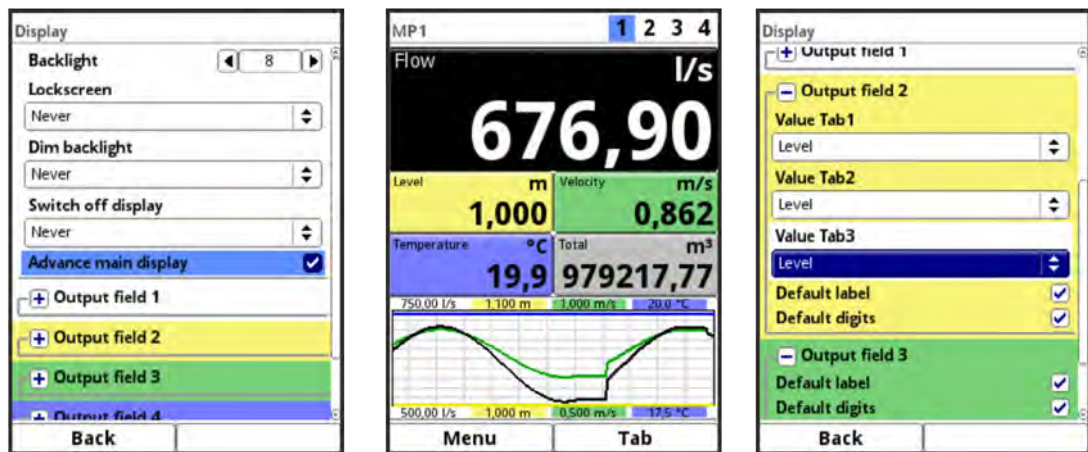

Fig. 44-2 Advance Main Display / Output Fields: assign value

Output Fields

The output fields 1...5 on the main display (flow, level, (wetted hydraulic) surface, analogue output X, medium temperature, air temperature, totals, daily average level, velocity, temperature and total) can be freely defined in terms of designation and decimal places.

For the output fields 2, 4 and 5, you can also select under >Value< which value should actually be displayed.

The options are:

- Output field 2:
"Level", "Area" (= calculated, hydraulically wetted area of the application), "Analogue input 1", "Analogue input 2" (etc.; depending on type and number of AIs) and "Not active"
- Output field 4:
"Area", "Water temperature", "Air temperature" (only possible when using an air-ultrasonic sensor, type LUS), "Total", "Total positive", "Total negative", "Daily average", "Daily average pos.", "Daily average neg.", "Analogue input 1", "Analogue input 2" (etc.; depending on type and number of AIs) and "Not active"
- Output field 5:
"Area", "Total positive", "Total negative", "Daily average", "Daily average pos.", "Daily average neg.", "Analogue input 1", "Analogue input 2" (etc.; depending on type and number of AIs) and "Not active"

Special feature when using a NivuFlow transmitter 750, **Type M9 with multiple measurement places**: here, the display can be set separately for each measurement place MPx. To do this, open the pull-down menus of the individual output fields at >Value Tab1<, >Value Tab2<, >Value Tab3< and >Value Tab4< and select the desired designation.

The respective "TabX" corresponds to the number at the top right of the main display when advancing is activated.

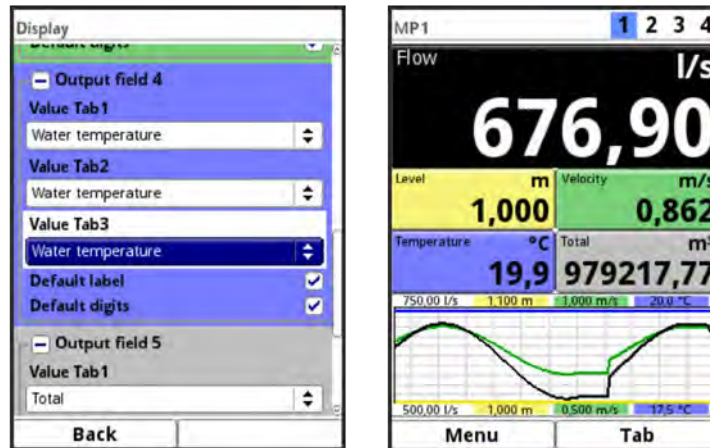

Fig. 44-3 Defie Output Fields in case of Multiple Measurement Places / Main Display



Note

The assignment of the values to the fields can NOT be changed in output fields 1 and 3. The change can only be made in the output fields 2, 4 and 5 by selecting "Value" or "Value TabX".

Example: The flow rate is ALWAYS output in the flow field (output field 1), even if you have changed the designation to "Temperature".

The highlighted colours of the output fields correspond to the colours of the values in the main display.

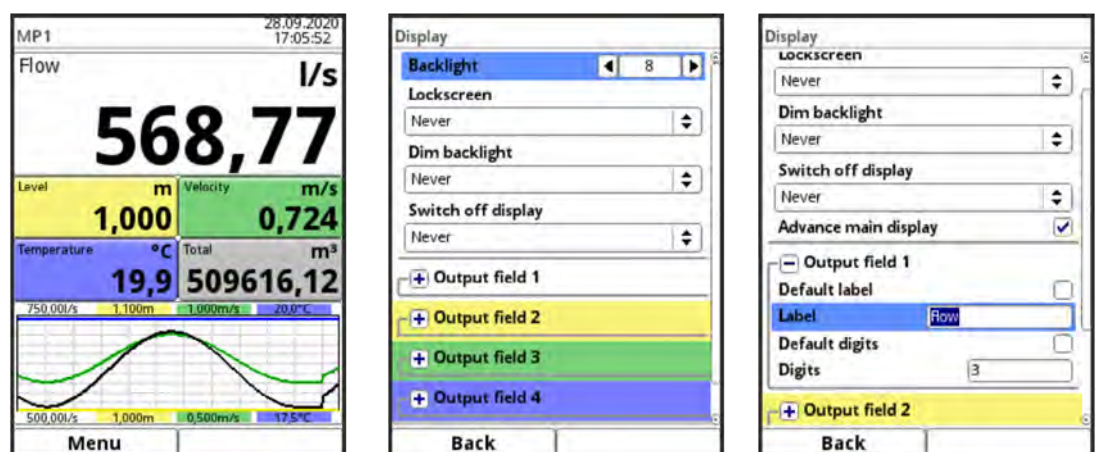

Fig. 44-4 Change Output Fields, Colours and Designation

➡ Procedure to change the **Label**:

1. Expand the output field.
2. Uncheck the >Default label< box.
3. Enter a new name. This designation is freely selectable, but the number of characters is limited to 16.

The label name you enter does **not** change the value of the fields in the main display.

The desired number of **decimal places** can be entered in the same way. A maximum of five decimal places is possible.



Observe the measurement accuracy of the sensors

When setting the decimal places, observe the measuring accuracies of the sensors and the set units of measurement.

The temperature sensor, for example, can only resolve in a 0.1 K grid.

45 Parameter Menu Connections

45.1 Common

This submenu is required if sensors are not connected directly to the transmitter but via the Ex Separation Module Type iXT or the multiplexer MPX.

45.2 For Transmitters Types S1, SR and M3

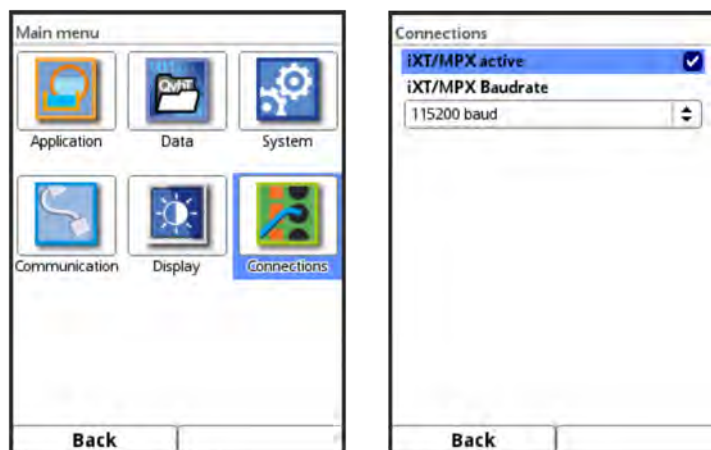

Fig. 45-1 Selecting Connections / Activation / Baud Rate

Check the box when using iXT or MPX together with Types S1, SR and M3. Otherwise the sensor and iXT/MPX will not be recognised by the transmitter.

45.3 For Transmitters Type M9

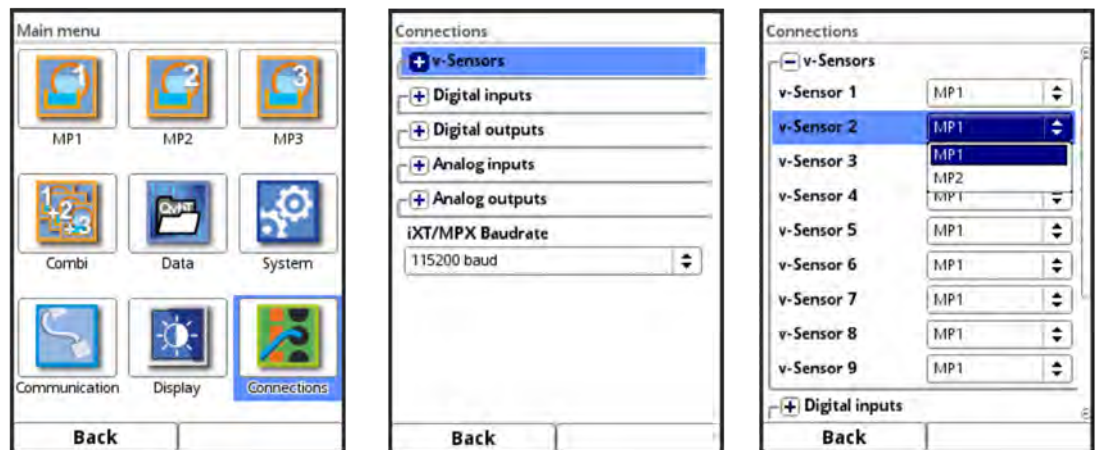

Fig. 45-2 Assignment with NivuFlow 750 Type M9

For NivuFlow 750 Type M9 transmitters with multiple measurement places, the individual flow velocity sensors (v-sensors) and the inputs/outputs must be assigned to the respective measurement places. The prerequisite for this is that the measurement places have been activated before (tick >Active<).

When **assigning the flow velocity sensors**, there is a fixed sequence that must be followed. The assignment always starts with v-sensor 1 and is done in ascending order.

Application Example:

v-sensors 1, 2, 3 and 4 to measurement place MP1

v-sensors 5 and 6 to measurement place MP2

v-sensors 7, 8 and 9 to measurement place MP3

Here it is not possible to assign the higher numbered sensors to a lower numbered measuring point: v-sensor 8 or 9 to MP1 or 2 is not possible.



See also Chap. "25 Special Functions NivuFlow 750 Type M9".



Procedure:

1. Open the >Connections< menu.
2. Expand >v-Sensors< and assign them, starting with v-sensor 1, from top to bottom to the respective measuring point MPx.
To avoid incorrect parameter settings, it is only ever possible to select the (numerically) next higher measuring point. If a v-sensor (in the following example v-sensor 5; Fig. 45-3 screens 1...3) is assigned to measurement place MP2, after confirmation all subsequent sensors are immediately also set to measurement place MP2 and can now alternatively only be assigned to measurement place MP3. If this is carried out with v-sensor 7 - as shown in the following example (Fig. 45-3 screens 4...5) - v-sensors 8 and 9 are also automatically set to measurement place MP3 and can no longer be assigned to any previous measurement places.

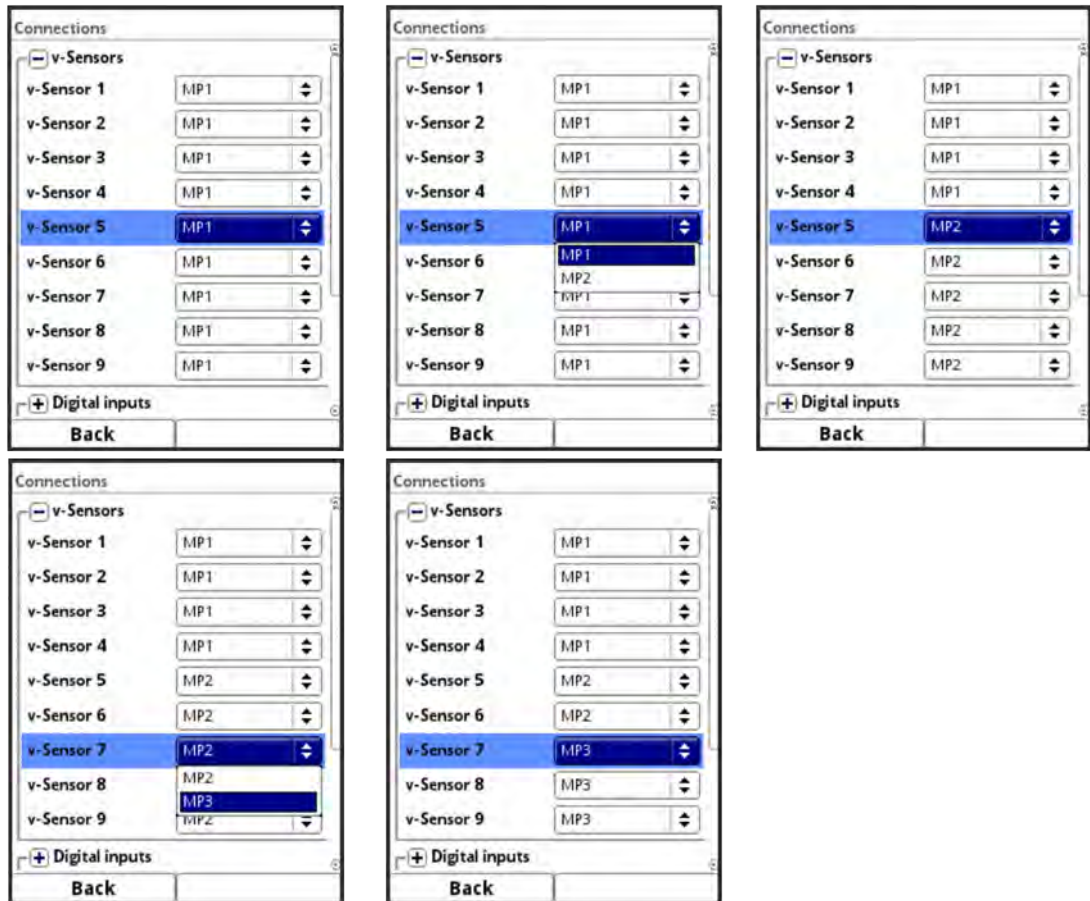
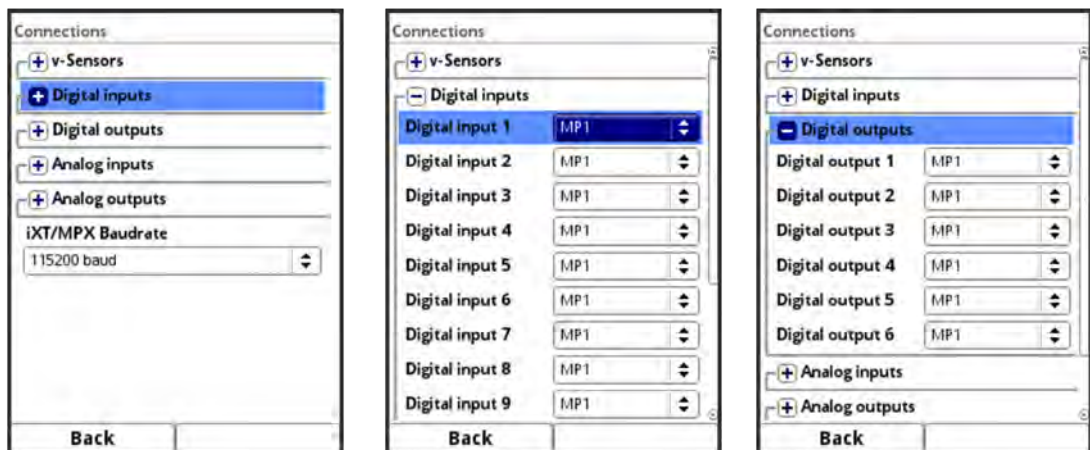

Fig. 45-3 Assignment Examples v-Sensors

When **assigning the inputs/outputs**, the order is arbitrary. All inputs/outputs can be assigned to the measurement places MPx unordered and mixed.



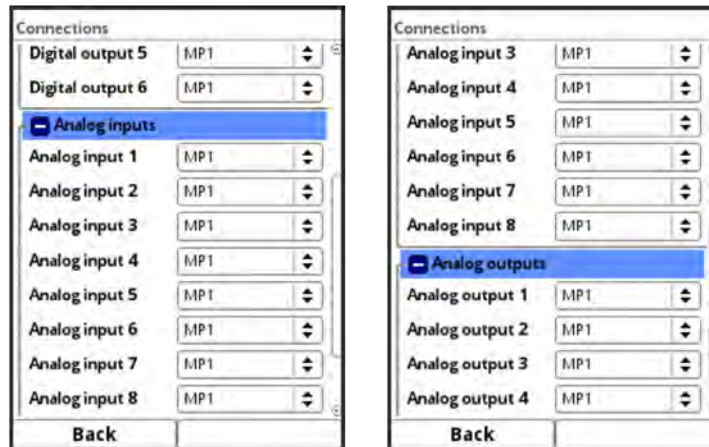

Fig. 45-4 Assignment Examples Inputs/Outputs

Furthermore, it is possible to assign inputs and outputs to the virtual combi measurement place (Combi). For example, an analogue input for the consideration of an external flow measurement as a fourth measurement place and/or an analogue output for the output of the total flow.



Fig. 45-5 Assigning Inputs/Outputs to the Combi Measurement Place

- ➡ After assigning the inputs and outputs to the corresponding measurement places, the final parameterisation of the individual measurement places is carried out according to Chap. "39 Parameter Description".

45.4 Baud Rate (all Types)

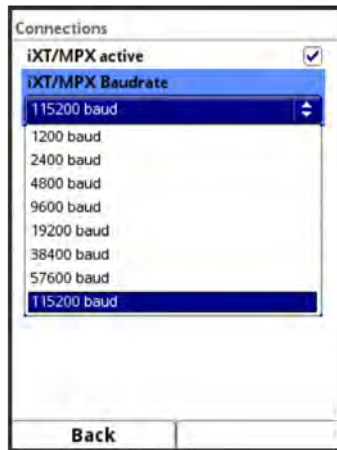

Fig. 45-6 Baud Rate

For all types, it is possible to change the **>Baud Rate<** here.

Default setting: 115200 Baud.

CAUTION



Do not modify the baud rate

Change the baud rate only after consultation with the NIVUS customer service.

Reduced baud rates make transmission more reliable, but slow down the response speed of the entire measurement system.

Diagnostics

46 Basics of the Diagnostics Menu



Fig. 46-1 Menu Diagnostics

The menu >Diagnostics< can be found in the >Application< menu. Diagnostics is divided into up to six submenus (six if the controller is activated).

The Diagnostics menu and all submenus are purely display and simulation menus. There is no parameterisation possible within the menu.

In this section, the following settings can be checked or simulated:

- **h-Sensors:**
Level currently used for calculation, the levels determined by the individual connected and parameterised level sensors as well as their adjustment heights.
Serial number, firmware version, echo profile and temperature of the i-Sensor.
Raw value, calibrated value and value used for calculation as well as firmware version, serial number, article number, echo profile and signal noise values of the water-ultrasonic sensor.
Raw value, calibrated value and value of the integrated pressure sensor used for calculation.
- **v-Sensors:**
Article numbers, firmware versions, serial numbers, determined average velocities, graphical velocity profile, tabular representation of the individual velocities and their height position, 3D animation of the prevailing velocity profile as well as various quality parameters of the measurement.
- **Inputs and Outputs:**
Status and (partly) simulation of the analogue and digital inputs and outputs.
- **Q-Regler:**
Indication of the current controller status, the currently prevailing flow value and level, setpoint used, deviation between setpoint and actual value, sampling time of the control algorithm, slider running time, error delay and the states of the programmed digital inputs for control operation.
- **Flow profile:**
3D animation of the prevailing velocity profile in different views.
- **Simulation:**
Access to and change option for all internally recorded and calculated values such as level, velocity and flow as well as to the digital and analogue signal outputs.



Important Note

It is essential to follow the safety instructions for the simulation in page 191.

47 Diagnostics h-Sensors

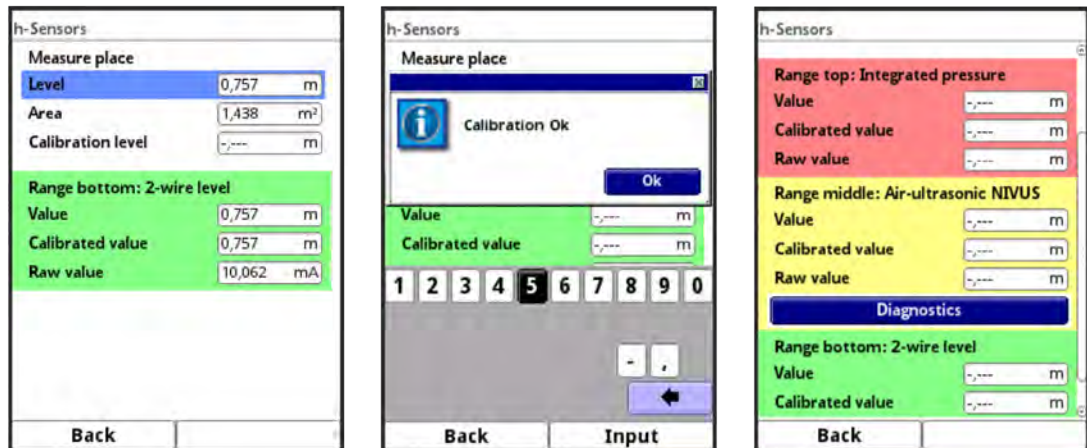

Fig. 47-1 Menu Diagnostics h-Sensors

This menu works in conjunction with the >Applications< / >h-Sensors< menu. Depending on the type and number of sensors defined there, 1...3 areas are displayed in colour.



See Chapter "39.2 Setting Parameters in Menu h-Sensors".

In >Diagnostics h-Sensors<, the current level and the currently wetted area, calculated on the basis of the channel shape/dimensions entered, are displayed unchangeably. The adjustment height can be set and is also confirmed with OK after entry (Fig. 47-1). The adjustment height corresponds to the offset and is usually specified when the h-sensors parameters are set. Depending on which sensors are selected, the value, the calibrated value or the raw value is displayed.

- **Value:** output value used for calculation
- **Calibrated Value:** corrected, used value
- **Raw value:** value actually measured by the sensor

For the sensor types "Water-Ultrasound integrated" and "i-Sensor", it is possible to obtain information on firmware version, serial and article number, various quality parameters of the measurement as well as the graphically displayed echo signal after pressing the button "Diagnostics".

With the i-sensor connected via HART, the prevailing sensor temperature (usually corresponding to the ambient temperature) can also be read and the sensor can be changed or reset in some sensor parameters.



Special Knowledge required

This function requires extensive knowledge in the application evaluation of the ultrasonic signal and should only be carried out by NIVUS service or by companies authorised by NIVUS.

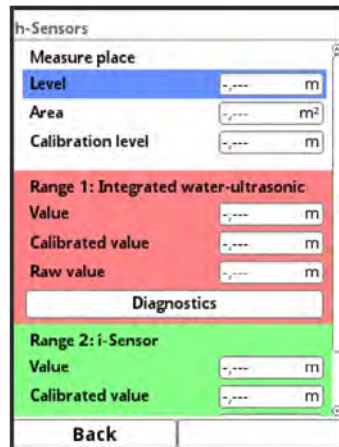

Fig. 47-2 Water-Ultrasonic Sensor

48 Diagnostics v-Sensors

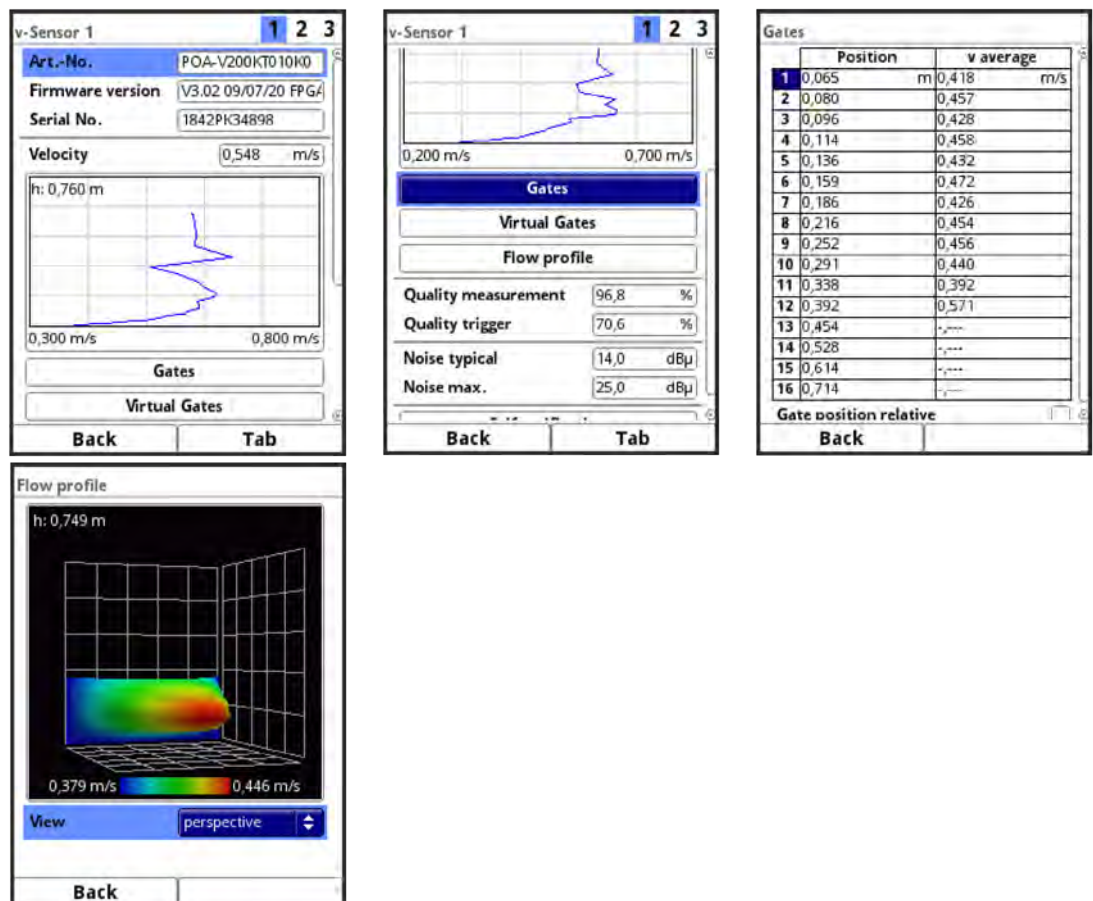

Fig. 48-1 Menu Diagnostics v-Sensors

In this menu, hardware information and current data on the sensors can be displayed (see Fig. 48-1).

In detail these are:

- Article number, firmware version and serial number (important for customer service in case of queries)
- Calculated average velocity
- Gates and virtual gates

- Flow profile
 - perspective
 - top
 - front
 - Side
- Quality Measurement and trigger
- Noise typical and maximum

The right function key (Tab) can be used to jump between the sensors.

The individual measured velocities and the corresponding filling levels can be displayed in tabular form:

- Rotate the rotary pushbutton until the field >Gates< is highlighted blue.
- Press the rotary pushbutton - the current information is displayed in tabular form.

Gates

	Position	v average
1	0,065 m	0,418 m/s
2	0,080	0,457
3	0,096	0,428
4	0,114	0,458
5	0,136	0,432
6	0,159	0,472
7	0,186	0,426
8	0,216	0,454
9	0,252	0,456
10	0,291	0,440
11	0,338	0,392
12	0,392	0,571
13	0,454	-
14	0,528	-
15	0,614	-
16	0,714	-

Gate position relative

Back

Fig. 48-2 Gates

Here, the average height of the measured velocity gate, related to the 0-point of the application, is displayed in the "Position" column.

The column "v-average" contains the value of the corresponding measured and damped average velocity.

By checking >Gate Position Relative<, the gate positions are only displayed in relation to the flow velocity sensor, regardless of the installation angle, installation position and installation height of the sensor.



Short time delay by switching the relative position

The calculated new gate position changes immediately by switching the relative position. The individual flow velocities cannot follow immediately due to damping and required minimum amounts of information in the signal evaluation.

Wait approx. 30...60 seconds before reading the individual velocities.

Deviating display conditions in the gates table:

- Due to a minimum gate length required for signal purposes, 16 gates cannot be displayed for applications with **lower filling levels**. Therefore, in these cases, it is possible that the total number of gates in the table will be reduced.

- Velocities
 - directly **below the water surface**,
 - within the **block distance** ("dead zone") in front of the sensors and
 - **underneath the installation position** of the sound transducer in the sensor body

cannot be determined by measurement and therefore cannot be presented here in tabular form.

Virtual Gates

Virtual Gates			
	Position	v virtual	v average
1	0,007 m	0,258 m/s	-
2	0,014	0,294	-
3	0,022	0,315	-
4	0,029	0,330	-
5	0,036	0,342	-
6	0,043	0,351	-
7	0,051	0,359	-
8	0,058	0,366	-
9	0,065	0,396	0,396
10	0,080	0,382	0,382
11	0,096	0,371	0,371
12	0,114	0,373	0,373
13	0,136	0,391	0,391
14	0,160	0,448	0,448
15	0,187	0,466	0,466
16	0,217	0,423	0,423
17	0,253	0,490	0,490

Virtual Gates			
15	0,188	0,562	0,562
16	0,219	0,603	0,603
17	0,255	0,626	0,626
18	0,295	0,663	0,663
19	0,343	0,638	0,638
20	0,397	0,593	0,593
21	0,461	0,616	0,614
22	0,536	0,647	0,655
23	0,623	0,630	-
24	0,638	0,626	-
25	0,653	0,626	-
26	0,667	0,625	-
27	0,682	0,625	-
28	0,697	0,625	-
29	0,712	0,624	-
30	0,726	0,624	-
31	0,741	0,623	-
32	-	-	-

Fig. 48-3 Virtual Gates

When selecting and displaying virtual gates, a maximum of 32 gates are displayed. That is 8 calculated gates above the maximum measurable gate up to the measured water surface and 8 calculated gates below the last measurable gate up to the parameterised 0-point of the channel/pipe. The other, maximum 16, measurable gates are located between the two calculated gate areas.

If the level in the application is too low, it is not possible to measure 16 gates. In this case, the 32 gates are reduced by the number of gates that cannot be measured. The number of the 8 calculated gates above and below the measurable range remains constant. If there are invalid gates within the measurable range, they are replaced by the same integrated mathematical model that calculates the gates above and below the measurable range.

The 8 calculated gates above and below the measurement range are divided symmetrically. The positions of the measurable gates are subject to a mathematical algorithm.

The flow profile is calculated according to internal hydraulic methods.

The following factors are included in this calculation of the flow profile:

- Individual velocities
- Individual heights
- Channel profile
- Channel dimensions

The display can be switched between front view, top view, front view, side view or a perspective view. The values are scaled automatically.

Anomalies in the velocity distribution can only be plausibly visualised when using more than one flow velocity sensor at a flow measurement point. With their use, horizontal hydraulic disturbances also become visible.

This 3D animation is therefore particularly useful when using multiple v-sensors (only for NivuFlow 750 Type M3/M9). In structured flow profiles and behind hydraulic disturbances such as bends or channel profile changes, it allows for a quick initial assessment of the expected

flow conditions and the resulting hydraulic challenges.

Quality Parameters

Four fields show the quality of the measurement (comparable to a signal strength), the quality of the trigger (correspondence of the equality of signal images) as well as the typical and maximum noise of the signal cable.

In the event of measurement problems, they represent important initial diagnostic parameters for the NIVUS service or the specialist companies authorised by NIVUS. They are not relevant for the normal operation of the transmitter and are therefore not explained in detail here.



Using the Quality Parameters determined here

The information on the measurement and trigger quality as well as the signal cable noise is important for the NIVUS commissioning and service personnel.

49 Diagnostics Inputs and Outputs (analogue and digital)

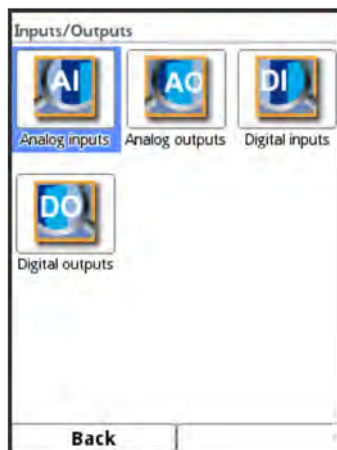

Fig. 49-1 Menu Diagnostics Inputs/Outputs

➡ See also Chapter “39.4 Setting Parameters of Inputs and Outputs (analogue and digital)”.

49.1 Analogue Inputs

In this menu, the current values present at the analogue inputs of the transmitter can be displayed as mA values as well as the measured values (assigned by means of the measuring span parameterised in the transmitter).

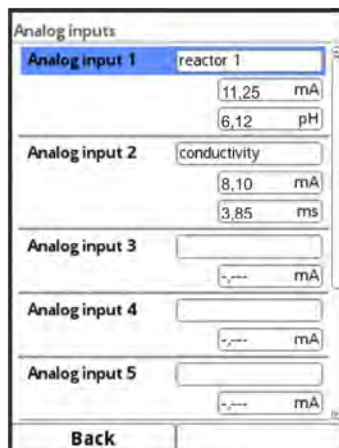

Fig. 49-2 Display of analogue Input Values

With this display, the presence of an external signal and its correct value can be checked without using a measurement device. The immediate conversion into the programmed measurement span enables the plausibility of the measured value to be checked as well as the correct parameterisation of the input span.



Not suitable for checking the function of the A/D converter

A defect in the A/D converter of the transmitter cannot be checked with this function.

49.2 Analogue Outputs

In this menu, the calculated current values to be output at the analogue transformer and the measured values (assigned by means of measurement span) are displayed. A password-protected simulation of the individual analogue values is also possible.

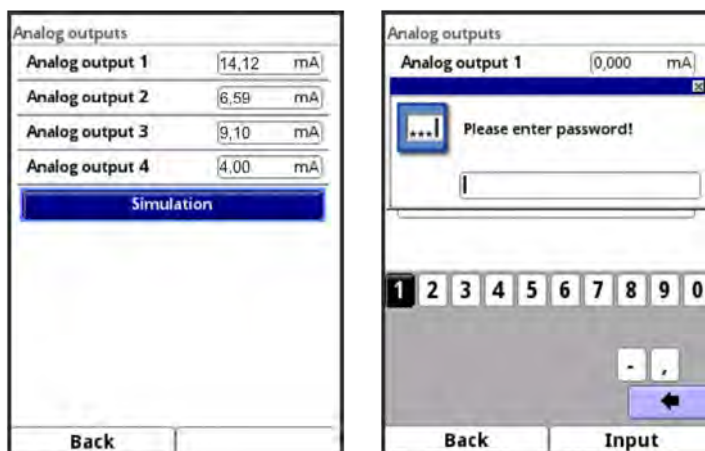

Fig. 49-3 Display of analogue Output Values



The actual flowing currents are not output

*The display only shows the signal that the analogue output converter receives for output.
An external faulty circuit or a defective D/A converter cannot be detected and displayed.*

DANGER**Personal injury or property damage**

The simulation of the analogue outputs shall only be carried out by qualified electricians. These specialists must have precise knowledge of the entire regulation and control process of the system.

Prepare the simulation in detail:

- *Switch the following equipment to manual operation.*
- *Switch off the actuators etc. or limit their function.*

A safety person is absolutely necessary during the performance!

Disregarding may result in personal injury or damage to the system.

Due to the extremely high risk potential and the incalculable consequences of inadequate or incorrect simulation or disregard of the safety instructions, NIVUS hereby decline any responsibility whatsoever for any personal injury or damage to property in any amount!

DANGER**Effect on Plant Sections**

A simulation of the NivuFlow outputs directly accesses all following plant sections without any safety interlock!

Simulations shall only be carried out by qualified personnel.

Be sure to observe the preceding warning!

**Note**

For the previously mentioned safety reasons, access to the simulation is protected by a password.

To protect yourself, only pass on the password to authorised and instructed specialist personnel!

➡ To simulate an analogue output, proceed as follows:

1. Enter the password.
2. Rotate the rotary pushbutton until the desired analogue output is highlighted blue.
3. Press the rotary pushbutton - the analogue output is activated by a tick.
4. Then enter the desired output current as a numerical value.
Make sure that the analogue outputs continue to supply the entered current values until the simulation menu is closed again.
5. Press the left function key to exit the simulation menu.

49.3 Digital Inputs

This menu shows the signals present at the digital inputs.

All available digital inputs (according to the transmitter type) are always displayed, regardless of their activation. The parameterised function of the digital input is shown in brackets after "DI xx".

Inactive digital inputs are identified by the designation "(In. inact.)".

Active digital inputs are identified with a tick.

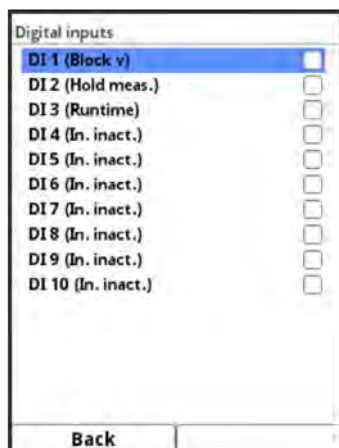

Fig. 49-4 Display of digital inputs

49.4 Digital Outputs

The digital output values available at the transmitter are displayed in this menu. All available digital outputs (according to the transmitter type) are always displayed, regardless of their activation. The parameterised function of the digital output is shown in brackets after "DO xx".

Inactive digital outputs are identified by the designation "(Out inact.)".

Active digital outputs are identified with a tick.

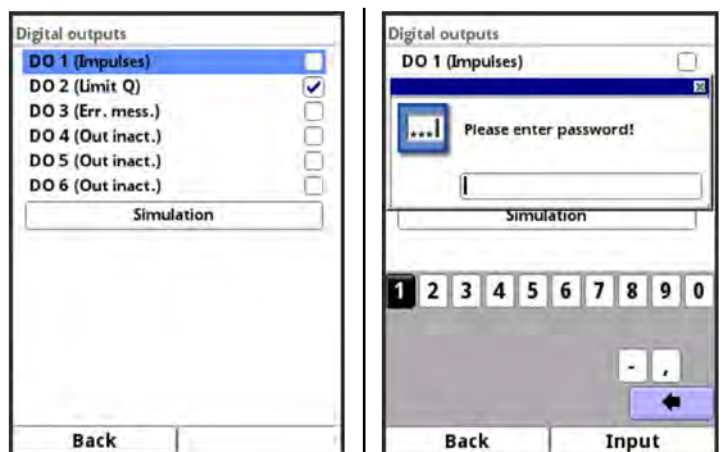

Fig. 49-5 Display of digital outputs

A password-protected simulation of the digital outputs is also available in this menu.

DANGER**Personal injury or property damage**

The simulation of the digital outputs shall only be carried out by qualified electricians. These specialists must have precise knowledge of the entire regulation and control process of the system.

Prepare the simulation in detail.

- Switch the following equipment to manual operation.
- Switch off the actuators etc. or limit their function.

A safety person is absolutely necessary during the performance!

Disregarding may result in personal injury or damage to the system.

Due to the extremely high risk potential and the incalculable consequences of inadequate or incorrect simulation or disregard of the safety instructions, NIVUS hereby decline any responsibility whatsoever for any personal injury or damage to property in any amount!

DANGER**Effect on Plant Sections**

A simulation of the NivuFlow outputs directly accesses all following plant sections without any safety interlock!

Simulations shall only be carried out by qualified personnel.

Be sure to observe the preceding warning!

**Note**

For the previously mentioned safety reasons, access to the simulation is protected by a password.

To protect yourself, only pass on the password to authorised and instructed specialist personnel!

➡ To simulate a digital output, proceed as follows:

1. Enter the password.
2. Rotate the rotary pushbutton until the desired digital output is highlighted blue.
3. Press the rotary pushbutton - the digital output is activated by a tick.
4. Then enter the desired output current as a numerical value.
Make sure that the digital outputs continue to supply the entered current values until the simulation menu is closed again.
5. Press the left function key to exit the simulation menu.

Activating the simulation of each output is done in the same way.

50 Diagnostics Q-Controller

The controller menu is a read-only menu. It is not possible to intervene or to simulate here.



Fig. 50-1 Q-Controller

According to the previously made settings, the currently calculated **Flow** and the **Level** used for this are displayed in controller mode.

The setpoint display corresponds to the **Setpoint** set in the parameter. When using an external, variably adjustable setpoint, the currently used setpoint is displayed.

The **(Control) Deviation** results from the setpoint used and the actual value. This deviation is "frozen" at the beginning of the scanning time and the controller operates with this value during the entire scanning time.

The **Sample time** represents the rhythm in which the controller outputs a possible new control command (cycle time). The display shows the remaining sample time until the next output.

The valve run time is the calculated travel time of the valve (CLOSE/OPEN). According to the parameterised controller function and depending on the control deviation, this time becomes longer or shorter.

The direction of the valve run time is shown on the **Valve CLOSE/OPEN** fields below. The tick is only visible as long as the corresponding relay is activated.

Reaching the respective **End CLOSE/OPEN** switch is indicated by a tick in the boxes below.

In the event of an error, the controller normally goes into a programmable error mode. This transition can be delayed to hide/ignore brief error messages. When an error occurs, the error runtime starts to run up until it has reached the set time for the transition to error mode. This run-up time is visible under **Error Delay**. If the error message disappears during this set time, the error delay display jumps back to "0".

If the torque switch responds "CLOSED", this is indicated by a tick in the **Torque** box.

External manual operation via a programmed digital input is indicated by a tick in the **Manual** box.

51 Diagnostics Flow Profile

This diagnostic menu displays a coloured, three-dimensional flow profile of the measurement place based on the parameterised shape and its dimensions. Here, the individual flow velocity ranges are spatially displayed from the colour blue (standing to slow flow velocity) through green (medium flow velocity) and yellow to red (fast flow velocity).

The calibration of the axes is exclusively automatic and adapts to changing speeds. A colour scale with the minimum and maximum values below the display facilitates the assessment. The display can be switched between >perspective<, >top<, >front< and >side<.

The menu allows a first visual impression of the hydraulics at the measurement place, especially when using several flow velocities in larger channel dimensions. For this purpose, the measured individual velocities and the current filling level are transferred to a 3D model with the dimensions of the measurement place for quick graphical representation using simplified hydraulic models and output graphically.

For exact representation and allocation of the measured individual velocities, the menu >Application< / >Diagnosis< / >v-Sensors< is recommended.

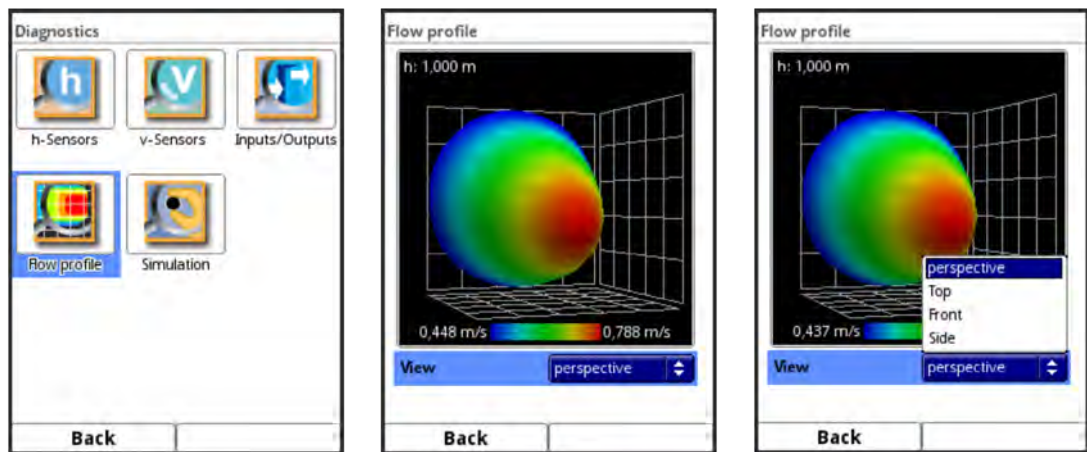

Fig. 51-1 Diagnostics Flow Profile

52 Diagnostics Simulation

In this menu, a theoretical flow can be simulated by manually entering fictitious fill level and flow velocity values in the parameterised application.

The transmitter uses these simulated values - based on the dimensions of the parameterised channel - to calculate the prevailing flow value.

This value is output at the previously defined analogue and digital outputs according to the parameter settings made.

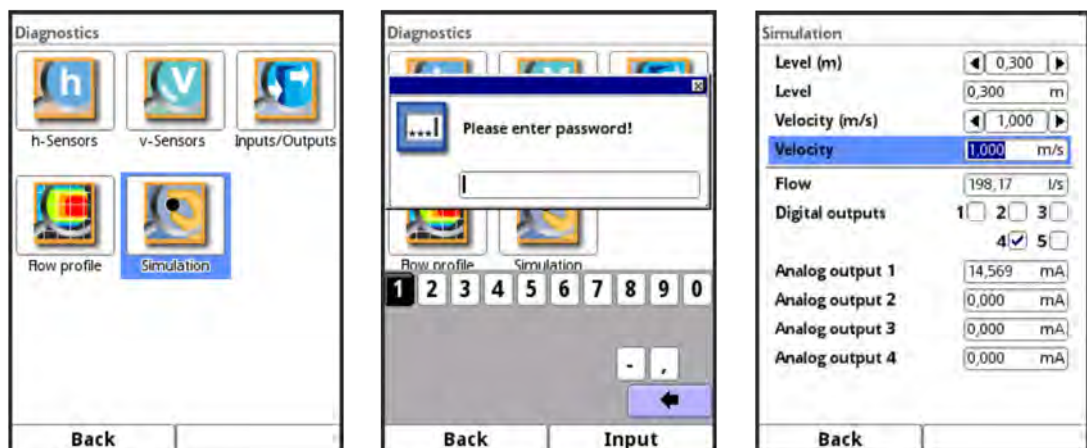

Fig. 52-1 Diagnostics / Simulation

DANGER**Personal injury or property damage**

The simulation shall only be carried out by qualified electricians. These specialists must have precise knowledge of the entire regulation and control process of the system.

Prepare the simulation in detail.

- *Switch the following equipment to manual operation.*
- *Switch off the actuators etc. or limit their function.*

A safety person is absolutely necessary during the performance!

Disregarding may result in personal injury or damage to the system.

Due to the extremely high risk potential and the incalculable consequences of inadequate or incorrect simulation or disregard of the safety instructions, NIVUS hereby decline any responsibility whatsoever for any personal injury or damage to property in any amount!

DANGER**Effect on Plant Sections**

A simulation of the NivuFlow outputs directly accesses all following plant sections without any safety interlock!

Simulations shall only be carried out by qualified personnel.

Be sure to observe the preceding warning!

**Note**

For the previously mentioned safety reasons, access to the simulation is protected by a password.

To protect yourself, only pass on the password to authorised and instructed specialist personnel!

➡ Procedure for the simulation:

1. Enter the password.
2. Turn the rotary pushbutton until the desired value to be simulated (level or velocity) is highlighted in blue.
3. Activate the field by pressing the rotary pushbutton and enter the desired measurement value.
Either at **Level [m]** or **Velocity [m/s]** by rotating the rotary pushbutton in 1/1000 steps or at **Level** or **Velocity** with direct entry of the value.
4. Confirm entry with the right function key.
The **Flow** field automatically displays the flow rate value calculated by the two simulated level/speed values.
Any parameterised digital/analogue outputs behave as if they were actually parameterised and output these values in real terms.
These output signals and values are shown on the display.
5. Press the left function key to exit the simulation menu.

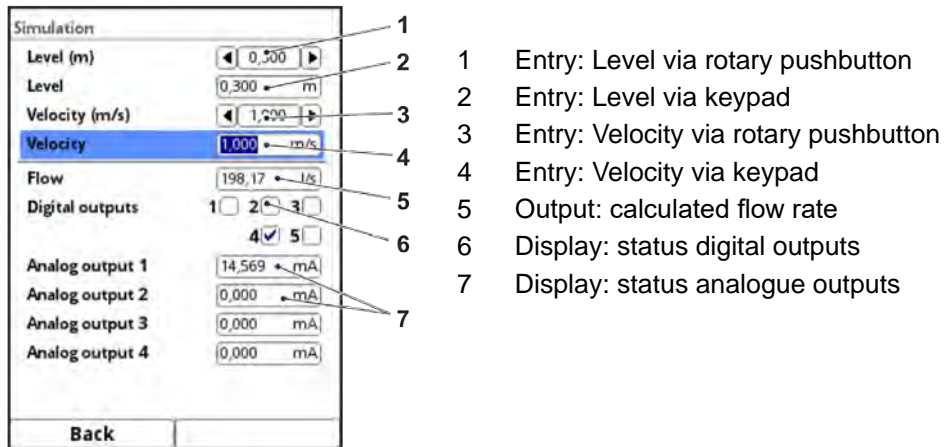

Fig. 52-2 Display of calculated values and output states

Maintenance and Cleaning

WARNING***Disconnect instrument from mains***

Disconnect the instrument from mains power and safeguard the higher system against restart before you begin maintenance works.

Disregarding may lead to electric shocks.

WARNING***Contamination by hazardous germs***

Due to being frequently used in wastewater applications, some portions of the measurement system may be loaded with hazardous germs. This is why precautionary measures shall be taken while being in contact with the system, cables and sensors.

Wear protective clothing.

53 Maintenance

53.1 Maintenance interval

The NivuFlow transmitters are conceived to be virtually free of calibration, maintenance and wear.

NIVUS recommends to have the entire measurement system inspected by the NIVUS customer service once per year.

Depending on the area of use the maintenance intervals however may vary.

Extent and intervals of maintenance depend on the following conditions:

- Measurement principle for Level Sensors
- Material wear
- Fluid and channel hydraulics
- General regulations for the operators of the measurement facility
- Ambient conditions

NIVUS recommends to have the measurement system completely be inspected by the manufacturer **after latest ten years**.

Generally the verification of instruments and sensors is a basic measure in order to improve operational reliability and to increase the lifetime.

53.2 Customer Service Information

For the recommended annual inspection of the entire measurement system and/or the extensive inspection after latest ten years contact our customer service:

NIVUS GmbH - Customer Service

Phone +49 7262 9191-922

customercenter@nivus.com

54 Cleaning

54.1 Transmitter

WARNING**Disconnect instrument from mains**

Disconnect the instrument from mains power before cleaning.

Disregarding may lead to electric shocks.

**Important Note**

- Do not remove the **blue plastic rails** to clean the enclosure.
- Do not use a damp cloth or similar to wipe over the **terminal clamp blocks**.

Clean the transmitter enclosure if required using a dry, lint-free cloth.

For stubborn dirt the enclosure can be cleaned using a damp cloth. Do not use sharp cleansing agents or solvents. Light household cleaners or soapy water can be used.

54.2 Sensors

The hints on how to maintain and clean the sensors shall be necessarily observed. These hints can be found in the "Technical Instruction" and/or the "Instruction Manual".

This (these) document(s) is (are) part of the standard sensor delivery.

55 Dismantling/Disposal

Improper disposal may be harmful to the environment.

- Always dispose equipment components and packaging materials according to applicable local regulations on environmental standards for electronic products:

1. Disconnect the unit from mains power.
2. Use appropriate tools to remove the connected cables from the faceplate of the instrument.
3. Remove the transmitter from the DIN rail.
4. Remove the backup battery (see procedure described below) and make sure that the backup battery will be disposed of separately.

**EC WEEE-Directive logo**

This symbol indicates that the Directive 2012/19/EU on waste electrical and electronic equipment requirements shall be observed on the disposal of the equipment. NIVUS GmbH supports and promotes the recycling and environmentally friendly, separate collection/disposal of waste electrical and electronic equipment in order to protect the environment and human health. Observe the local disposal regulations and laws.

NIVUS GmbH is registered with the EAR, therefore public collection and return points in Germany can be used for disposal.

The unit contains a buffer battery (Lithium coin cell), which must be disposed of separately.

➡ Procedure for removing the buffer battery on the removed transmitter:

1. If present, remove the four blue plastic strips (Pos. 1). These are plugged in and glued to the basic unit.

Info:

If the transmitter was installed in a field housing, these plastic strips are not present.

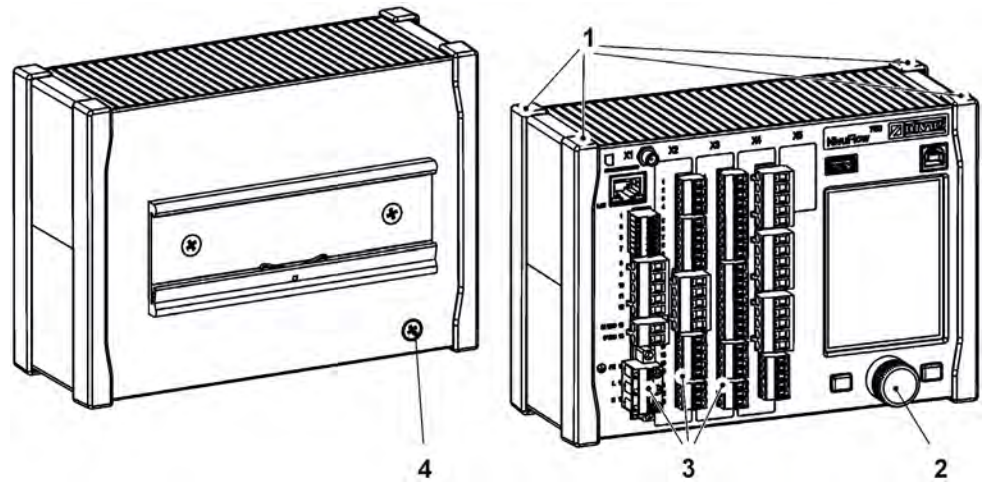

2. Remove the cover cap (Pos. 2) on the rotary pushbutton with a screwdriver or similar.
3. Loosen the fastening inside the rotary push-button with a screwdriver or similar.
4. Unscrew the countersunk screw M4x8 (Pos. 4) (for earthing/fastening) incl. serrated lock washer on the back of the housing.
5. Pull off the rotary pushbutton and existing connector strips (Pos. 3) from the front of the enclosure.
6. Unscrew 4x M3 Torx self-tapping screws on the front of the enclosure (previously covered by the plastic strips) and remove the front panel together with the circuit boards.



7. Remove the buffer battery (Pos. 5) mounted on the upper board.

56 Installation of spare parts and parts subject to wear and tear

We herewith particularly emphasise that replacement parts or accessories not supplied by NIVUS moreover are not certified and approved by NIVUS too. Installation and/or the use of such products hence may negatively influence predetermined constructional characteristics of the measurement system or even lead to instrument failures.

NIVUS cannot be held responsible for any damage resulting due to the use of non-original parts and non-original accessories.



A selection of NIVUS GmbH accessories can be found in chapter "57 Accessories".

57 Accessories

Article Number	Description
<i>iXT0 xxx</i>	Intelligent Ex-Separator Module
<i>MPX0 421</i>	Multiplexer for RS485 sensors in non-Ex areas
<i>ZUB0 USB 16</i>	USB stick 16 GB for readout of parameter settings and measurement values using the NivuFlow USB interface
<i>SW0 NS PRO</i>	Evaluation software, NivuSoft Professional with matched functions: documentation of measurement sites, output as graphs and tables, creation of statistics/reports etc.
<i>BSL0 xx</i>	Overvoltage protection for power supply, sensors and data lines of the transmitter
<i>ZUB0 NFWx</i>	Field enclosure in different versions to protect the NivuFlow in outdoor areas
<i>NFX0 LIZENZ HART</i>	Device licence for activation: HART protocol on analogue output (for later activation)

Table 1 Accessories for transmitter NivuFlow 750/700



Further information on spare parts and accessories can be obtained from your local representative/regional office or directly from NIVUS GmbH.

Index

Symbole

>Browse< Function	138
1-Parameter-Programming	110

A

Accessories	196
Accident level	15
Advance Main Display	
NF 750 M9	172
Air Temperature	
Analogue Output	121
Analogue Input	
Diagnostics	185
Analogue Output	
Diagnostics	185
Approvals	202
Article number	27

B

Backlight	171
Backup battery	194
Basic menus	75
Baudrate	
Connections	178
Block v-Measurement	
Digital Input	123
Branch offices	2

C

Calming section	45
CE label	24
Change Password	86
Chemicals	36
Clock Control	
Data Memory	146
Communication	
HART	169
Modbus	169
TCP/IP	162
Web Server	163
Compress	143
Connections	12, 19
Control elements	12, 13, 72
Control Threshold	
Q-Controller	131
Copyright	3
Customer Service	193

D

Damage in transit	21
Data Depth	
Expert	143
Extended	142
Standard	142
USB-Stick	142
Data memory	26
Data Transmission	
E-Mail	166
FTP	165
MQTT	164
Date/Time Selection	137
Delivery	21
Device identification	24
Device setup	22
Device Types	27
Digital Input	
Diagnostics	187
Digital Output	
Diagnostics	187
Display	
Overview	72
Disposal	194
of materials	19
of products	19

E

EC WEEE-Directive	194
Environmental standards	194
Error Delay	
Q-Controller	132
Error Message	
Digital Output	128
Error Runtime	
Q-Controller	132
ESD	
Electrostatic discharge	34
Risks	34
Events Interval	
Powerdown / Cycle Operation	148
External Measurement Value	
Analogue Output	121

F

File Format	
USB-Stick	142
File Naming	145
Flow	
Analogue Output	120

Flow distribution
 3-dimensional..... 31

Flow profile
 Diagnostics..... 190

Flow profiles
 asymmetric..... 31

Flow Velocity
 Analogue Output 121

Flush with Wall 109

G

Gases..... 36

Germ contamination..... 16

H

HART
 Analogue Output 122
 Communication 169

Hazardous germs..... 193

h-crit
 Low Levels 117

h-crit automatic
 Low Levels 116

Heavy shocks..... 21

h-manual
 Low Levels 116

Hotline 71

Humidity 21, 26

I

Impulse Counter
 Digital Input 123

Installation Instructions..... 34

Installation place 34

Installation regulations 38

Instruction manual 21

Instructions..... 71

K

Keep the manual 19

L

Language 153
 Operation 153

Letter block..... 74

Level
 Analogue Output 120

Level Sensor
 Analogue Output 121

Level Sensors
 Selection 101

Liability disclaimer 17

Limit Contact Air Temperature
 Digital Output 127

Limit Contact External Measurement
 Value
 Digital Output 128

Limit Contact Flow
 Digital Output 126

Limit Contact Level
 Digital Output 127

Limit Contact Sludge
 Digital Output 128

Limit Contact Velocity
 Digital Output 127

Limit Contact Water Temperature
 Digital Output 127

Load Parameters..... 144

Lockscreen
 Screen/Display 171

Logging
 Digital Input 124

Low-voltage network 44

M

Main Menu 86

Maximum Q
 Q-Controller..... 131

Max. On Time
 Q-Controller..... 132

Measurement windows 30

Measures to prevent accidental
 contacts..... 45

Min. On Time
 Q-Controller..... 132

Modbus
 Communication 169

Modbus Slave
 Analogue Output 121
 Digital Output 129

N

Nameplates 25

Names 3

Negative offset value..... 32

Non-original accessories..... 196

Non-original parts..... 196

Numeric keypad 75

O

Operating conditions	26
Operation Mode	
Powerdown / Clock Control.....	147
Output Fields.....	172
Overvoltage category	26
Overvoltage protection elements	46

P

Parts subject to wear and tear	196
Period.....	137
P-Factor	
Q-Controller.....	131
Piezoresistive	33
Pollution degree	26
Power consumption	
max.	25
typ.	25
Powerdown	
Data Memory.....	146
Power supply.....	25
Precautions	16
Product construction	22
Product overview.....	22
Property rights.....	3
Protection	26
Protection class.....	26
Protective conductor	16
Provide the manual	19

Q

Q-Controller	
Diagnostics.....	189
Q-Factor	
Q-Controller.....	133
Q-Quick Close	
Q-Controller.....	133
Q suppressed	
Low-Flow.....	99
Qualified personnel	20, 71
Quick Close Runtime	
Q-Controller.....	133

R

Radioactive radiation.....	36
RCD	38
Reflect.....	29
Reflection pattern	29

Relative pressure principle.....	33
Replacement part ordering.....	24
Reset	
Measurement	159
Parameter	159
Residual-current-operated protective device.....	38
Restart	
Measurement	159
System	159
Return	21
Revision History	4
Revision of parameters	75
Runtime	
Digital Input.....	123
Runtime from Pos. Close	
Q-Controller.....	132

S

Safety Instructions.....	15
Sample Time	
Q-Controller.....	131
Save Parameters	144
Sensors	27
Sensor Velocity	
Analogue Output	121
Setpoint Modbus	
Q-Controller.....	131
Setpoint w	
Q-Controller.....	131
Signal words.....	15
Simulation	
Diagnostics.....	190
Slider OPEN	
Digital Output	129
Slider Runtime	
Q-Controller.....	132
Sludge Level	
Analogue Output	121
SNTP	
Time Server.....	156
Spare parts.....	196
Specifications	25
Storage cycle	26
Storage Cycle	
Basic Functions.....	146
Powerdown / Clock Control.....	148
Sum Impulses	
Digital Output	125
Sunlight	36
System Time	156

T

TCP/IP	
Communication	162
Temperature	21
Ambient, max.	26
Operating	26
Storage.....	26
Theoretical Flow	
Simulation	190
Time Zone	156
Totalising	140
Translation.....	3
Transmission Period	
USB-Stick.....	141
Transport	21
Trend Graph	77

U

Ultrasonic Cross Correlation	29
Ultrasound reflection principle	29
Units System	154, 155
Used symbols.....	15
Use in accordance with the requirements	18
User's Responsibilities	19

V

v-crit	
Low Levels	117
v-Determination Automatic	
Low Levels	116
Vibrations	21
v-manual	
Low Levels	116
v suppressed	
Low-Flow.....	99

W

Warning notices on the product.....	16
Warranty.....	17
Water Temperature	
Analogue Output	121
Water-ultrasonic combi sensor.....	32
Web Server	
Communication	163
Wire cross section	39

Credits and Licences

58 List of references of the licences and codes used

The transmitter type NivuFlow uses code of the following Open Source Projects:

- Freetype (<http://www.freetype.org>)
- Libharu (<http://libharu.org>)
- Libjpeg (<http://www.ijg.org>)
- Libpng (<http://www.libpng.org>)
- Zlib (<http://www.zlib.net>)
- Mini-XML (<http://www.msweet.org>)
- Nano-X/nxlib (<http://www.microwindows.org>)
- FLTK (<http://www.ftk.org>)
- Appendix1: LGPL
- Appendix2: MPL

**Note**

If you have any questions concerning licences refer to opensource@nivus.com

Approvals and Certificates

DE / EN / FR

EU Konformitätserklärung

EU Declaration of Conformity

Déclaration de conformité UE

Für das folgend bezeichnete Erzeugnis:

For the following product:

Le produit désigné ci-dessous:

Bezeichnung:	Durchflussmessumformer stationär mit internem 2G/3G/4G Modem zur Datenfernübertragung NivuFlow 7xx/Energy Saver
<i>Description:</i>	<i>Permanent flow measurement transmitter with internal modem for remote data transmission</i>
<i>Désignation:</i>	<i>Transmetteur de débit stationnaire avec modem intégré pour transmission de données</i>
Typ / Type:	NF7-... / NR7-...

erklären wir in alleiniger Verantwortung, dass die auf dem Unionsmarkt ab dem Zeitpunkt der Unterzeichnung bereitgestellten Geräte die folgenden einschlägigen Harmonisierungsvorschriften der Union erfüllen:

we declare under our sole responsibility that the equipment made available on the Union market as of the date of signature of this document meets the standards of the following applicable Union harmonisation legislation:

nous déclarons, sous notre seule responsabilité, à la date de la présente signature, la conformité du produit pour le marché de l'Union, aux directives d'harmonisation de la législation au sein de l'Union:

- 2014/53/EU
- 2011/65/EU

Bei der Bewertung wurden folgende einschlägige harmonisierte Normen zugrunde gelegt bzw. wird die Konformität erklärt in Bezug auf die nachfolgend genannten anderen technischen Spezifikationen:

The evaluation assessed the following applicable harmonised standards or the conformity is declared in relation to other technical specifications listed below:

L'évaluation est effectuée à partir des normes harmonisées applicable ou la conformité est déclarée en relation aux autres spécifications techniques désignées ci-dessous:

- EN 61010-1:2010 + A1:2019 + A1:2019/AC:2019
- EN 61326-1:2013
- Draft ETSI EN 301 489-52 V1.2.1
- EN 301 908-1 V15.2.0 (UMTS/3G, LTE/4G)
- EN 301 908-13 V13.2.1 (LTE/4G)
- EN 62311:2008
- EN 301 489-1 V2.2.3
- EN 301 511 V12.5.1 (GSM/2G)
- EN 301 908-2 V13.1.1 (UMTS/3G)

Diese Erklärung wird verantwortlich für den Hersteller:

This declaration is submitted on behalf of the manufacturer:

Le fabricant assume la responsabilité de cette déclaration:

NIVUS GmbH
Im Taele 2
75031 Eppingen
Germany

abgegeben durch / *represented by* / *faite par:*

Ingrid Steppe (Geschäftsführerin / *Managing Director* / *Directeur général*)

Eppingen, den 21.10.2022

Gez. *Ingrid Steppe*



NIVUS GmbH
Im Taele 2
75031 Eppingen

Telefon: +49 07262 9191-0
Telefax: +49 07262 9191-999
E-Mail: info@nivus.com
Internet: www.nivus.de

UK Declaration of Conformity

NIVUS GmbH
Im Tale 2
75031 Eppingen

Telefon: +49 07262 9191-0
Telefax: +49 07262 9191-999
E-Mail: info@nivus.com
Internet: www.nivus.de

For the following product:

Description:	Permanent flow measurement transmitter with internal modem 2G/3G/4G for remote data transmission NivuFlow 7xx / Energy Saver
Type:	NF7-... / NR7-...

we declare under our sole responsibility that the equipment made available on the UK market as of the date of signature of this document meets the standards of the following applicable UK harmonisation legislation:

- SI 2017 / 1206 The Radio Equipment Regulations 2017
- SI 2012 / 3032 The Restriction of the Use of Certain Hazardous Substances in Electrical and Electronic Equipment Regulations 2012

The evaluation assessed the following applicable harmonised standards or the conformity is declared in relation to other technical specifications listed below:

- BS EN 61010-1:2010 + A1:2019 + A1:2019/AC:2019
- BS EN 61326-1:2013
- Draft ETSI EN 301 489-52 V1.2.1
- BS EN 301 908-1 V15.2.0 (UMTS/3G, LTE/4G)
- BS EN 301 908-13 V13.2.1 (LTE/4G)
- BS EN 62311:2008
- BS EN 301 489-1 V2.2.3
- BS EN 301 511 V12.5.1 (GSM/2G)
- BS EN 301 908-2 V13.1.1 (UMTS/3G)

This declaration is submitted on behalf of the manufacturer:

NIVUS GmbH
Im Tale 2
75031 Eppingen
Germany

represented by:

Ingrid Steppe (Managing Director)

Eppingen, 21/10/2022

Signed by *Ingrid Steppe*

EU Konformitätserklärung

EU Declaration of Conformity

Déclaration de conformité UE

NIVUS GmbH
Im Täle 2
75031 Eppingen

Telefon: +49 07262 9191-0
Telefax: +49 07262 9191-999
E-Mail: info@nivus.com
Internet: www.nivus.de

Für das folgend bezeichnete Erzeugnis:

For the following product:

Le produit désigné ci-dessous:

Bezeichnung:	Durchflussmessumformer stationär NivuFlow 7xx / Energy Saver
<i>Description:</i>	<i>permanent flow measurement transmitter</i>
<i>Désignation:</i>	<i>convertisseur de mesure de débit fixe</i>
Typ / Type:	NF7-... / NR7-...

erklären wir in alleiniger Verantwortung, dass die auf dem Unionsmarkt ab dem Zeitpunkt der Unterzeichnung bereitgestellten Geräte die folgenden einschlägigen Harmonisierungsvorschriften der Union erfüllen:

we declare under our sole responsibility that the equipment made available on the Union market as of the date of signature of this document meets the standards of the following applicable Union harmonisation legislation:

nous déclarons, sous notre seule responsabilité, à la date de la présente signature, la conformité du produit pour le marché de l'Union, aux directives d'harmonisation de la législation au sein de l'Union:

- 2014/30/EU
- 2014/35/EU
- 2011/65/EU

Bei der Bewertung wurden folgende einschlägige harmonisierte Normen zugrunde gelegt bzw. wird die Konformität erklärt in Bezug die nachfolgend genannten anderen technischen Spezifikationen:

The evaluation assessed the following applicable harmonised standards or the conformity is declared in relation to other technical specifications listed below:

L'évaluation est effectuée à partir des normes harmonisées applicable ou la conformité est déclarée en relation aux autres spécifications techniques désignées ci-dessous:

- EN 61326-1:2013
- EN 61010-1:2010 + A1:2019 + A1:2019/AC:2019

Diese Erklärung wird verantwortlich für den Hersteller:

This declaration is submitted on behalf of the manufacturer:

Le fabricant assume la responsabilité de cette déclaration:

NIVUS GmbH
Im Täle 2
75031 Eppingen
Allemagne

abgegeben durch / *represented by / faite par:*

Ingrid Steppe (Geschäftsführerin / *Managing Director / Directeur général*)

Eppingen, den 21.10.2022

Gez. *Ingrid Steppe*

UK Declaration of Conformity

NIVUS GmbH
Im Tale 2
75031 Eppingen

Telefon: +49 07262 9191-0
Telefax: +49 07262 9191-999
E-Mail: info@nivus.com
Internet: www.nivus.de

For the following product:

Description:	Permanent flow measurement transmitter NivuFlow 7xx / Energy Saver
Type:	NF7-... / NR7-...

we declare under our sole responsibility that the equipment made available on the UK market as of the date of signature of this document meets the standards of the following applicable UK harmonisation legislation:

- SI 2016 / 1091 The Electromagnetic Compatibility Regulations 2016
- SI 2016 / 1101 The Electrical Equipment (Safety) Regulations 2016
- SI 2012 / 3032 The Restriction of the Use of Certain Hazardous Substances in Electrical and Electronic Equipment Regulations 2012

The evaluation assessed the following applicable harmonised standards or the conformity is declared in relation to other technical specifications listed below:

- BS EN 61326-1:2013
- BS EN 61010-1:2010 + A1:2019 + A1:2019/AC:2019

This declaration is submitted on behalf of the manufacturer:

NIVUS GmbH
Im Tale 2
75031 Eppingen
Germany

represented by:

Ingrid Steppe (Managing Director)

Eppingen, 21/10/2022

Signed by *Ingrid Steppe*