



Dial device

Help



Creating connection



NivuChannel

Flow Measurement
for part filled and full
Pipes, Channels and
Surface Water Bodies

@ Internet access

NIVUS - innovation and high accuracy

The NivuChannel is a permanent measurement system for continuous flow measurement, flow control and storage of recorded readings. It is designed for use in a range of clean to polluted media of various consistencies which are to be measured in part filled and full pipes, channels and flumes with various shapes and dimensions.

NivuChannel utilises the ultrasonic transit time principle. This ensures a versatile range of use achieving high-accuracy results.

Flow measurement in a channel
The best conditions possible
for NivuChannel

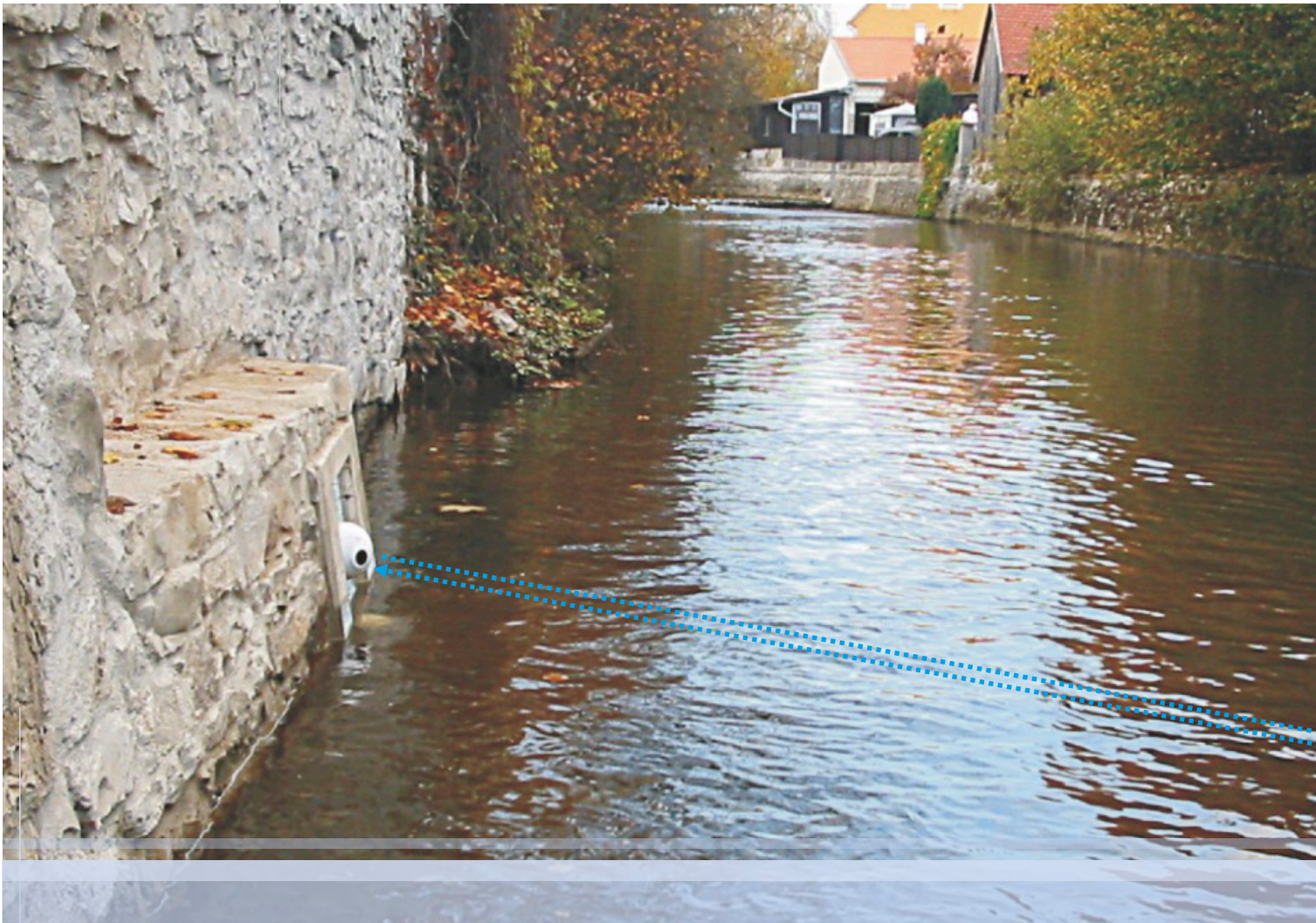

Overview on transmitter details

- ultrasonic transit time measurement with 1 to 8 measurement paths
- highest accuracy
- measurement in clear to heavily polluted water
- measurement according to IEC 60041 (ASME PTC 18)
- measurement in pipes, open channels and surface water bodies
- easy, multilingual setting of parameters in dialog mode
- large, back-lit graphic display
- storage of all measurement data on compact flash card
- worldwide communication
- online connection/data transmission and remote maintenance via Internet
- distance between sensors and transmitter up to 300 m by using adapter box



Typical applications for NivuChannel

- permanent measurement of surface water bodies such as rivers, channels etc.
- irrigation systems
- inlets and outlets conducting cooling water or circulation systems
- wastewater treatment plants: inlet, discharge and much more
- measurements on storm water basin, storm water retention basin, storm water sedimentation tank
- direct discharger control, investigation of extraneous water or leakage
- industrial wastewater networks
- industrial flow measurements
- and much more

How the NivuChannel measures

Ultrasonic flow measurement is an indirect measurement method. The flow rate is calculated from a velocity measurement and a wetted area related to the water level. This is where the general equation of continuity comes into effect:

$$Q = A \cdot v_A$$

A = cross-sectional area
 v_A = average flow velocity in cross-sectional area

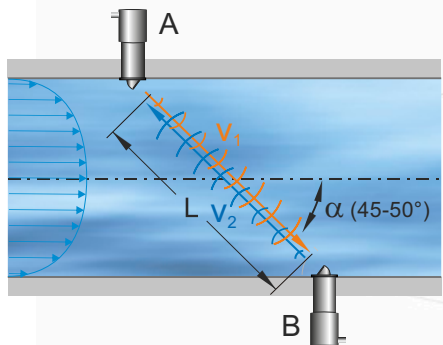

The measurement system calculates the average cross-sectional area velocity v_A from the path velocity v_m and allows to indicate it directly on the display.

$$v_m = \frac{c^2}{2 \cdot L \cdot \cos \alpha} \cdot \left(\frac{1}{t_1} - \frac{1}{t_2} \right)$$

c = velocity of sound
 t₁ = time from A to B, t₂ = time from B to A

The NivuChannel measurement principle is based on detecting the transit time of ultrasonic signals between two sensors (A and B). The transit time in flow direction t₁ is shorter than it is against the flow direction t₂. The difference between both transit times is proportional to the average flow velocity along the measurement path v_m.

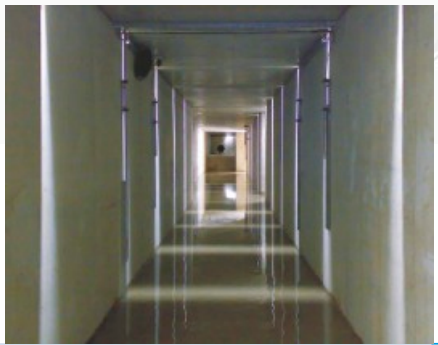

Measurements in part filled and full pipes

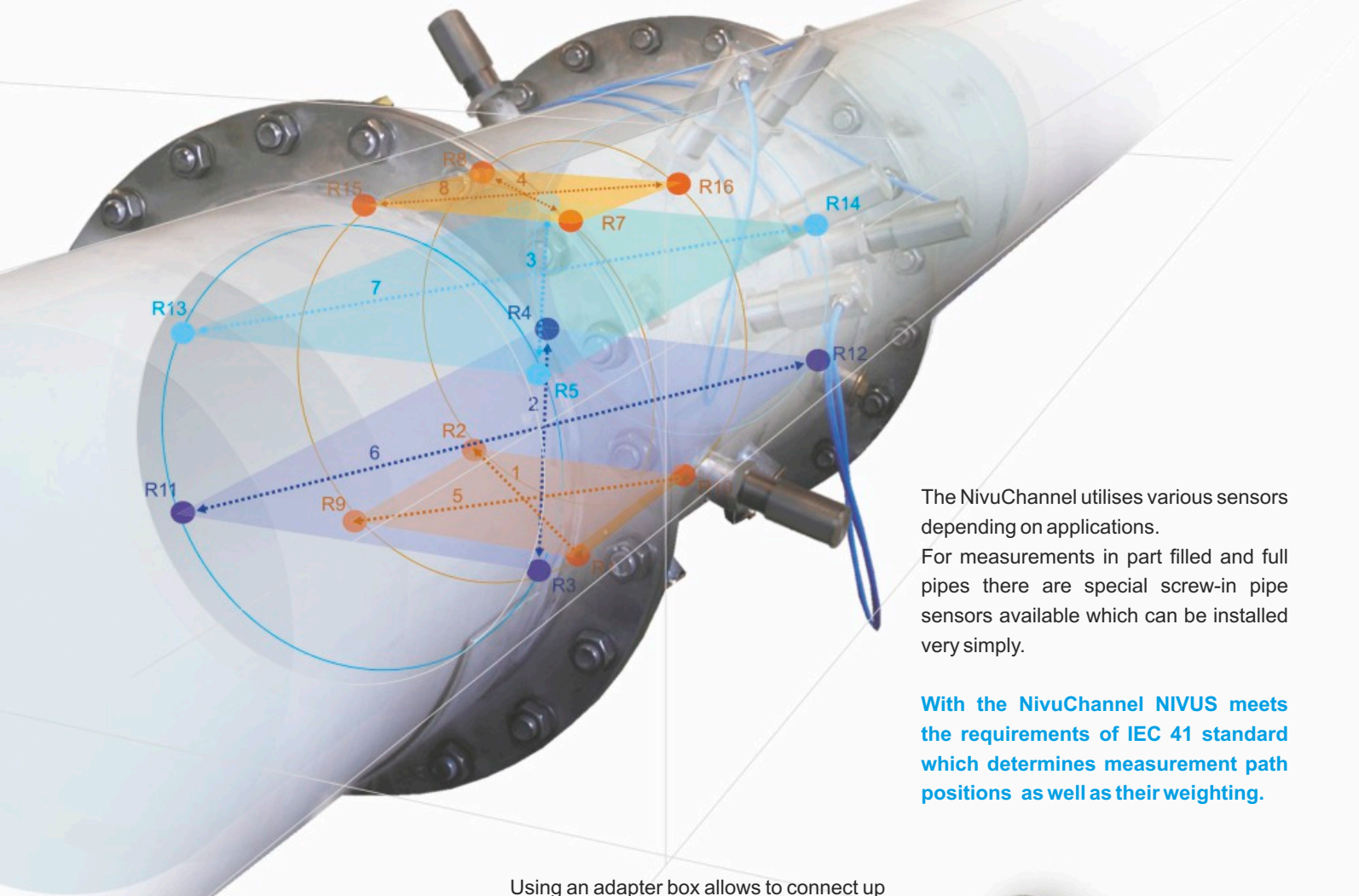

The NivuChannel utilises various sensors depending on applications. For measurements in part filled and full pipes there are special screw-in pipe sensors available which can be installed very simply.

With the NivuChannel NIVUS meets the requirements of IEC 41 standard which determines measurement path positions as well as their weighting.

Using an adapter box allows to connect up to 16 Sensors.

This adapter box in combination with a measurement using up to 8 paths enable to achieve highest accuracies even in very difficult applications.

In case of a fully developed flow velocity profile in pipes in most cases it is sufficient to use a single path measurement (1E1P).

Normally there are distorted flow profiles however which have negative effects on the measurement accuracy. Such influences can be compensated by using the NivuChannel in combination with up to 8 measurement paths.



Pipe sensor available as plug-in or screw-in sensor



Assessing the measurement place



Installed rod sensor with accessories



Calibrating and testing the NivuChannel



Measurement in open channels

Measuring in open channels and rivers is very demanding regarding the measurement technology used.

From indefinable cross-sectional profiles to movable river beds there are conditions making it very difficult to use standard measurement technologies.

The NivuChannel has been developed particularly for use under such conditions and, in combination with other measurement units, is capable of meeting the requirements of very difficult applications..

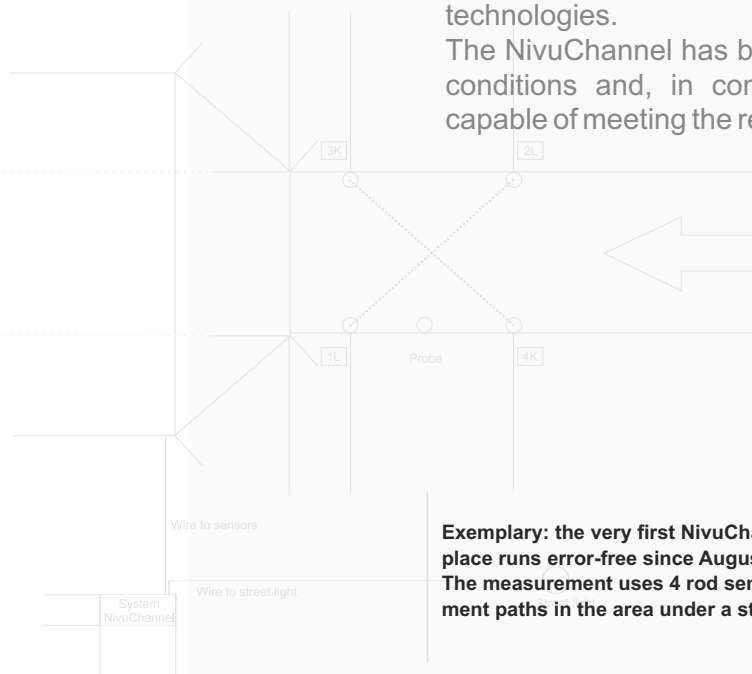

Exemplary: the very first NivuChannel measurement place runs error-free since August 2006. The measurement uses 4 rod sensors via 2 measurement paths in the area under a street bridge.



Rod sensor



View of measurement place



For use in open channels there are 8 measurement paths available as well. Right as in full pipes the number of used measurement paths will enormously increase the measurement accuracy.

A special focus regarding the Nivu-Channel has been put on easy programming of extraordinary profiles.

Sensors

Particularly for measurements in channels and rivers NIVUS have developed high accurate sensors. Rod sensors available in various lengths and hemisphere sensors provide the best possible options for almost any application. Special mounting accessories facilitate installation on site.

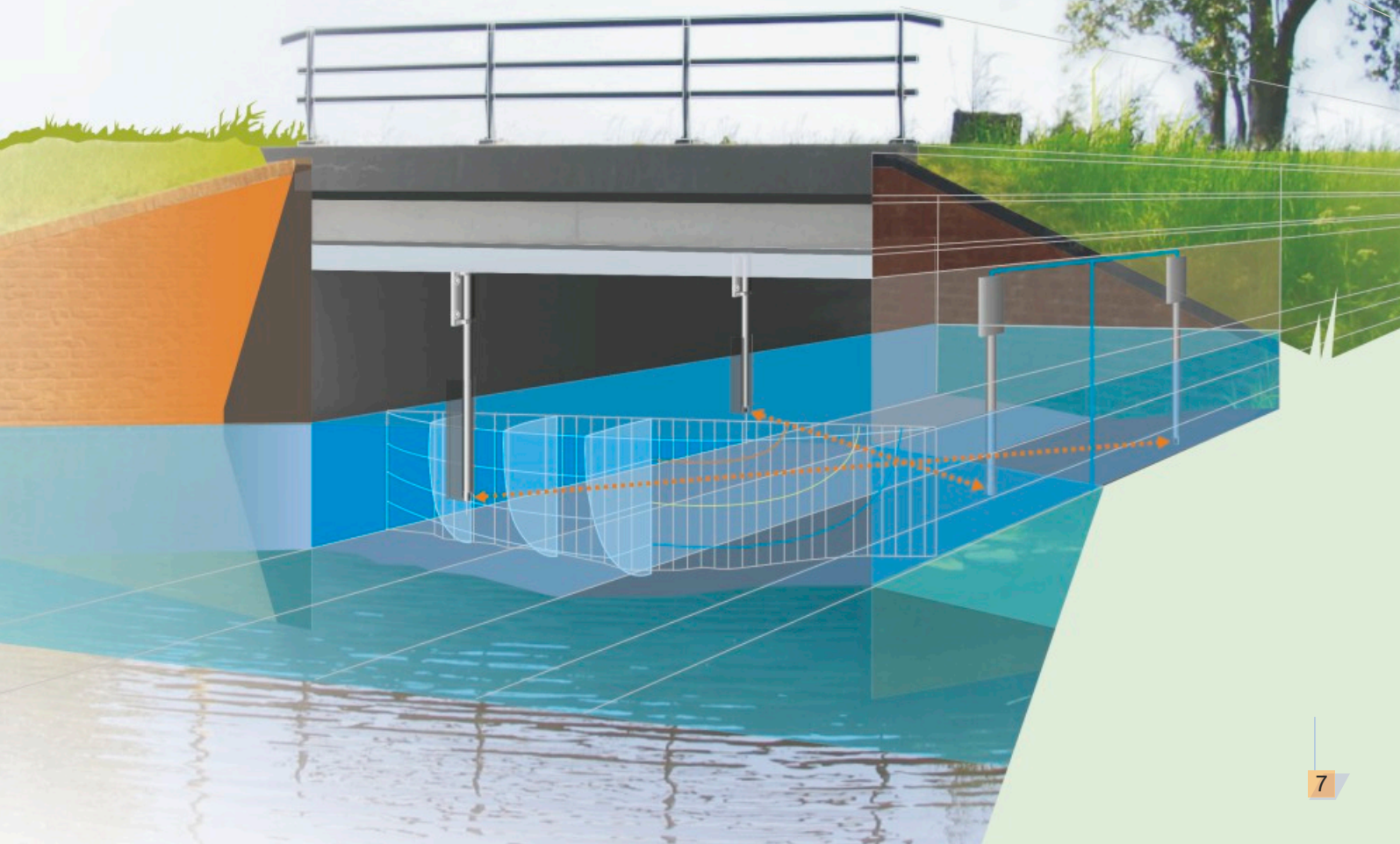

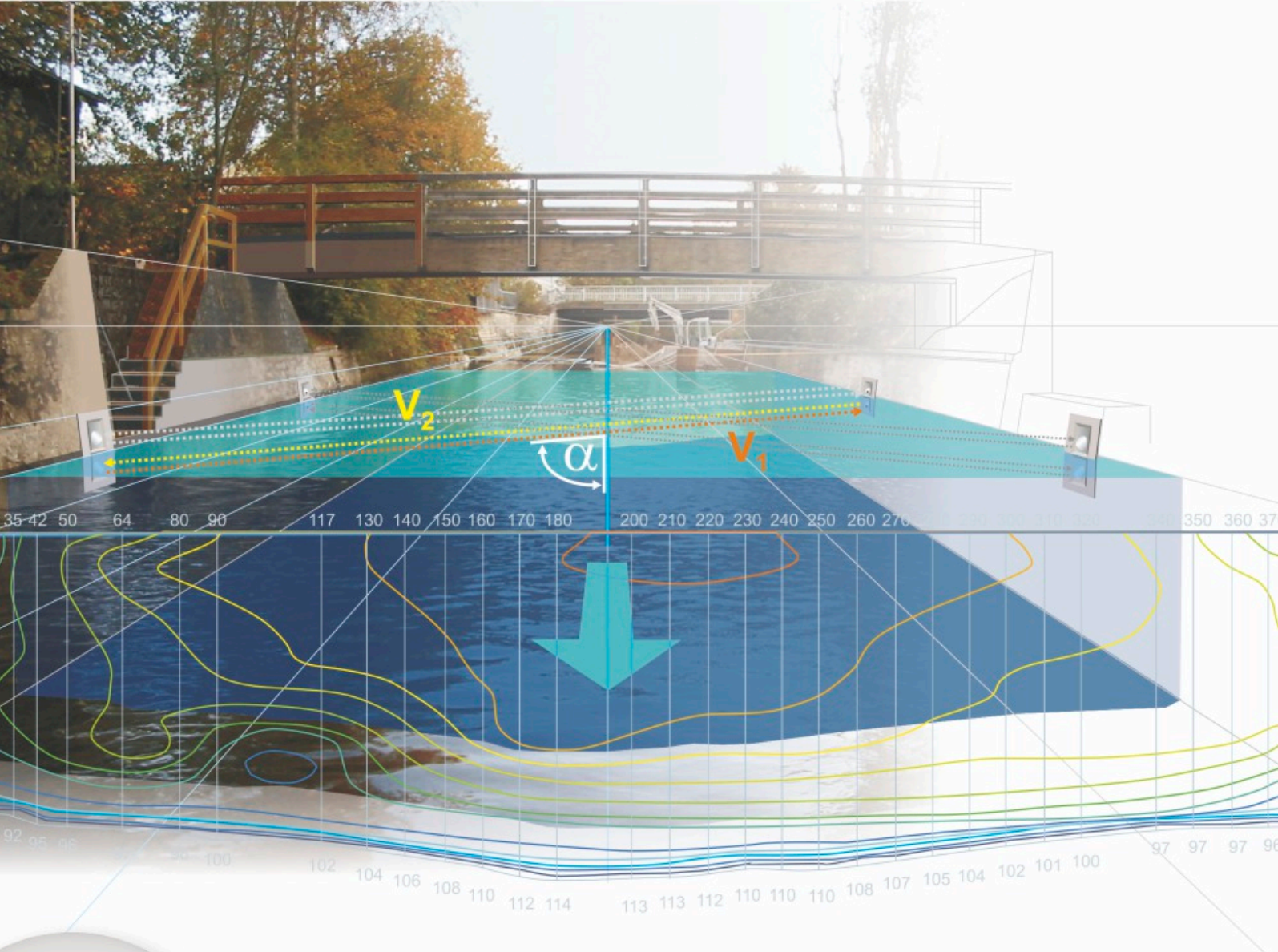

Hemisphere sensor

NIVUS - setting exemplary solutions

Numerous reliable measurement places using the NivuChannel indicate its level of sophistication in daily use.

This is accomplished by using both technology as well as planning which is focused on meeting the requirements of the respective applications. Benefit from decades of experience and the know-how our engineers, technicians and expert staff have gained.

If desired, we will implement the complete planning and evaluating stages for you.



Flow measurement using the NivuChannel in a slowly flowing water body.

Selection and planning of the measurement place as well as channel profile set-up. The channel has a rectangular profile with a natural river bed.

Rising and falling water levels had to be taken into account.



There are 8 hemisphere sensors in use which measure crosswise utilising 4 measurement paths in 2 measurement levels.

The upper measurement levels will switch on in case of rising water level. The sensors have been screwed onto a stainless steel plate (available as accessory), the concrete baseplate has been set up before.

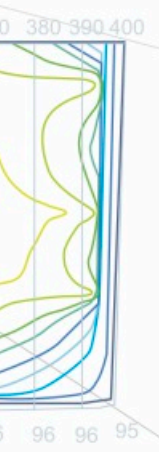

Do you need individual solutions for your measurement problems or you are interested in other application examples and references?

[Talk to us.](#)



Channel profiles can be set up easily and directly on the unit.

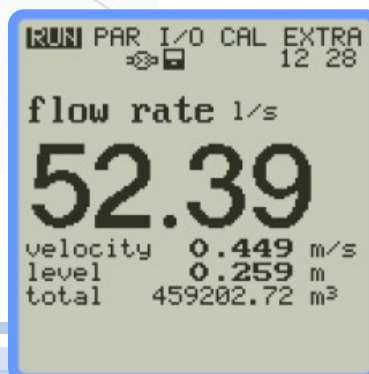

Direct reading of the flow rate.

Always perfectly up-to-date



NivuChannel power supply using the street lighting



Clearly installed in a switching cabinet



No installation problems through perfectly fitting accessories for the rod sensors

Operation / Programming

It is very easy to put the system into operation and to recall data since the large graphic display is clearly laid out for the various applications.

Settings are clearly indicated on the graphic display. This virtually eliminates faulty programming.

Data storage

Any of the recorded readings as well as up to 4 additional external analog signals can be saved in free intervals if the NivuChannel has been equipped with a compact flash card.

Data can be read and evaluated easily.

Evaluation

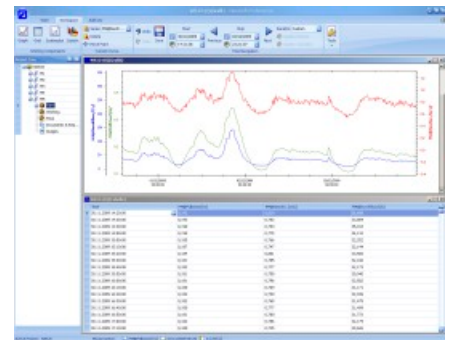

The NivuChannel comes with the free evaluation software **NivuSoft** which, besides using other common spreadsheet applications, allows to quick and clearly indicate measurement data as graphs or tables under Windows XP / Windows 7.

This ensures to read out saved raw data very comfortably. Additional processing functions such as sequential data export, averaging, output of min. and max. values, measurement place management and more complete the program.



The clear program structure allows to easily set parameters.

Diagnostics

The status of analog and digital inputs can be indicated and recalled directly.

Versatile diagnostic options enables the choice of the best possible measurement place and error-free operation of the measurement system.

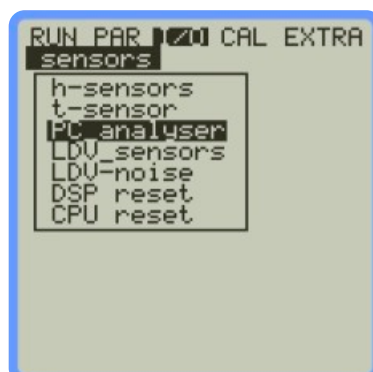

The input status can be recalled directly for diagnostic purposes.

On-site from anywhere

The NivuChannel offers innovative communication options for remote maintenance, remote diagnosis and data transfer as standard. This is how to interconnect the latest measurement technology worldwide at any time.

Using its **integrated web server** the NivuChannel provides a dedicated web-site using TCP/IP. Besides of being used within internal networks this option allows to connect the unit to the world wide web. Due to the specially designed operating system the unit is absolutely resistant to virus attacks. Internet connection allows to maintain, control and analyse several measurement places from anywhere in the world simultaneously.

To meet the requirements to state-of-the-art measurement systems the NivuChannel provides communication options for remote maintenance, remote diagnostics and data transfer using various communication channels on www.nivus.com.

- Measurement online
- D2W - Device to Web Internet portal

- Complies with worldwide interface standard using TCP/IP Ethernet
- Integrated web server
- Online access via Internet browser without the need to install additional software
- Permanent online via GPRS
- Integrated data logger for high data reliability
- Saved data can be read out via Internet at any time
- Quick and comprehensive remote diagnosis of entire measurement place (online service)

NivuChannel
get a grip on your
measurement place
www.nivus.com

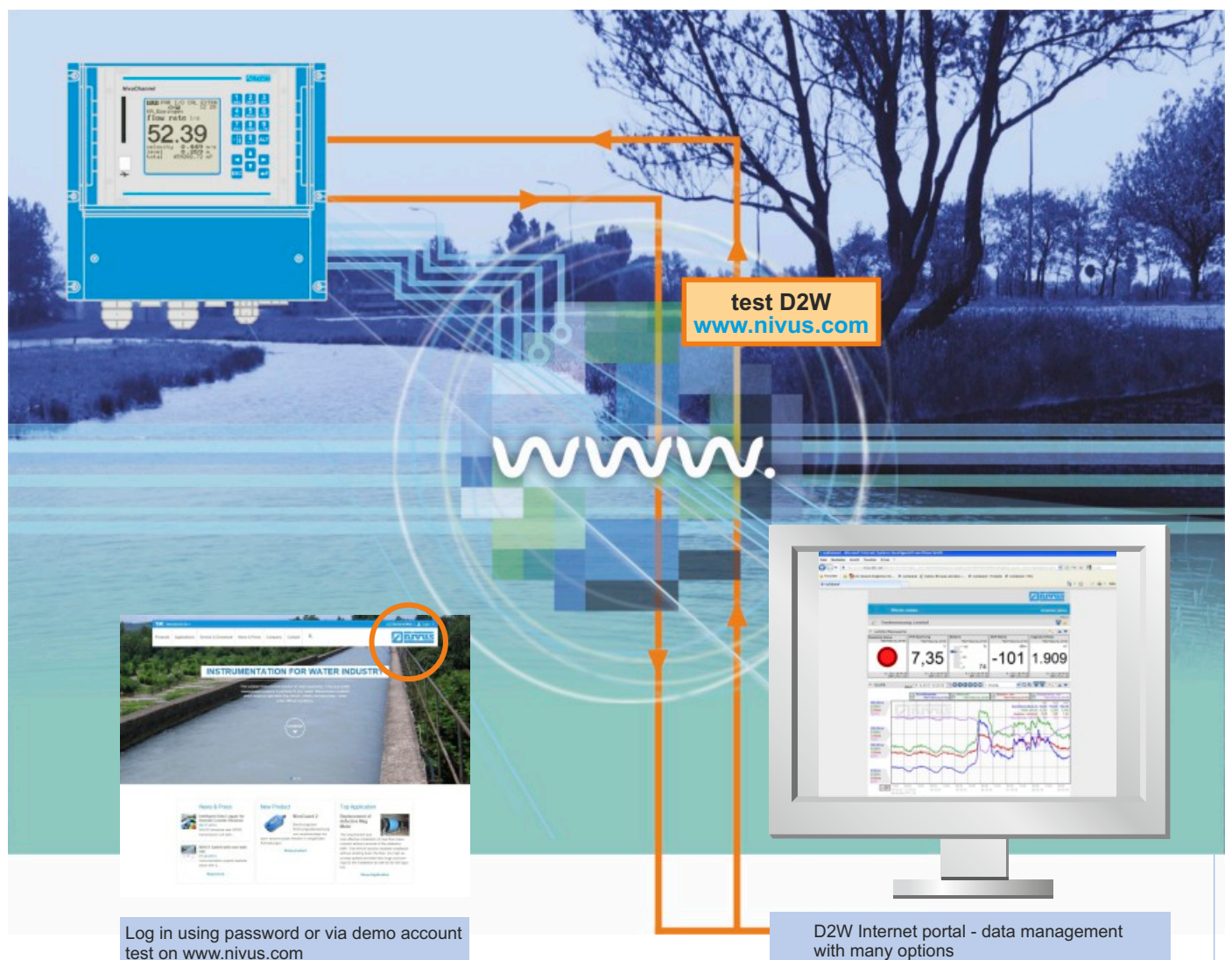

NivuChannel Transmitter

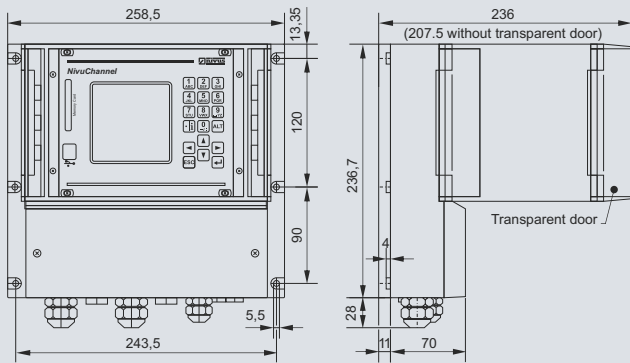

Transmitter

Power supply	100 to 240 V AC or 24 V DC
Power consumption	max. 48 VA
Wall mount enclosure	material: Polycarbonate
Transmitter	protection: IP 65 weight: approx. 3400 g
Operating temperature	-20° C to +50° C
Display	back-lit display, 128 x 128 pixels
Operation	18 keys, multilingual menus
Inputs	<ul style="list-style-type: none"> 4 x 0/4 - 20 mA with 12 bit resolution for external level 4 digital inputs 2 sensor pairs directly connectable or up to 8 sensor pairs connectable via adapter box
Outputs	<ul style="list-style-type: none"> 4 x 0/4 - 20 mA, load 500 Ohm, 12 bit resolution, accuracy $\pm 0.1\%$ 5 relays (SPDT), maximum load up to 230 V AC / 2 A ($\cos \varphi 0,9$) RJ45 for Internet communication
Data memory	compact flash card up to 128 MB
Data transmission	via compact flash card, Modbus TCP via Ethernet, with integrated web server, connection to local area networks (LAN) and wide area networks (WAN, Internet), Internet via Ethernet or optional internal ISDN, GPRS- or analog modem

Adapter box for connection to transmitter

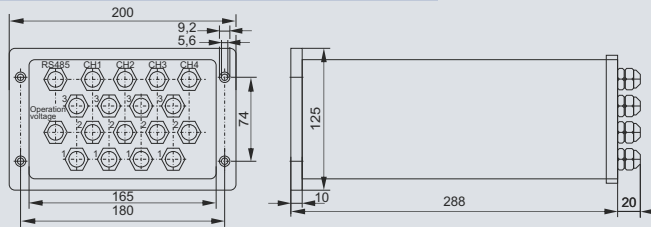

Adapter box

Power supply	100 to 240 V AC or 24 V DC
Power consumption	max. 48 VA
Enclosure	aluminium die-cast, protection: IP 65
Operating temperature	-20° C to +50° C
Inputs	1 to 8 measurement paths (sensor pairs)
Outputs	connection to transmitter
Accessories	<ul style="list-style-type: none"> type: LiYC11Y 2 x 1.5 mm² + 1 x 2 x 0.34 mm² outer cable diameter: 8.4 mm ± 0.25 mm

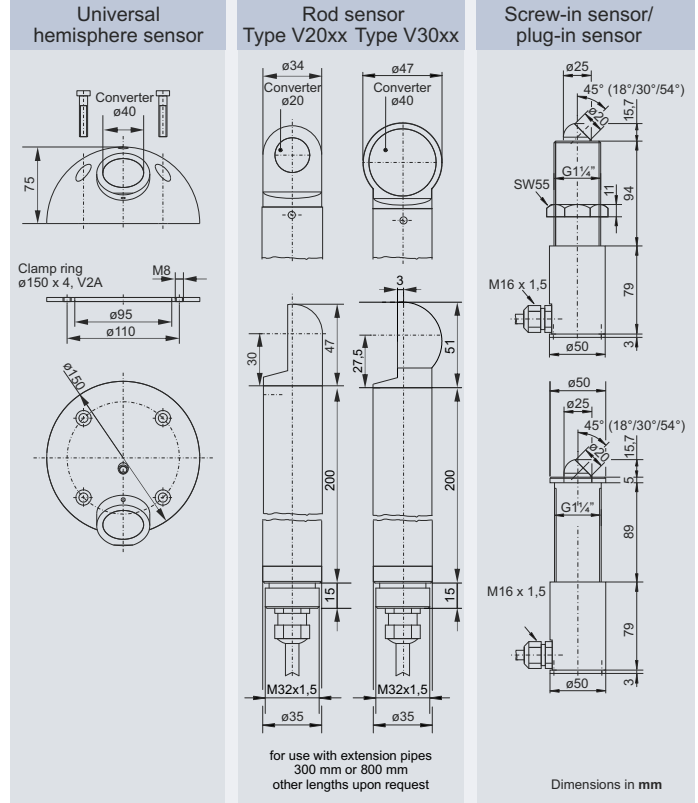

Sensors

Measurement principle	ultrasonic transit time and profile measurement with digital pattern detection
Flow velocity measurement	
Measurement range	flow velocity ± 15 m/s
Channel widths	0.5 m to 40 m; other widths upon request
Measurement uncertainty	<ul style="list-style-type: none"> flow velocity ($v_{average}$) $\pm 0.1\%$ of measurement value within path flow (Q) $\pm 0.5\%$, depending on measurement and margin conditions offset velocity $< \pm 5$ mm/s
Number of measurement paths	1 to 8 measurement paths; according to DIN EN ISO 6416:2004 and IEC 60041 (ASME PTC 18) (adapter box required if using more than 2 paths)
Measurement frequency	1 MHz; (other frequencies depending on path length)
Protection	IP 68
Operating temperature	-20° C to +50° C
Cable length	max. 100 m, can be extended to 200 m using adapter box
Cable type	<ul style="list-style-type: none"> uninterrupted pre-configured cable pre-configured cable with underwater plug and socket
Medium contacting materials	<ul style="list-style-type: none"> Screw-in sensor/plug-in sensor and rod sensor: stainless steel 1.4571, CFK (Carbon), Viton® hemisphere: stainless steel 1.4571, CFK (Carbon), POM, PUR, (plug and socket made of Neoprene)
Temperature measurement using velocity of sound	
Measurement uncertainty	0° C to +60° C
Accuracy	± 1 K

The specifications above are extracts from the complete documentation. You can find the complete specifications on our data sheets.

NIVUS GmbH
Head office
 Im Taele 2
 75031 Eppingen, Germany
 Phone: +49 (0)7262 9191 0
 Fax: +49 (0)7262 9191 999
 E-mail: info@nivus.com
 Internet: www.nivus.com

NIVUS AG
 87500 Glarus, Switzerland
 Phone: +41 (0)55 6452066
 E-mail: swiss@nivus.com

NIVUS Austria
 3382 Loosdorf, Austria
 Phone: +43 (0)2754 567 63 21
 E-mail: austria@nivus.com

NIVUS Sp. z o.o.
 81-212 Gdynia, Poland
 Phone: +48 (0)58 7602015
 E-mail: poland@nivus.com

NIVUS France
 67770 Sessenheim, France
 Phone: +33 (0)3 880716 96
 E-mail: france@nivus.com

NIVUS Ltd. (UK)
 Leamington Spa, Warwickshire
 Phone: +44 (0)1926 632470
 E-mail: info@nivus.com

NIVUS Ltd. (UK)
 Eaglescliffe, Cleveland
 Phone: +44 (0)1642 659294
 E-mail: info@nivus.com

NIVUS Middle East (FZE)
 Sharjah Free Zone, UAE
 Phone: +971 6 55 78 224
 Middle-East@nivus.com

NIVUS Korea Co. Ltd.
 Gyeonggi-Do 415-843
 Phone: +82 31 999 5920
 E-mail: korea@nivus.com